



KW TRADE SP. Z O.O.

**office**  
**school**  
**creativity**

**biuro szkola krecacja**

Szanowni Państwo!

Oto nasz najnowszy katalog – dzielimy się tu z Wami produktami, które już znacie, ale też mocną grupą nowości. Przyjemnego odkrywania!

We are pleased to present the new edition of our catalog. You can find our classics here, but a great bunch of novelties as well. Have a nice trip throughout it!



Marka własna KW trade – znana na rynku gama artykułów biurowych.

KW trade's own brand – wide range of office supplies well known on the market.



Marka własna KW trade obejmująca produkty szkolne, kreatywne i dla młodszych dzieci.

KW trade's own brand that offers school products, creative accessories and products for kids.



Marka własna KW trade oferująca artykuły piśmienne wysokiej jakości.

KW trade's own brand offering high quality writing instruments.



Marka własna KW trade, która obejmuje wysokiej jakości kalkulatory o dożywotniej gwarancji.

KW trade's own brand which includes high quality calculators of lifetime warranty.



Marka własna KW trade obejmująca zaawansowane technologicznie produkty: papiery fotograficzne oraz artykuły czyszczące do elektroniki.

KW trade's own brand of technologically advanced products: photo papers and cleaning articles for electronics.



Marka własna KW trade – wyjątkowa masa plastyczna przeznaczona dla dzieci.

KW trade's own brand – unusual modeling clay, addressed to children.



Szeroka gama artykułów: kleje i produkty kreatywne uznane na rynkach światowych. KW trade jest wyłącznym przedstawicielem tej marki w Polsce.

Wide range of articles: glues and creative products are well-known in the world. KW trade is the exclusive representative of this brand in Poland.



Uznana od wielu lat na świecie marka artykułów biurowych. KW trade jest wyłącznym przedstawicielem tej marki w Polsce.

Brand of office products, recognized for many years throughout the world. KW trade is the exclusive representative of this brand in Poland.



Wysokiej jakości produkty kreatywne dla dzieci, produkowane we Włoszech.

High quality creative products for children, made in Italy.



Włoski producent artykułów do pisania.

Italian manufacturer of writing utensils.



Jeden z największych na świecie producentów innowacyjnych korektorów w pisaku oraz w taśmie.

One of the world's largest producers of innovative correction tapes and pens.



Producent artykułów dla artystów.

The manufacturer of products for artists.

## Wspólnie dla DZIECI

Pajacyk to program, w ramach którego Polska Akcja Humanitarna od 1998 roku pomaga dzieciom i młodzieży w Polsce. Pajacyk finansuje posiłki i działania na rzecz ochrony zdrowia psychicznego; celem programu jest zdrowie i prawidłowy rozwój każdego dziecka.

Kupując produkty AMOS i FIORELLO, włączasz się w te działania.



## Wspólnie dla ŚRODOWISKA

Akcja wymiany pustych tubek na kleje AMOS trwa. Proste zasady, atrakcyjna nagroda, a dla dzieci dobra zabawa i jednocześnie nauka odpowiedzialności. Teraz w programie mogą uczestniczyć nie tylko szkoły i placówki opiekuńcze, ale także biura, sklepy czy urzędy.



## Rozwój i zabawa

Wspólnie z kreatywnymi rodzicami od lat inspirujemy do zabaw plastycznych: proste składniki, świetny pomysł – to przepis na udany czas z dzieckiem. Odwiedzaj fiorelki.pl!



FiorelloPolska  
klej AMOS



**dziurkacze i zszywacze, artykuły metalowe**  
punches & staplers, metal accessories

5

**organizacja dokumentów**  
office organizing

41

**kleje i taśmy**  
glues & tapes

67

**biurowe i szkolne**  
office & school

79

**papiernicze**  
paper

113

**kalkulatory, artykuły czyszczące**  
calculators & cleaning products

129

**korekcyjne i piśmienne**  
correction & writing

141

**plastyczne**  
creative

177

**artystyczne**  
arts

263

**nowości**  
novelties





274

## dziurkacze i zszywacze, artykuły metalowe

### punches & staplers, metal accessories

 25 ilość zszywanych/ dziurkowanych kartek punched/stapled sheets	 5,5 mm dziurkacze: średnica dziurki punches: hole diameter	 24/6 26/6 zszywacze: odpowiednie zszywki staplers: suitable staples	 zszywacze: zszywanie zamknięte staplers: closed stapling
 3 lata okres gwarancji guarantee	 80 mm dziurkacze: odległość dziurek punches: hole distance	 76 mm zszywacze: głębokość zszywania staplers: insertion depth	 zszywacze: zszywanie zamknięte, otwarte staplers: open, closed stapling
		 zszywacze: podstawa magnetyczna staplers: magnetic base	 zszywacze: zszywanie zamknięte, otwarte, tapicerskie staplers: open, closed, nailed stapling

## organizacja dokumentów office organizing

 A4 format format	 PP materiał: polipropylen material: polypropylene	 5 ilość szuflad drawers	 zamykane na klucz locking: key
 10 ilość koszułek pockets			

## kleje i taśmy glues & tapes

 CE zgodne z wymaganiami UE conforms to EU regulations	 AP zgodne z normą ASTM D-4236 conforms to ASTM D-4236	 PVP zawiera PVP contains PVP	 zmywalny washable
 19x33 taśma tape podajniki taśmy: wymiary taśmy tape dispensers: tape dimensions	 -30-100 °C taśma pakowa: zakres temperatur packing tape: temperature range	 3 lata okres gwarancji guarantee	

## biurowe i szkolne office & school

 CE zgodne z wymaganiami UE conforms to EU regulations	 nożyczki: końcówki ostre scissors: pointy tips	 nożyczki: końcówki okrągłe scissors: round tips	 nożyczki: końcówki zaokrąglone scissors: round tips
 nożyczki: z linijką scissors: with ruler	 5,25" rozmiar size	 13 cm rozmiar size	 dla leworęcznych for left-handed
 noże do papieru: szerokość ostrza paper knives: blade width	 12 części parts noże do papieru: łamanie ostrza paper knives: blade division	 10,5 mm kreda: średnica chalk: diameter	 20 cm zestawy geometryczne: długość linijki drawing sets: ruler length

## papiernicze paper

 drukarki atramentowe ink jet	 drukarki laserowe laser jet	 kserokopiarki copiers	 QCT Quatro Clean Technology	 5760 dpi maksymalna rozdzielczość druku max printing resolution	 260 g/m <sup>2</sup> gsm gramatura paper weight
 25 ilość arkuszy sheets	 A4 format format				

## kalkulatory, artykuły czyszczące

### calculators & cleaning products

 zasilanie bateryjne power: battery	 zasilanie bateryjne i słoneczne power: battery, solar	 12 pozycji digits display	
 uchylny wyświetlacz adjustable display	 uchylna podstawa adjustable support	 wodoodporny waterproof	
 200 ml artykuły czyszczące: pojemność cleaning supplies: capacity	 100 chusteczki czyszczące: ilość cleaning cloths: quantity	 CE zgodne z wymaganiami UE conforms to EU regulations	

 % obliczanie procentu percentage	 √ obliczanie pierwiastka square root	 M pamięć memory	 +/- klawisz zmiany znaku sign change key	 00 podwójne zero double zero	 000 potrójne zero triple zero	 GT suma ogólna total sum	 TAX obliczenia podatkowe tax calculations
--	--	---	--	--	---	--	---









## korekcyjne i piśmienne correction & writing

 0.5 mm grubość linii line thickness	 7 ml pojemność capacity	 5 mm 6 m taśma korekcyjna: szerokość, długość correction tape: width, length	 5 lat years okres gwarancji guarantee
 1500 m długość pisania writing length	 kolor tuszu ink color	 długopis wielokolorowy multicolor pen	 tusz wodoodporny waterproof ink
 przekrój sześciokątny hexagonal cross-section	 przekrój trójkątny triangular cross-section	 przekrój owalny oval cross-section	 ołówek z gumką pencil with eraser
 HB twardość grafitu lead hardness	 markery: końcówka zaokrąglona markers: round tip	 markery: końcówka ścięta markers: chisel tip	

## plastyczne creative

 CE zgodne z wymaganiami UE conforms to EU regulations	 AP zgodne z wymaganiami ACM Institute INC. USA conforms to AMC Institute INC. USA	 przekrój trójkątny triangular cross-section	 przekrój sześciokątny hexagonal cross-section
 ostrzone sharpened	 3 mm średnica grafitu lead diameter	 8 mm kredka okrągła: średnica round crayon: diameter	 11 mm kredka trójkątna: średnica triangular crayon: diameter
 2 mm grubość linii line thickness	 180 m długość pisania writing length	 Ø8 mm rozmiar stempla stamp diameter	 zmywalne washable
 6 mm 4 m taśma wzorki: szerokość, długość pattern tape: width, length	 pędzle szkolne okrągłe round school brushes	 1-6 rozmiar size rozmiary pędzli brushes' sizes	 ruchome oczka: magnetyczne wiggly eyes: magnetic

## artystyczne arts

 pędzle precyzyjne precision brushes	 pędzle okrągłe round brushes	 pędzle płaskie flat brushes	 2, 4, 6, 8, 12 rozmiar size rozmiary pędzli brushes' sizes
 5,6 mm średnica diameter	 3 mm średnica grafitu lead diameter	 6B twardość grafitu lead hardness	 300 g/m <sup>2</sup> gsm gramatura paper weight
 A4 format format			

# dziurkacze – tabela cech punches – comparison

SYMBOL SYMBOL	MATERIAL MATERIAL	KARTEK SHEETS		ROZSTAW DZIUREK HOLE DISTANCE	ŚREDNICA DZIURKI HOLE DIAMETER	LISTWA FORMATOWA GUIDE BAR	PODSTAWA BASE	STR. PAGE
		80 g/m <sup>2</sup>	60 g/m <sup>2</sup>					
9201P Jednodziurkowy single hole	metalowy metal	6			6 mm	-		20
709	metalowy metal	8		80 mm	6 mm	-	111x57 mm	19
709R	metalowy metal	8	15	80 mm	6 mm	3*8; S: A4 A5 A6 B5 B6; E: A4 B5 B6	111x57 mm	19
5530 Energy	metalowy metal	8		80 mm	6 mm	-	108x60 mm	9
707A	metalowy metal	10		80 mm	5,5 mm	-	108x66,5 mm	19
P6068B	metalowy metal	10		80 mm	6 mm	-	103x50 mm	23
TYP862 Hal	metalowa konstrukcja metal const.	10		80 mm	6 mm	A4 A5 A6	117x96 mm	6
P5024B Alpha	metalowa konstrukcja metal const.	10		80 mm	5,5 mm	3*8; S: A4 A5 A6 B5; E: A3 A4 B6	123x74 mm	14
837S	metalowa konstrukcja metal const.	12		80 mm	5,5 mm	3*8; S: A4 A5 A6 B5 B6; E: A3 A4 B4 B5	112x63 mm	18
706	metalowy metal	15		80 mm	5,5 mm	3*8 A6 FOL3*8 A5 A4	125x82 mm	20
9401	metalowy metal	15		80/240 mm	5,5 mm	3*8 A6 FOL3*8 A5 A4	285,5x91 mm	21
TYP602 ColorTouch	metalowa konstrukcja metal const.	16		80 mm	6 mm	S: A4 B5 A5 B6; E: A3 B4 A4 B5 A5	123x58 mm	7
P5180M Dynamic	metalowa konstrukcja metal const.	20		80 mm	5,5 mm	3*8 A6 F3*8 A5 US A4	125,5x88 mm	10
P6088B Galaxy	metalowy metal	20		80 mm	6 mm	3*8 A6 F3*8 A5 US A4	130,5x97,5 mm	16
837	metalowa konstrukcja metal const.	25	32	80 mm	5,5 mm	A4 A5 A6	124,5x83 mm	18
837L	metalowa konstrukcja metal const.	25		80/70 mm	5,5 mm	8-A6 8-A5 8-A4	130x111 mm	18
P6108B	metalowy metal	25	35	80 mm	5,5 mm	A4 A5 A6	124,7x83 mm	20
5531 Energy	metalowy metal	25		80 mm	6 mm	A4, A5, A6	109x106 mm	9
701	metalowy metal	30	40	80 mm	6 mm	S: A4 B5 A5 B6 A6 B7; E: A3 B4 A4 B5 A5 B6	149x179,3 mm	21
P5180L Dynamic	metalowa konstrukcja metal const.	30		80 mm	5,5 mm	3*8 A6 F3*8 A5 US A4	126x106,5 mm	10
837XL	metalowa konstrukcja metal const.	40		70/80 mm	6 mm	A4 A5 A6	162,5x130 mm	18
P6089B Galaxy	metalowy metal	40		80 mm	6 mm	3*8 A6 F3*8 A5 US A4	143,5x118 mm	16
P5161B Save Force	metalowa konstrukcja metal const.	45		80 mm	5,5 mm	3*8 A6 F3*8 A5 US A4	155x131 mm	12
P6090B Galaxy	metalowy metal	60	75	80 mm	6 mm	3*8 A6 F3*8 A5 US A4	190,5x131 mm	16
P7123	metalowy metal	65		80 mm	5 mm	3*8 A4 A5 F3*8 A6	199 x 112 mm	22
TY845R	metalowy metal	100		80 mm	6 mm	A3 A4 A5 B4 B5 B6	121x228 mm	22
BIN 04029	metalowy metal	300		80 mm	6 mm	A3 A4 A4-1 A4-2 A5 B4 B5 B6	326x133 mm	23

# zszywacze – tabela cech staplers – comparison

SYMBOL SYMBOL	MATERIAL MATERIAL	KARTEK SHEETS		GŁĘB. ZSZYW. INS. DEPTH	ZSZYWKI* STAPLES*	ZSZYWANIE STAPLING	PODSTAWA BASE	STR. PAGE
		80 g/m <sup>2</sup>	60 g/m <sup>2</sup>					
1001BDS	metalowa konstrukcja metal const.	8		46 mm	10#		95x21 mm	24
1011A	metalowa konstrukcja metal const.	8	15	34 mm	10#		97x21 mm	24
2001BD	metalowa konstrukcja metal const.	8		50 mm	10#		94x23 mm	24
5002	metalowa konstrukcja metal const.	10		52 mm	10#		105x42 mm	24
868	metalowa konstrukcja metal const.	10	20	19 mm	24/6, 26/6		56x23 mm	25
910B	metalowa konstrukcja metal const.	10		68 mm	24/6, 26/6		135x32 mm	25
930B	metalowa konstrukcja metal const.	10		68 mm	24/6, 26/6		142x37 mm	25
950L	metalowy metal	10	30	300 mm	24/6, 26/6		38,3x46 mm	27
828L nożycowy plier	metalowy metal	12		56 mm	24/6, 26/6		176x25 mm	29
9628 obrotowy swivel arm	metalowy metal	12		90 mm	24/6, 26/6		148x41 mm	28
414 obrotowy swivel arm	metalowy metal	12		100 mm	24/6		136x58 mm	28
S5027B Alpha	metalowa konstrukcja metal const.	15		19 mm	24/6, 26/6		62x32 mm	15
S5072B	metalowa konstrukcja metal const.	15		40 mm	24/6, 26/6		110x30 mm	23, 25
S5148 In-Touch	metalowa konstrukcja metal const.	15		21 mm	24/6, 26/6		63x32 mm	7
EG-1610USB automatyczny automatic		15		10 mm	24/6, 26/6		130x56 mm	29
204	metalowy metal	20		59 mm	24/6, 26/6		137x35 mm	26
205	metalowy metal	20	30	51 mm	24/6, 26/6		116x34 mm	26
208	metalowy metal	20		54 mm	24/6, 26/6		131x38 mm	26
4001BD	metalowa konstrukcja metal const.	20		68 mm	24/6, 26/6		131x33 mm	26
TYS1208 Hal	metalowa konstrukcja metal const.	20		67 mm	24/6, 26/6		58x25 mm	6
TYS16101B ColorTouch	metalowa konstrukcja metal const.	20		50 mm	24/6, 26/6		116x36 mm	7
TYS16102B ColorTouch	metalowa konstrukcja metal const.	20		70 mm	24/6, 26/6		150x36 mm	7
TYS1030 Save Force	metalowa konstrukcja metal const.	20		37 mm	24/6, 26/6		85x32 mm	13
S5023B Alpha	metalowa konstrukcja metal const.	20		48 mm	24/6, 26/6		115x33 mm	15
S5065B Alpha	metalowa konstrukcja metal const.	20		54 mm	24/6, 26/6		148x43 mm	15
S5104 Dynamic	metalowa konstrukcja metal const.	20		57 mm	24/6, 26/6		166x46 mm	11
S5105 Dynamic	metalowa konstrukcja metal const.	20		51 mm	24/6, 26/6		137x43 mm	11
S5131B Omax	metalowa konstrukcja metal const.	20		32 mm	24/6, 26/6		111x30 mm	27
S5146 In-Touch	metalowa konstrukcja metal const.	20		76 mm	24/6, 26/6		166x40 mm	8
S5147 In-Touch	metalowa konstrukcja metal const.	20		45 mm	24/6, 26/6		104x36 mm	8
S6085B Galaxy	metalowy metal	20		65 mm	24/6, 26/6		130x34 mm	17
S6086B Galaxy	metalowy metal	20		77 mm	24/6, 26/6		164x38 mm	17
5001 Energy	metalowa konstrukcja metal const.	20		35 mm	24/6, 26/6		81x29,5 mm	9
S10061B Jet Stapler	metalowa konstrukcja metal const.	25		40 mm	24/6, 26/6		176x23 mm	29
S5025B Alpha	metalowa konstrukcja metal const.	25		50 mm	24/6, 26/6		182x41 mm	15
S5173 SoFTouch	metalowa konstrukcja metal const.	25		36 mm	24/6, 26/6		150x37 mm	12
S6083B Galaxy	metalowy metal	25		51 mm	24/6, 26/6		107x31 mm	17
S6120B Axa	metalowa konstrukcja metal const.	28		63 mm	24/6, 26/6		127x35 mm	27
S5160B Save Force	metalowa konstrukcja metal const.	30		50 mm	24/6, 26/6		140x38 mm	13
S5180 Save Force	metalowa konstrukcja metal const.	50		50 mm	24/6, 26/6, 23/6, 23/8		145x36 mm	13
S6030B Alpha	metalowa konstrukcja metal const.	60		61 mm	23/10		270x69 mm	15
TYSFT843	metalowa konstrukcja metal const.	100		60 mm	23/6, 23/08, 23/10, 23/13		304x76 mm	30
8538	metalowy metal	100		69 mm	23/6, 23/08, 23/10, 23/13, 23/15		300x88 mm	31
938	metalowy metal	100	150	69 mm	23/6, 23/08, 23/10, 23/13, 23/15		281x72 mm	30
8539	metalowy metal	200		64 mm	23/6, 23/8, 23/10, 23/13, 23/15, 23/17, 23/20, 23/23		310x83 mm	31
939	metalowy metal	200		64 mm	23/6, 23/8, 23/10, 23/13, 23/15, 23/17, 23/20, 23/23		310x82 mm	30

\* UŻYCIE ZSZYWEK 26/6 ZWIĘKSZA ILOŚĆ ZSZYWANYCH KARTEK

\* USING 26/6 STAPLES INCREASES STAPLED SHEETS QUANTITY

**punches & staplers metal accessories**  
**dziurkacze zszywacze artykuły metalowe**



# koloroterapia

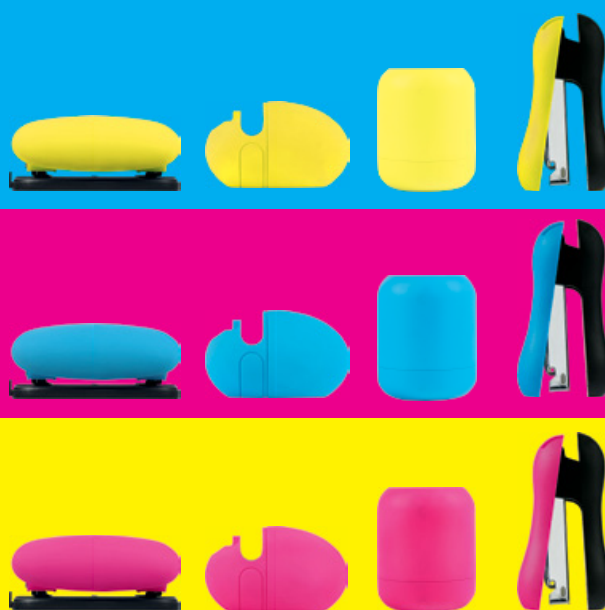

**EAGLE**

**Ha!**

**Linia Ha!**: Optywowe kształty, wyraziste kolory, matowe pokrycie soft – seria Ha! sprawdzi się wszędzie tam, gdzie potrzebny jest wyrazisty akcent.

Ha! collection: smooth shape, expressive colors, matte soft cover – the Ha! series is perfect whenever a distinctive accent is needed.

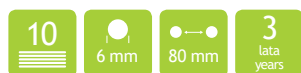

**Ha!**

pojemnik na długopisy – s. 51  
pen holder – see p. 51



**Ha!**

uchwyt do taśmy – s. 75  
tape dispenser – see p. 75

## Dziurkacz Ha! TYP862

- metalowa konstrukcja
- obudowa z tworzywa
- pojemnik na odpady z tworzywa sztucznego nierysującego podłoża
- ramię antypoślizgowe
- listwa formatowa
- wskaźnik środka strony

## Punch Ha! TYP862

- metal construction, lever made of durable material
- waste container made of non-abrasive material
- non-slip arm
- page center indicator
- guide bar

INDEKS INDEX KOLOR COLOR

110-1693 ● niebieski blue

110-1694 ● różowy pink

110-1695 ● żółty yellow

EAN BARCODE



## Zszywacz Ha! TYS1208

- stojący
- metalowa konstrukcja
- obudowa z tworzywa
- antypoślizgowe ramię
- mechanizm umożliwiający łatwe ładowanie zszywek
- wskaźnik ilości zszywek

## Stapler Ha! TYS1208

- stand-up
- metal construction, casing made of durable material
- non-slip arm
- easy loading mechanism
- staples residue indicator



INDEKS INDEX KOLOR COLOR

110-1690 ● niebieski blue

110-1691 ● różowy pink

110-1692 ● żółty yellow

EAN BARCODE



**Linia COLORtouch:** Energetyczne kolory, charakterystyczny czarny znak na obudowie – seria COLORtouch daje gwarancję ciekawego i funkcjonalnego urządzenia niezależnie od tego, gdzie jest teraz Twoje biuro.



**ColorTouch! collection:** vivid colors & distinctive black element on the casing – the COLORtouch series guarantees interesting and functional devices no matter where your office currently is.



## Dziurkacz COLORtouch TYP6602

- metalowa konstrukcja, obudowa z tworzywa ABS
- antypoślizgowe ramię z metalowym wzmocnieniem
- pojemnik na odpady z tworzywa sztucznego nierysującego podłoża
- listwa formatowa
- wskaźnik środka strony

## Punch COLORtouch TYP6602

- metal construction, lever made of ABS material
- non-slip arm with metal reinforcement
- waste container made of non-abrasive material
- page center indicator
- guide bar



INDEKS	INDEX	KOLOR	COLOR
110-1687		niebieski	blue
110-1688		różowy	pink
110-1689		żółty	yellow

### EAN BARCODE



## Zszywacze COLORtouch

- metalowa konstrukcja, obudowa z tworzywa
- antypoślizgowe ramię
- wskaźnik ilości zszywek

## Staplers COLORtouch

- metal construction, casing made of durable material
- non-slip arm
- staples residue indicator

### TYST6101B

INDEKS	INDEX	KOLOR	COLOR
110-1681		niebieski	blue
110-1682		różowy	pink
110-1683		żółty	yellow



### EAN BARCODE



### TYST6102B

INDEKS	INDEX	KOLOR	COLOR
110-1684		niebieski	blue
110-1685		różowy	pink
110-1686		żółty	yellow



### EAN BARCODE





in·Touch

**Linia In-Touch:** piękno prostoty. Seria Eagle o eleganckiej linii i charakterystycznej kolorystyce: biało-czarne lub czarno-pomarańczowe zszywacze idealne do nowoczesnego wnętrza. Duża płaska powierzchnia umożliwia wykorzystanie produktów pod nadruk reklamowy.

**In-Touch collection:** the beauty of simplicity. EAGLE series of elegant design and distinctive colors: black&white or black&orange staplers perfect for modern office. Large flat surface enables advertising imprint.



### Zszywacze In-Touch

- metalowa konstrukcja
- obudowa z trwałego tworzywa
- wskaźnik ilości zszywek

### Staplers In-Touch

- metal construction
- casing made of durable material
- staples residue indicator



### S5146

INDEKS INDEX KOLOR COLOR

- 110-1591 biało-czarny black&white
- 110-1592 czarno-pomarańczowy black&orange

EAN BARCODE



### S5147

INDEKS INDEX KOLOR COLOR

- 110-1593 biało-czarny black&white
- 110-1594 czarno-pomarańczowy black&orange

EAN BARCODE



### S5148

INDEKS INDEX KOLOR COLOR

- 110-1595 biało-czarny black&white
- 110-1596 czarno-pomarańczowy black&orange

EAN BARCODE



**Linia Energy:** wyraż się kolorem. Modne, energetyczne połączenie barw podkreśli nowoczesny charakter biura.

**Energy line:** express your power with colors. Trendy energetic set of colors fits in modern office.



## Dziurkacze Energy

- metalowe dziurkacze
- wskaźnik środka strony
- blokada ramienia ułatwiająca przechowywanie



**5530**

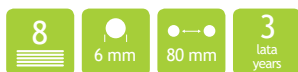

**INDEKS**  
INDEX

**KOLOR**  
COLOR

**EAN**  
BARCODE

★ 110-1647    ● Energy    5 903364 204990

★ do wyczerpania zapasów while stock lasts

## Punches Energy

- metal punches
- page center indicator
- lever lock for convenient storage



**5531**

- listwa formatowa
- guide bar

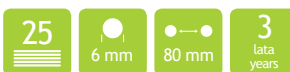

**INDEKS**  
INDEX

**KOLOR**  
COLOR

**EAN**  
BARCODE

★ 110-1646    ● Energy    5 903364 204976

★ do wyczerpania zapasów while stock lasts

## Zszywacz Energy

- metalowa konstrukcja
- obudowa z trwałego tworzywa
- wskaźnik ilości zszywek
- redukcja siły nacisku do 50%
- wbudowany rozszywacz

**5001**



**INDEKS**  
INDEX

**KOLOR**  
COLOR

**EAN**  
BARCODE

★ 110-1643    ● Energy    5 903364 205034

★ do wyczerpania zapasów while stock lasts

## Stapler Energy

- metal construction
- casing made of durable material
- staples residue indicator
- force reduction up to 50%
- integrated staple remover



**Linia Dynamic:** czarne dziurkacze i zszywacze z kolorowymi elementami, które nie dominują biurka, ale dyskretnie dodają mu charakteru.

**Dynamic collection:** black punches & staplers enriched with color elements will not outbalance the office desk but give it more character in a discreet way.



### Dynamic

temperówka automatyczna – s. 96  
automatic sharpener – see p. 96

### Dziurkacze Dynamic

- metalowa konstrukcja
- ergonomiczne ramie z trwałego tworzywa
- elementy wykończeniowe z tworzywa ABS
- pojemnik na ścinki nierysujący podłoża z tylną klapką ułatwiającą opróżnianie
- listwa formatowa oraz wskaźnik środka strony

### Punches Dynamic

- metal construction
- ergonomic lever made of durable material
- finishing elements made of ABS
- waste container made of non-abrasive material with back flap for easy emptying
- guide bar, page center indicator



### P5180M

INDEKS INDEX	KOLOR COLOR
110-1508	● czarny black
110-1516	● czerwony red
110-1515	● niebieski blue



#### EAN BARCODE



### P5180L

INDEKS INDEX	KOLOR COLOR
110-1507	● czarny black
110-1512	● czerwony red
110-1513	● niebieski blue



#### EAN BARCODE



## Zszywacze Dynamic

- czarne zszywacze z kolorowymi elementami
- metalowa konstrukcja, obudowa z trwałego tworzywa
- wskaźnik ilości zszywek

## Staplers Dynamic

- black staplers with color elements
- metal construction, casing made of durable material
- stapler residue indicator

**EAGLE**

**Dynamic**

### S5105

INDEKS INDEX	KOLOR COLOR
110-1510	● czarny black
110-1525	● czerwony red
110-1524	● niebieski blue



EAN BARCODE



### S5104

INDEKS INDEX	KOLOR COLOR
110-1509	● czarny black
110-1521	● czerwony red
110-1522	● niebieski blue



EAN BARCODE



**EAGLE****SOFTouch**

**SOFTouch:** proste zszywanie. Nowoczesna technologia pozwala zmniejszyć siłę potrzebną do zszywania dokumentów nawet o 50%! Klasyczna, biało-czarna kolorystyka sprawia, że SOFTouch będzie się świetnie prezentować na każdym nowoczesnym biurku.

**SOFTouch:** simple stapling. Modern technology helps to reduce force needed for stapling up to 50%! Classic black&white colors make it perfect for any modern desk.

## Zszywacz SOFTouch

- metalowa konstrukcja, obudowa z trwałego tworzywa
- antypoślizgowe, gumowe elementy w podstawie
- ramię wyposażone w zdejmowalną, półprzezroczystą nakładkę, pod którą można umieścić podpis
- wskaźnik ilości zszywek



## Stapler SOFTouch

- metal construction, casing made of durable material
- non-slip rubber elements in base
- removable transparent cap with place for signature on arm
- staples residue indicator

### S5173



INDEKS INDEX KOLOR COLOR

110-1598

● biało-czarny black&white

EAN BARCODE

**EAGLE****SAVE FORCE**

**Linia SAVE FORCE** to produkty wykonane w nowoczesnej, zaawansowanej technologii.

Najważniejszy atut to redukcja siły nacisku do 50%. Dzięki temu zszywanie i dziurkowanie większej ilości kartek nie będzie już sprawiało problemu – stanie się przyjemnością.

**SAVE FORCE collection** consists of advanced modern technology products. The most important asset is reducing force needed for punching or stapling up to 50%. Punching and stapling of multiple sheets is no longer an effort – it becomes a pleasure.

## Dziurkacz Save Force P5161B

- stabilna metalowa konstrukcja
- elementy wykończeniowe z trwałych tworzyw sztucznych
- listwa formatowa
- wskaźnik środka strony
- blokada ramienia ułatwiająca przechowywanie
- zintegrowany pojemnik na ścinki nierysujący podłoża
- z tylną klapką ułatwiającą opróżnianie
- redukcja siły nacisku do 50%



## Punch Save Force

- stable metal construction
- finishing elements made of durable material
- guide bar
- page center indicator
- lever lock for convenient storage
- integrated waste container made of non-abrasive material with back flap for easy emptying
- force reduction up to 50%

### P5161B



INDEKS INDEX KOLOR COLOR

110-1491

● czarny black

110-1492

● niebieski blue

EAN BARCODE



## Zszywacze Save Force

- stabilna metalowa konstrukcja
- elementy wykończeniowe z trwałych tworzyw sztucznych
- wskaźnik ilości zszywek pozostałych w magazynku
- redukcja siły nacisku do 50%

## Staplers Save Force

- stable metal construction
- finishing elements made of durable material
- staples residue indicator
- force reduction up to 50%



**SAVE FORCE**

### S5180

- guzik do łatwego uzupełniania zszywek
- wbudowany wyciągacz zszywek
- push button for easy front staple loading
- integrated staple remover



INDEKS INDEX	KOLOR COLOR	EAN BARCODE
110-1675	● czarny black	5 903364 218300

### S5160B

- system płaskiego zaginania zszywek pozwala na zmniejszenie objętości zszywanych dokumentów nawet o 30%
- flat clinch stapling system reduces volume of sheets up to 30%



INDEKS INDEX	KOLOR COLOR	EAN BARCODE
110-1495	● czarny black	5 903364 216306
110-1496	● niebieski blue	5 903364 216320

### TYSS010

- pojemnik na zapasowe zszywki
- wbudowany wyciągacz zszywek
- 1000 zszywek w zestawie
- integrated staple storage case
- integrated staple remover
- 1000 staples included



INDEKS INDEX	KOLOR COLOR	EAN BARCODE
110-1676	● czarny black	5 903364 218607
110-1677	● czerwony red	5 903364 218669
110-1678	● niebieski blue	5 903364 218621
110-1679	● pomarańczowy orange	5 903364 218638

### TYST030

- pojemnik na zapasowe zszywki
- wbudowany wyciągacz zszywek
- integrated staple storage case
- integrated staple remover



INDEKS INDEX	KOLOR COLOR	EAN BARCODE
110-1696	○ biały white	5 903364 219444
110-1698	● niebieski blue	5 903364 219420
110-1697	● różowy pink	5 903364 219468





**EAGLE**  
*Alpha*

**Seria ALPHA** to duży wybór produktów sprawdzonych pod względem jakości i o klasycznym wyglądzie. Antypoślizgowe detale zapewniają pewny chwyt, a jednocześnie stanowią elementy dekoracyjne.

ALPHA series is a wide range of products well known for their high quality and classic design. Non-slip elements ensure comfortable grip and determine their bicolor appearance.



*Alpha*

temperówka automatyczna – s. 97  
automatic sharpener – see p. 97

## Dziurkacz Alpha

- metalowa konstrukcja
- obudowa z trwałego tworzywa
- pojemnik na odpady z tworzywa sztucznego nierysującego podłoża
- ramię antypoślizgowe
- podwójny wskaźnik środka strony
- listwa formatowa



## Punch Alpha

- metal construction
- casing made of durable material
- waste container made of non-abrasive material
- non-slip lever
- double page center indicator
- guide bar

### P5024B

INDEKS INDEX	KOLOR COLOR
110-1072	● czarny black
110-1073	● czerwony red
110-1074	● niebieski blue



EAN BARCODE



5 903364 208851



5 903364 209520

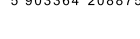

5 903364 208875

## Zszywacze Alpha

- metalowa konstrukcja, obudowa z trwałego tworzywa
- ramię antypoślizgowe
- wskaźnik ilości zszywek

## Staplers Alpha

- metal construction, casing made of durable material
- non-slip arm
- staples residue indicator



**S5065B**

- pojemnik na zapasowe zszywki
- integrated spare staples container



INDEKS INDEX	KOLOR COLOR	EAN BARCODE
110-1295	● czarny black	5 903364 210113
110-1297	● niebieski blue	5 903364 210137



**S5023B**

- pojemnik na zapasowe zszywki
- integrated spare staples container



INDEKS INDEX	KOLOR COLOR	EAN BARCODE
110-1284	● czarny black	5 903364 208936
110-1285	● czerwony red	5 903364 209469
110-1286	● niebieski blue	5 903364 208950



**S5027B**

- wbudowany rozszywacz
- integrated staple remover



INDEKS INDEX	KOLOR COLOR	EAN BARCODE
110-1291	● czarny black	5 903364 209018
110-1292	● czerwony red	5 903364 209421
110-1293	● niebieski blue	5 903364 209032



## S5025B nożycowy

- mechanizm nożycowy zapewni wygodę użytkowania
- uchwyt w obudowie: zawieszony na sznurku zszywacz jest zawsze pod ręką

### S5025B plier

- hanger provides comfort: stapler is always close at hand



INDEKS INDEX	KOLOR COLOR	EAN BARCODE
110-1287	● czarny black	5 903364 208974
110-1289	● niebieski blue	5 903364 208998



## S6030B

- płaski: wysokość tylko 92 mm, co ułatwia przechowywanie
- pojemnik na zapasowe zszywki

### S6030B

- flat: only 92 mm high for easy storage
- integrated spare staples container



INDEKS INDEX	KOLOR COLOR	EAN BARCODE
110-1311	● czarny black	5 903364 209056

## Dziurkacze Galaxy

- metalowe dziurkacze z antypoślizgowym elementem na ramieniu
- pojemnik na odpady z tworzywa sztucznego nierysującego podłoża
- listwa formatowa
- wskaźnik środka strony

## Punches Galaxy

- metal punches with non-slip element on lever
- waste container made of non-abrasive material
- guide bar
- page center indicator

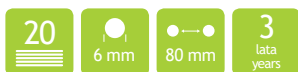

### P6088B

INDEKS INDEX	KOLOR COLOR
110-1083	● niebieski blue
110-1446	● grafitowy graphite



#### EAN BARCODE

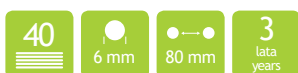

### P6089B

INDEKS INDEX	KOLOR COLOR
★ 110-1086	● niebieski blue
110-1447	● grafitowy graphite



#### EAN BARCODE



★ do wyczerpania zapasów while stock lasts

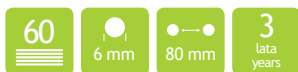

### P6090B

INDEKS INDEX	KOLOR COLOR
110-1448	● grafitowy graphite



#### EAN BARCODE



## Zszywacze Galaxy

- metalowe zszywacze
- wskaźnik ilości zszywek

## Staplers Galaxy

- metal staplers
- staples residue indicator



### S6086B

INDEKS INDEX	KOLOR COLOR
110-1317	● niebieski blue
110-1451	● grafitowy graphite



EAN BARCODE



### S6085B

INDEKS INDEX	KOLOR COLOR
110-1313	● czerwony red
110-1314	● niebieski blue
110-1450	● grafitowy graphite



EAN BARCODE



### S6083B

- nowy mechanizm ładowania zszywek
- upgraded loading mechanism

INDEKS INDEX	KOLOR COLOR
110-1396	● czerwony red
110-1398	● niebieski blue
110-1399	● żółty yellow
110-1449	● grafitowy graphite



EAN BARCODE



## Dziurkacze 837

- metalowa konstrukcja
- pojemnik na odpady z tworzywa sztucznego nierysującego podłoża
- podwójny wskaźnik środka strony (poza 837XL)
- listwa formatowa

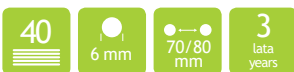
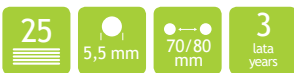
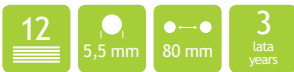

## Punches 837

- metal construction
- waste container made of non-abrasive material
- double page center indicator (except 837XL)
- guide bar

### 837S

- ergonomiczne ramię z trwałego tworzywa
- ergonomic lever made of durable material



#### INDEKS INDEX KOLOR COLOR

110-1042	● czarny	black
110-1043	● czerwony	red
110-1044	● niebieski	blue
110-1045	● szary	grey

#### EAN BARCODE

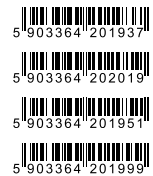

### 837

- ergonomiczne ramię z trwałego tworzywa
- ergonomic lever made of durable material



#### INDEKS INDEX KOLOR COLOR

110-1033	● czarny	black
110-1034	● czerwony	red
110-1035	● niebieski	blue
110-1036	● szary	grey

#### EAN BARCODE

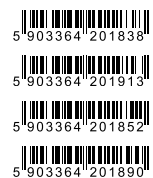

### 837L

- ergonomiczne ramię z trwałego tworzywa
- blokada ramienia ułatwia przechowywanie – ogranicza wysokość do 60 mm
- regulowany rozstaw otworów



- ergonomic lever made of durable material
- lever lock for convenient storage: only 60 mm high
- adjustable hole distance

#### INDEKS INDEX KOLOR COLOR

110-1038	● czarny	black
110-1039	● czerwony	red
110-1040	● niebieski	blue
110-1041	● szary	grey

#### EAN BARCODE



### 837XL

- metalowe ramię
- blokada ramienia ułatwia przechowywanie – ogranicza wysokość do 70 mm
- regulowany rozstaw otworów
- wskaźnik środka strony



- lever made of metal
- lever lock for convenient storage: only 70 mm high
- adjustable hole distance
- page center indicator

#### INDEKS INDEX KOLOR COLOR

110-1047	● czarny	black
110-1049	● niebieski	blue
110-1050	● szary	grey

#### EAN BARCODE



## Dziurkacz 709

- dziurkacz metalowy
- pojemnik na odpady z tworzywa sztucznego nierysującego podłoża
- wskaźnik środka strony

## Punch 709

- metal punch
- waste container made of non-abrasive material
- page center indicator



### INDEKS INDEX KOLOR COLOR

110-1023	● czarny	black
110-1024	● czerwony	red
110-1025	● niebieski	blue
110-1026	● szary	grey

### EAN BARCODE

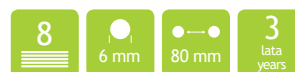

## Dziurkacz 709R

- dziurkacz metalowy
- pojemnik na odpady z tworzywa sztucznego nierysującego podłoża
- wskaźnik środka strony
- listwa formatowa

## Punch 709R

- metal punch
- waste container made of non-abrasive material
- page center indicator
- guide bar



### INDEKS INDEX KOLOR COLOR

110-1028	● czarny	black
110-1029	● czerwony	red
110-1030	● niebieski	blue
110-1031	● szary	grey

### EAN BARCODE



## Dziurkacz 707A

- dziurkacz metalowy
- pojemnik na odpady z tworzywa sztucznego nierysującego podłoża
- wskaźnik środka strony

## Punch 707A

- metal punch
- waste container made of non-abrasive material
- page center indicator



### INDEKS INDEX KOLOR COLOR

110-1013	● czarny	black
110-1014	● czerwony	red
110-1015	● niebieski	blue
110-1016	● szary	grey

### EAN BARCODE





## Dziurkacz 706

- dziurkacz metalowy
- pojemnik na odpady z tworzywa sztucznego nierysującego podłoża
- wskaźnik środka strony
- listwa formatowa

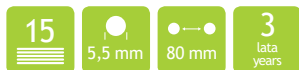

## Punch 706

- metal punch
- waste container made of non-abrasive material
- page center indicator
- guide bar



INDEKS INDEX	KOLOR COLOR
110-1007	● czarny black
110-1009	● niebieski blue
110-1010	● srebrny silver

### EAN BARCODE



## Dziurkacz P6108B

- dziurkacz metalowy
- antypoślizgowe ramię
- pojemnik na odpady z tworzywa sztucznego nierysującego podłoża
- wskaźnik środka strony
- listwa formatowa

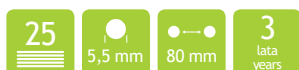

## Punch P6108B

- metal punch
- non-slip lever
- waste container made of non-abrasive material
- page center indicator
- guide bar



INDEKS INDEX	KOLOR COLOR
110-1070	● czarny black
110-1071	● niebieski blue

### EAN BARCODE



## Dziurkacz 9201P

- metalowy dziurkacz jednootworowy
- pojemnik na ścinki
- prowadnica ułatwiająca wsuwanie papieru



## Punch 9201P single hole

- metal construction
- waste container
- guide for easy paper insertion



INDEKS INDEX	KOLOR COLOR
110-1651	● czarny black

### EAN BARCODE



## Dziurkacz 9401

- dziurkacz metalowy 4-dziurkowy
- listwa formatowa
- dwa osobne pojemniki na odpady z tworzywa sztucznego nierysującego podłoża

## Punch 9401

- four-hole metal punch
- guide bar
- two separate waste containers made of non-abrasive material



INDEKS INDEX	KOLOR COLOR
110-1052	● czarny black
110-1054	● niebieski blue

EAN BARCODE



## Dziurkacz 701

- dziurkacz metalowy o dużej wytrzymałości
- pojemnik na odpady z tworzywa sztucznego nierysującego podłoża
- wskaźnik środka strony
- listwa formatowa

## Punch 701

- heavy duty metal punch
- waste container made of non-abrasive material
- page center indicator
- guide bar



INDEKS INDEX	KOLOR COLOR
110-1002	● czarny black
110-1004	● niebieski blue

EAN BARCODE





**EAGLE**

### Dziurkacz P7123

- dziurkacz metalowy o dużej wytrzymałości
- pojemnik na odpady z tworzywa sztucznego nierysującego podłoża
- podwójny wskaźnik środka strony
- listwa formatowa
- blokada do łatwego przechowywania

### Punch P7123

- heavy duty metal punch
- waste container made of non-abrasive material
- double page center indicator
- guide bar
- lever lock for easy storage

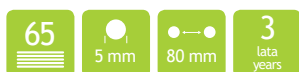

INDEKS INDEX

EAN BARCODE

110-1700

**EAGLE**

### Dziurkacz TY845R

- metalowa konstrukcja
- pojemnik na odpady z tworzywa sztucznego nierysującego podłoża
- plastikowa listwa formatowa

### Punch TY845R

- metal construction
- waste container made of non-abrasive material
- plastic guide bar

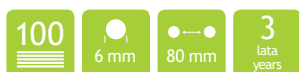

INDEKS INDEX

EAN BARCODE

110-1400



## Dziurkacz BIN 04029

- dziurkacz metalowy o dużej wytrzymałości
- antypoślizgowe elementy w podstawie
- listwa formatowa
- wskaźnik środka strony
- przezroczysty, wysuwany pojemnik na ścinki
- wymiary: 340x145x263 mm
- regulacja odstępu dziurek od krawędzi kartki: 9–20 mm
- zapasowe podkładki pod bolce
- waga 6,7 kg

## Punch BIN 04029

- heavy duty metal punch
- non-slip elements in base
- guide bar
- page center indicator
- transparent, sliding waste box
- dimensions: 340x145x263 mm
- adjustable hole distance from sheet edge: 9–20 mm
- spare pads for punching cotter-pin included
- weight 6,7 kg



INDEKS INDEX

EAN BARCODE

110-1413

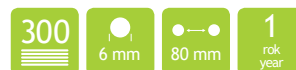

## Zestaw J5072BC

### DZIURKACZ P6068B

- dziurkacz metalowy
- pojemnik na odpady z tworzywa sztucznego nierysującego podłoża
- listwa formatowa
- wskaźnik środka strony

### ZSZYWACZ S5072

- wskaźnik ilości zszywek
- + zszywki 26/6 – 200 szt.

## Set J5072BC

### PUNCH P6068B

- metal construction
- waste container made of non-abrasive material
- guide bar
- page center indicator

### STAPLER S5072

- wskaźnik ilości zszywek
- + staples 26/6 – 200 pcs.

**EAGLE**



INDEKS INDEX

EAN BARCODE

110-1699



## Zszywacze na zszywki #10

- metalowa konstrukcja
- obudowa z trwałego tworzywa

## Staplers for #10 staples

- metal construction
- casing made of durable material

### 1011A

- wbudowany wyciągacz zszywek
- wskaźnik ilości zszywek

#### 1011A

- integrated staple remover
- staples residue indicator



INDEKS INDEX	KOLOR COLOR	EAN BARCODE
110-1147	● czarny black	5 903364 202637
110-1148	● czerwony red	5 903364 202712
110-1149	● niebieski blue	5 903364 202651
110-1150	● szary grey	5 903364 202699

### 1001BDS

- wbudowany wyciągacz zszywek

#### 1001BDS

- integrated staple remover



INDEKS INDEX	KOLOR COLOR	EAN BARCODE
110-1142	● czarny black	5 903364 202538
110-1143	● czerwony red	5 903364 202613
110-1144	● niebieski blue	5 903364 202552

### 2001BD

- wbudowany wyciągacz zszywek
- wskaźnik ilości zszywek

#### 2001BD

- integrated staple remover
- staples residue indicator



INDEKS INDEX	KOLOR COLOR	EAN BARCODE
110-1156	● czarny black	5 903364 203030
110-1157	● czerwony red	5 903364 203115
110-1158	● niebieski blue	5 903364 203054
110-1155	● szary grey	5 903364 203092

### 5002

- wskaźnik ilości zszywek

#### 5002

- staples residue indicator



INDEKS INDEX	KOLOR COLOR	EAN BARCODE
110-1197	● czerwony red	5 903364 204136
110-1198	● niebieski blue	5 903364 204075
110-1195	● brązowy brown	5 903364 204099
110-1199	● fioletowy violet	5 903364 204112

## Zszywacz mini 868

- metalowa konstrukcja
- obudowa z trwałego tworzywa
- wbudowany wyciągacz zszywek
- wskaźnik ilości zszywek

### Stapler mini 868

- metal construction
- casing made of durable material
- integrated staple remover
- staples residue indicator



INDEKS INDEX	KOLOR COLOR	EAN BARCODE
110-1223	● czarny black	5 903364 204877
110-1224	● czerwony red	5 903364 204952
110-1225	● niebieski blue	5 903364 204891
110-1226	● szary grey	5 903364 204938

## Zszywacz 910B

- metalowa konstrukcja
- obudowa z trwałego tworzywa
- wskaźnik ilości zszywek

### Stapler 910B

- metal construction
- casing made of durable material
- staples residue indicator



INDEKS INDEX	KOLOR COLOR	EAN BARCODE
110-1242	● czarny black	5 903364 205379
110-1244	● niebieski blue	5 903364 205393

## Zszywacz 930B

- metalowa konstrukcja
- obudowa z trwałego tworzywa
- wskaźnik ilości zszywek

### Stapler 930B

- metal construction
- casing made of durable material
- staples residue indicator



INDEKS INDEX	KOLOR COLOR	EAN BARCODE
110-1248	● czarny black	5 903364 205577
110-1249	● czerwony red	5 903364 205652
110-1250	● niebieski blue	5 903364 205591

## Zszywacz S5072B

- metalowa konstrukcja
- transparentna obudowa z tworzywa
- wskaźnik ilości zszywek

### Stapler S5072B

- metal construction
- transparent casing made of durable material
- staples residue indicator



INDEKS INDEX	KOLOR COLOR	EAN BARCODE
110-1306	● czerwony red	5 903364 212049
110-1307	● niebieski blue	5 903364 212025
110-1304	● brązowy brown	5 903364 213527

## Zszywacz 204

- zszywacz metalowy
- wykończenie z tworzywa sztucznego
- podstawa nierysująca podłoża
- wskaźnik ilości zszywek

### Stapler 204

- metal stapler
- finishing elements made of durable material
- base made of non-abrasive material
- staples residue indicator



INDEKS INDEX	KOLOR COLOR	EAN BARCODE
110-1161	● czarny black	5 903364 203252
110-1162	● czerwony red	5 903364 203337
110-1163	● niebieski blue	5 903364 203276
110-1164	● szary grey	5 903364 203313

## Zszywacz 205

- zszywacz metalowy
- wykończenie z tworzywa sztucznego
- podstawa nierysująca podłoża
- wskaźnik ilości zszywek
- nowy mechanizm ładowania zszywek

### Stapler 205

- metal stapler,
- finishing elements made of durable material
- base made of non-abrasive material
- staples residue indicator
- new loading mechanism



INDEKS INDEX	KOLOR COLOR	EAN BARCODE
110-1166	● czarny black	5 903364 203351
110-1167	● czerwony red	5 903364 203436
110-1168	● niebieski blue	5 903364 203375
110-1169	● szary grey	5 903364 203412

## Zszywacz 208

- zszywacz metalowy
- wykończenie z tworzywa sztucznego
- podstawa nierysująca podłoża

### Stapler 208

- metal stapler
- finishing elements made of durable material
- base made of non-abrasive material



INDEKS INDEX	KOLOR COLOR	EAN BARCODE
110-1455	● czarny black	5 903364 214234
110-1456	● szary grey	5 903364 214258

## Zszywacz 4001BD

- metalowa konstrukcja
- obudowa z trwałego tworzywa
- wskaźnik ilości zszywek

### Stapler 4001BD

- metal construction
- casing made of durable material
- staples residue indicator



INDEKS INDEX	KOLOR COLOR	EAN BARCODE
110-1186	● czarny black	5 903364 203856
110-1188	● niebieski blue	5 903364 203870

## Zszywacz Omax S5131B

- metalowa konstrukcja
- obudowa z trwałego tworzywa
- wskaźnik ilości zszywek

INDEKS INDEX KOLOR COLOR

110-1429 ● czarno-szary black&grey

EAN BARCODE



## Stapler Omax S5131B

- metal construction
- casing made of durable material
- staples residue indicator



## Zszywacz Axa S6120B

- zszywacz metalowy
- wykończenie z tworzywa sztucznego
- podstawa nierysująca podłoża
- wskaźnik ilości zszywek



INDEKS INDEX KOLOR COLOR

110-1441 ● biało-pomarańczowy white&orange

110-1440 ● biało-niebieski white&blue

EAN BARCODE



## Stapler Axa S6120B

- metal stapler
- finishing elements made of durable material
- base made of non-abrasive material
- staples residue indicator



## Zszywacz 950L

- zszywacz metalowy długoramienny z wykończeniami z tworzyw sztucznych
- podstawa nierysująca podłoża
- skala w centymetrach i calach
- wskaźnik ilości zszywek
- zintegrowana listwa formatowa

INDEKS INDEX KOLOR COLOR

110-1265 ● czarny black

110-1267 ● niebieski blue

EAN BARCODE



## Stapler 950L

- long arm metal stapler with plastic elements
- base made of non-abrasive material
- cm and inch scale
- staples residue indicator
- integrated guide bar



### Zszywacz 414

- zszywacz metalowy
- wykończenie z tworzywa sztucznego
- antypoślizgowe elementy w podstawie
- obrotowe ramię
- wskaźnik ilości zszywek



INDEKS INDEX

110-1189

EAN BARCODE



### Stapler 414

- metal stapler
- finishing elements made of durable material
- non-slip elements in base
- swivel arm
- staples residue indicator



### Zszywacz 9628

- metalowa konstrukcja
- podstawa nierysująca podłoża
- obrotowe ramię z trwałego tworzywa
- wskaźnik ilości zszywek



INDEKS INDEX

110-1270

110-1272

KOLOR COLOR

● czarny black

● niebieski blue

EAN BARCODE



### Stapler 9628

- metal construction
- base made of non-abrasive material
- swivel arm made of durable material
- staples residue indicator



## Zszywacz nożycowy 828L

- zszywacz metalowy
- mechanizm nożycowy
- wskaźnik ilości zszywek

## Plier 828L

- metal plier
- staples residue indicator



### INDEKS INDEX KOLOR COLOR

- |          |             |       |
|----------|-------------|-------|
| 110-1221 | ● czarny    | black |
| 110-1632 | ● niebieski | blue  |

### EAN BARCODE



## Zszywacz Jet Stapler S10061B

- metalowa konstrukcja
- redukcja siły nacisku do 70%

## Jet Stapler S10061B

- metal construction
- force reduction up to 70%



### INDEKS INDEX KOLOR COLOR

- |          |                |            |
|----------|----------------|------------|
| 110-1640 | ● czarno-szary | black&grey |
| 110-1641 | ● szaro-czarny | grey&black |

### EAN BARCODE



## Zszywacz automatyczny EG-1610USB

- solidny mechanizm zapewnia doskonałą wydajność i cichą pracę
- zasilanie sieciowe (USB) lub bateryjne (nie dołączono)
- kabel USB w zestawie

## Automatic stapler EG-1610USB

- durable motorized mechanism provides excellent performance and quiet operation
- for AA batteries (not included) and USB cable
- USB cable included



USB

### INDEKS INDEX KOLOR COLOR

- |          |          |       |
|----------|----------|-------|
| 110-1701 | ● czarny | black |
|----------|----------|-------|

### EAN BARCODE





## Zszywacz TYSFT843

- metalowa konstrukcja
- wzmocniona podstawa zwiększa stabilność zszywania, nie rysuje podłoża
- antypoślizgowe ramię
- redukcja siły nacisku do 50%

### Stapler TYSFT843

- metal construction
- strengthened base provides stapling stability
- base made of non-abrasive material
- non-slip arm
- force reduction up to 50%



INDEKS INDEX KOLOR COLOR

110-1645      ○ biały white

EAN BARCODE



## Zszywacze 938 / 939

- zszywacze metalowe o dużej wytrzymałości
- stabilna podstawa nierysująca podłoża
- wskaźnik ilości zszywek

### Staplers 938 / 939

- heavy duty metal staplers
- stable base made of non-abrasive material
- staples residue indicator

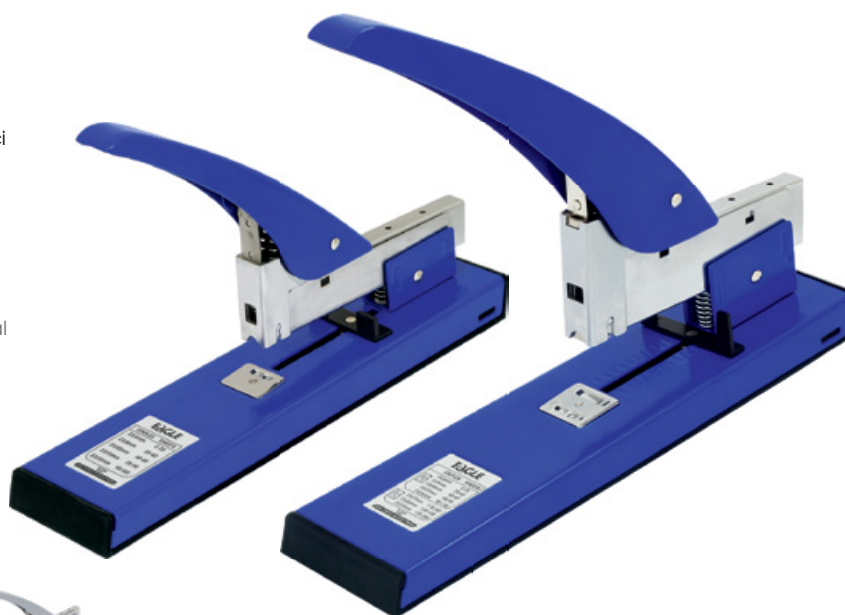

#### 938

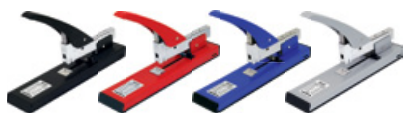

INDEKS INDEX KOLOR COLOR

110-1253      ● czarny black  
 110-1254      ● czerwony red  
 110-1255      ● niebieski blue  
 110-1256      ● szary grey

EAN BARCODE



#### 939



INDEKS INDEX KOLOR COLOR

110-1258      ● czarny black  
 110-1260      ● niebieski blue

EAN BARCODE

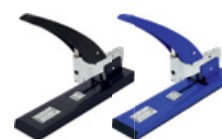

## Zszywacze 8538 / 8539

- zszywacze metalowe o dużej wytrzymałości
- stabilna podstawa nierysująca podłoża
- wskaźnik ilości zszywek
- antypoślizgowe ramię
- miejsce na opis



## Staplers 8538 / 8539

- heavy duty metal staplers
- stable base made of non-abrasive material
- staples residue indicator
- non-slip arm
- place for signature



### 8538

- dodatkowy pojemnik na zapasowe zszywki
- integrated spare staples container



INDEKS INDEX KOLOR COLOR

110-1401 ● grafitowy graphite

EAN BARCODE



### 8539



INDEKS INDEX KOLOR COLOR

110-1402 ● grafitowy graphite



EAN BARCODE



## Rozszywacz Alpha R5026B

- metalowa konstrukcja
- obudowa z trwałego tworzywa
- posiada blokadę

### Staple remover Alpha R5026B

- metal construction
- casing made of durable material
- locking mechanism

3 lata years



INDEKS INDEX	KOLOR COLOR	EAN BARCODE
110-1125	● czarny black	5 903364 208899
110-1126	● niebieski blue	5 903364 208912
110-1127	● szary grey	5 903364 209483



## Rozszywacz 1029

- metalowa konstrukcja
- obudowa z trwałego tworzywa
- uniwersalny

### Staple remover 1029

- metal construction
- casing made of durable material
- for all types of staples



3 lata years



INDEKS INDEX	KOLOR COLOR	EAN BARCODE
110-1118	● czarny black	5 903364 202330
110-1119	● czerwony red	5 903364 202415
110-1120	● niebieski blue	5 903364 202354
110-1121	● szary grey	5 903364 202392



## Zszywki

- standardowa jakość
- pakowane po 1000 szt.

### Staples

- standard quality
- box 1000 pcs.



INDEKS INDEX	ROZMIAR SIZE	EAN BOX BARCODE BOX	EAN BOX 10 BARCODE BOX 10
110-1389	#10	5 903364 230197	5 903364 230203
110-1388	#24/6	5 903364 230210	5 903364 230227
110-1390	#26/6	5 903364 246303	5 903364 246310

## Zszywki miedziane

- zszywki biurowe
- pakowane po 1000 szt.

### Copper staples

- office staples
- box 1000 pcs.



INDEKS INDEX	ROZMIAR SIZE	EAN BOX BARCODE BOX	EAN BOX 10 BARCODE BOX 10
110-1422	#24/6	5 903364 230616	5 903364 230623

## Zszywki kolorowe 24/6

- 1000 szt.

INDEKS INDEX	KOLOR COLOR	EAN BARCODE
* 110-1664	● czerwony red	5 903364 265960
* 110-1663	● niebieski blue	5 903364 265946
* 110-1662	● zielony green	5 903364 265922

\* do wyczerpania zapasów while stock lasts

## Color staples 24/6

- 1000 pcs.



## Zszywki

- galwanizowane zszywki biurowe
- ścięte zakończenia zapobiegają zaginaniu zszywek podczas przebijania pliku papieru
- opakowanie 1000 szt.

## Staples

- electroplated office staples
- chisel tips prevent from bending staples while cutting through paper
- box 1000 pcs.



INDEKS INDEX	ROZMIAR SIZE	EAN BARCODE
110-1319	#24/6	



## Zszywki specjalistyczne

- wysokiej jakości zszywki do zszywaczy specjalistycznych
- ilość zszywanych kartek podana dla papieru 80 g/m<sup>2</sup>

## Heavy duty staples

- high quality staples for heavy duty staplers
- stapling capacity for 80 gsm paper



### do zszywaczy:

for staplers:

**938, 8538, 939, 8539, Alpha S6030**

INDEKS INDEX	ZSZYWKĄ STAPLE	ZSZYWA KARTEK STAPLING CAPACITY	EAN BARCODE
110-1324	23/6	2-30	
110-1325	23/8	20-40	
110-1326	23/10	40-60	
110-1327	23/13	60-90	

### do zszywaczy:

for staplers:

**939, 8539**

INDEKS INDEX	ZSZYWKĄ STAPLE	ZSZYWA KARTEK STAPLING CAPACITY	EAN BARCODE
110-1328	23/15	90-110	
110-1329	23/17	110-130	
110-1330	23/20	130-170	
110-1331	23/23	170-200	

**Spinacze okrągłe**

- galwanizowane



INDEKS INDEX	SYMBOL SYMBOL	ROZMIAR SIZE	OPAK. BOX	EAN BOX BARCODE BOX	EAN BOX 10 BARCODE BOX 10
110-1658	R25	25 mm	100 szt. pcs.	5 903364 245092	5 903364 245108
110-1381	R28	28 mm	100 szt. pcs.	5 903364 230036	5 903364 230043
110-1382	R33	33 mm	100 szt. pcs.	5 903364 230050	5 903364 230067
110-1383	R50	50 mm	100 szt. pcs.	5 903364 230074	5 903364 230081
110-1384	R70	70 mm	50 szt. pcs.	5 903364 230456	5 903364 230463

**Paper clips round**

- electroplated



**Spinacze trójkątne**

- galwanizowane

INDEKS INDEX	SYMBOL SYMBOL	ROZMIAR SIZE	OPAK. BOX	EAN BOX BARCODE BOX	EAN BOX 10 BARCODE BOX 10
110-1385	T25	25 mm	100 szt. pcs.	5 903364 230098	5 903364 230104
110-1386	T28	28 mm	100 szt. pcs.	5 903364 230111	5 903364 230128
110-1387	T31	31 mm	100 szt. pcs.	5 903364 230135	5 903364 230142

**Paper clips triangular**

- electroplated



**Spinacze kolorowe**

- metalowe
- powlekane kolorowym PCV
- miks kolorów w pudełku

INDEKS INDEX	ROZMIAR SIZE	OPAK. BOX	EAN BARCODE
110-1661	50 mm	50 szt. pcs.	5 903364 265915

**Paper clips color**

- metal
- coated with color PVC
- color mix

**Spinacze krzyżowe**

- galwanizowane
- duże spinacze plikowe



INDEKS INDEX	SYMBOL SYMBOL	ROZMIAR SIZE	OPAK. BOX	EAN BARCODE
110-1138	Nr 1	70 mm	12 szt. pcs.	5 903364 244156
110-1137	Nr 2	41 mm	50 szt. pcs.	5 903364 244132

**Butterfly paper clips**

- electroplated
- large file clips

## Pinezki srebrne

- galwanizowane

INDEKS INDEX	SYMBOL SYMBOL	OPAK. BOX		EAN BOX BARCODE BOX
110-1378	S50	50 szt. pcs.		
110-1391	S100	100 szt. pcs.		

## Thumb tacks silver

- electroplated

EAN BOX 10 BARCODE BOX 10



## Pinezki złote

- galwanizowane

INDEKS INDEX	SYMBOL SYMBOL	OPAK. BOX		EAN BOX BARCODE BOX
110-1377	G50	50 szt. pcs.		

EAN BOX 10 BARCODE BOX 10



## Thumb tacks golden

- electroplated

## Pinezki tablicowe kolorowe

- do tablic korkowych

INDEKS INDEX	OPAK. BOX		EAN BARCODE
110-1657	50 szt. pcs.		
110-1655	100 szt. pcs.		

## Thumb tacks color

- for cork boards



## Szpilki

- galwanizowane

INDEKS INDEX	ROZMIAR SIZE	OPAK. BOX		EAN BOX BARCODE BOX
110-1588	15 mm	50 g		
110-1380	28 mm	50 g		

EAN BOX 10 BARCODE BOX 10



## Office pins

- electroplated

## Klipy

- sprężyste, o wysokiej trwałości
- lakierowana na czarno powłoka odporna na zadrapania

INDEKS INDEX	ROZMIAR SIZE	OPAK. BOX		EAN BARCODE
110-1091	15 mm	12 szt. pcs.		
110-1092	19 mm	12 szt. pcs.		
110-1093	25 mm	12 szt. pcs.		
110-1094	32 mm	12 szt. pcs.		
110-1095	41 mm	12 szt. pcs.		
110-1096	51 mm	12 szt. pcs.		

## Binder clips

- durable, resilient
- black, scratch-resistant painted coating



## Opakowania plastikowe

• opakowania z polistyrenu

## Plastic boxes

• made of polystyrene

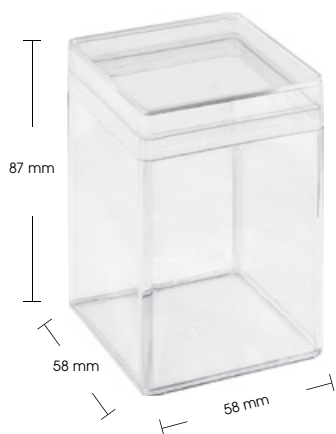

**6H**



**T4**



**MAG**

• magnetyczne  
• magnetic

## Klipy kolorowe

- sprężyste, o wysokiej trwałości
- powłoka lakierowana, kolorowa, odporna na zadrapania

## Binder clips color

- durable, resilient
- color, scratch-resistant painted coating



INDEKS INDEX	ROZMIAR SIZE	OPAK. BOX	OPAK. BOX	EAN BARCODE
110-1637	19 mm	24 szt. pcs.	6H	5 903364 265076

## Gumki recepturki

- elastyczne gumki
- miks kolorów w pudełku

## Rubber bands

- elastic



INDEKS INDEX	ROZMIAR SIZE	OPAK. BOX	OPAK. BOX	EAN BARCODE
130-1715	57 mm	25 g	T4	5 903364 265052

## Pojemnik na spinacze TY-15P

- plastikowy, magnetyczny
- zawiera spinacze kolorowe powlekane

## Paper-clip holder TY-15P

- made of durable material
- magnetic
- paper-clips included



INDEKS INDEX	KOLOR COLOR	OPAK. BOX	EAN BARCODE
120-1048	● czarny black	MAG	5 903364 207137
120-1048	● niebieski blue	MAG	5 903364 212940

## Spinacze

- galwanizowane
- 80 sztuk w pojemniku magnetycznym

## Paper clips

- electroplated
- 80 pcs. in magnetic dispenser



INDEKS INDEX	ROZMIAR SIZE	OPAK. BOX	EAN BARCODE
★ 110-1665	28 mm	80 szt. pcs.	5 903364 276027

★ do wyczerpania zapasów while stock lasts

## Spinacze złote

- galwanizowane

## Paper clips golden

- electroplated

Grand®

INDEKS INDEX	ROZMIAR SIZE	OPAK. BOX	OPAK. BOX	EAN BARCODE
110-1633	28 mm	100 szt. pcs.	T4	





## Spinacze kolorowe

- metalowe, powlekane kolorowym PCV

## Paper clips color

- metal, coated with color PVC



INDEKS INDEX	ROZMIAR SIZE	OPAK. BOX	OPAK. BOX	EAN BARCODE
110-1139	28 mm	100 szt. pcs.	T4	
110-1660	50 mm	18 szt. pcs.	T4	

## Spinacze zebra

- powlekane

## Paper clips zebra

- coated



INDEKS INDEX	ROZMIAR SIZE	OPAK. BOX	OPAK. BOX	EAN BARCODE
110-1634	28 mm	80 szt. pcs.	T4	

## Spinacze groszki

- metalowe, lakierowane

## Paper clips green pea

- metal, varnished



INDEKS INDEX	ROZMIAR SIZE	OPAK. BOX	OPAK. BOX	EAN BARCODE
110-1702	30 mm	20 szt. pcs.	T4	

## Spinacze marchewka

- metalowe, lakierowane

## Paper clips carrot

- metal, varnished



INDEKS INDEX	ROZMIAR SIZE	OPAK. BOX	OPAK. BOX	EAN BARCODE
110-1703	37 mm	20 szt. pcs.	T4	



## Pinezki srebrne

- galwanizowane

### Thumb tacks silver

- electroplated



INDEKS INDEX	OPAK. BOX	OPAK. BOX	EAN BARCODE
110-1636	50 szt. pcs.	T4	

## Pinezki kolorowe

- galwanizowane, pokryte lakierem

### Thumb tacks color

- electroplated, painted



INDEKS INDEX	OPAK. BOX	OPAK. BOX	EAN BARCODE
110-1115	50 szt. pcs.	T4	

## Pinezki tapicerskie

- długość 15 mm

INDEKS INDEX	KOLOR COLOR	OPAK. BOX	OPAK. BOX	EAN BARCODE
110-1483	● srebrne silver	50 szt. pcs.	T4	
110-1482	● złote golden	50 szt. pcs.	T4	

### Thumb tacks long

- 15 mm long



## Pinezki „flagi”

- kolorowe
- do tablic korkowych

### Thumb tacks flags

- color
- for cork boards

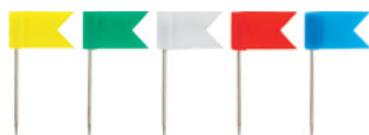

INDEKS INDEX	OPAK. BOX	OPAK. BOX	EAN BARCODE
110-1001	25 szt. pcs.	T4	

## Pinezki tablicowe kolorowe

- kolorowe
- do tablic korkowych

### Thumb tacks for cork boards

- color



INDEKS INDEX	OPAK. BOX	OPAK. BOX	EAN BARCODE
110-1419	30 szt. pcs.	T4	
110-1116	50 szt. pcs.	T4	
★ 110-1656	100 szt. pcs.	T4	

★ do wyczerpania zapasów while stock lasts

## Szpilki

- uniwersalne
- galwanizowane

## Office pins

- electroplated

INDEKS INDEX	ROZMIAR SIZE	OPAK. BOX	OPAK. BOX
110-1638	28 mm	50 g	T4



## Szpilki kolorowe

- szpilki z kolorowymi główkami
- miks kolorów w pudełku

## Office pins color

- color mix

### 3,8 mm x 15 mm

INDEKS INDEX	OPAK. BOX	OPAK. BOX
110-1671	100 szt. pcs.	T4



### 3,8 mm x 33 mm

INDEKS INDEX	OPAK. BOX	OPAK. BOX
110-1670	100 szt. pcs.	T4



### 6 mm x 11 mm

INDEKS INDEX	OPAK. BOX	OPAK. BOX
110-1672	100 szt. pcs.	T4



## Magnesy

- w plastikowej obudowie
- średnica: 20, 30, 40 mm

## Magnets

- casing made of durable material
- diameter: 20, 30, 40 mm



GR-620



GR-6020

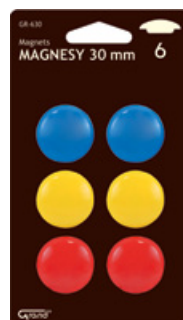

GR-630



GR-530S

### 20 mm

INDEKS INDEX	SYMBOL SYMBOL	OPAK. BOX	EAN BARCODE
130-1549	GR-620	6 szt. pcs.	5 903364 258805
130-1551	GR-6020	60 szt. pcs.	5 903364 258108

### 30 mm

INDEKS INDEX	SYMBOL SYMBOL	OPAK. BOX	EAN BARCODE
130-1550	GR-630	6 szt. pcs.	5 903364 258092
130-1814	GR-530S	5 szt. pcs.	5 903364 276416

### Dostępne kolory:

Available colors:



### 20 mm

- opak. 10 szt.
- box 10 pcs.



### 30 mm

- opak. 10 szt.
- box 10 pcs.



### 40 mm

- opak. 10 szt.
- box 10 pcs.



INDEKS INDEX	KOLOR COLOR	EAN BARCODE
130-1689	○ biały white	5 903364 258665
130-1687	● czarny black	5 903364 258658
130-1688	● czerwony red	5 903364 258610
130-1690	● niebieski blue	5 903364 258634
130-1692	● zielony green	5 903364 258641
130-1691	● żółty yellow	5 903364 258627

INDEKS INDEX	KOLOR COLOR	EAN BARCODE
130-1693	○ biały white	5 903364 258726
130-1694	● czarny black	5 903364 258719
130-1695	● czerwony red	5 903364 258672
130-1696	● niebieski blue	5 903364 258696
130-1697	● zielony green	5 903364 258702
130-1698	● żółty yellow	5 903364 258689

INDEKS INDEX	KOLOR COLOR	EAN BARCODE
130-1699	○ biały white	5 903364 258788
130-1700	● czarny black	5 903364 258771
130-1701	● czerwony red	5 903364 258733
130-1702	● niebieski blue	5 903364 258757
130-1703	● zielony green	5 903364 258764
130-1704	● żółty yellow	5 903364 258740

## Magnesy

- opakowanie: woreczek z zawieszka



## Magnets

- packed in plastic bags

INDEKS INDEX	ROZMIAR SIZE	OPAK. BOX	EAN BARCODE
130-1787	20 mm x 4 mm	12 szt. pcs.	5 903364 265847
130-1788	30 mm x 5 mm	12 szt. pcs.	5 903364 265854

## Magnesy kolorowe

- 4 kol.: żółty, granatowy, czerwony, zielony



## Color magnets

- 4 colors: yellow, navy blue, red, green

INDEKS INDEX	ROZMIAR SIZE	OPAK. BOX	EAN BARCODE
130-1890	15 mm	40 szt. pcs.	8 595083 572657
130-1891	25 mm	20 szt. pcs.	8 595083 572671

**office organizing**  
**organizacja dokumentów**

## Koperty zatraskowe

• materiał: polipropylen



## Side load envelopes

• materiał: polypropylene

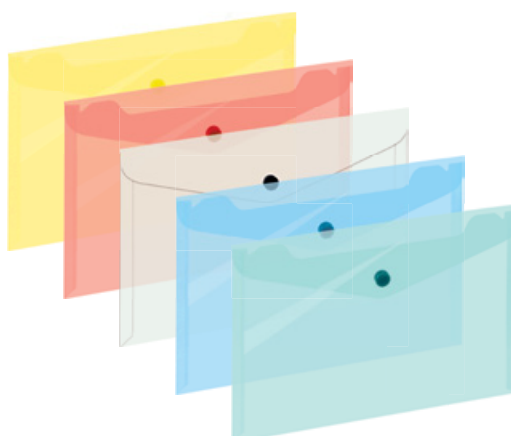

### Koperta 9113

Envelope 9113

A4 PP

INDEKS INDEX	KOLOR COLOR	EAN BARCODE
120-1446	○ biały white	5 903364 216641
120-1447	● czerwony red	5 903364 216627
120-1448	● niebieski blue	5 903364 216580

### Koperta ZP043

Envelope ZP043

A5 PP

INDEKS INDEX	KOLOR COLOR	EAN BARCODE
120-1441	○ biały white	5 903364 216689
120-1442	● czerwony red	5 903364 216726
120-1443	● niebieski blue	5 903364 216702



### Koperta 9113

Envelope 9113

A4 PP

INDEKS INDEX	KOLOR COLOR	EAN BARCODE
120-1207	○ biały white	5 903364 211073
120-1166	● żółty yellow	5 903364 211097
120-1163	● czerwony red	5 903364 211059
120-1164	● niebieski blue	5 903364 211011
120-1165	● zielony green	5 903364 211035

### Koperta ZP043

Envelope ZP043

A5 PP

INDEKS INDEX	KOLOR COLOR	EAN BARCODE
120-1251	○ biały white	5 903364 205553
120-1252	● żółty yellow	5 903364 206864
120-1253	● czerwony red	5 903364 206468
120-1254	● niebieski blue	5 903364 205874
120-1255	● zielony green	5 903364 206840

## Koperta ZP042

• rozmiar: 254x130 mm (do formatu DL)

## Envelope ZP042

• dimensions: 254x130 mm (for DL format)



INDEKS INDEX	KOLOR COLOR
120-1478	○ biały white
120-1481	● żółty yellow
120-1479	● czerwony red
120-1477	● niebieski blue
120-1480	● zielony green

### EAN BARCODE

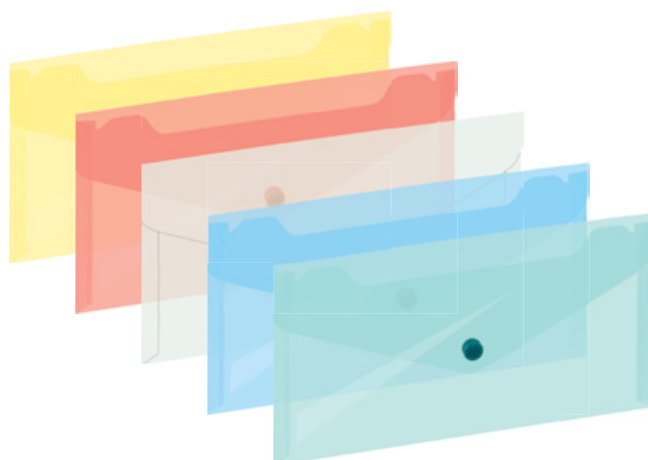

## Koperta ZP046-DL

• rozmiar: 225x124 mm (do formatu DL)

## Envelope ZP046-DL

• dimensions: 225x124 mm (for DL format)



INDEKS INDEX	KOLOR COLOR
120-1868	○ biały white
120-1869	● żółty yellow
120-1867	● czerwony red
120-1870	● niebieski blue
120-1871	● zielony green

### EAN BARCODE



## Koperta z europerforacją ZP045A

• materiał: polipropylen  
• posiada europerforację

## Insert pocket ZP045A

• materiał: polipropylen  
• equipped with universal side holes



INDEKS INDEX	KOLOR COLOR
120-1461	○ biały white
120-1161	● niebieski blue
120-1162	● pomarańczowy orange

### EAN BARCODE



## Koperty z zamkiem strunowym

- materiał: polipropylen
- zewnętrzna kieszeń na wizytówkę
- zamek strunowy w różnych kolorach



## Clear storage envelopes

- material: polypropylene
- business card pocket
- color zip fastener



### Koperta EC009 B

Envelope EC009 B



INDEKS INDEX	KOLOR COLOR	EAN BARCODE
120-1055	○ biały white	5 903364 211479
120-1463	● żółty yellow	5 903364 211493
120-1462	● czerwony red	5 903364 211455
120-1464	● niebieski blue	5 903364 211417
120-1465	● zielony green	5 903364 211431

### Koperta EC007 B

Envelope EC007 B



INDEKS INDEX	KOLOR COLOR	EAN BARCODE
120-1174	○ biały white	5 903364 211370
120-1471	● żółty yellow	5 903364 211394
120-1470	● czerwony red	5 903364 211356
120-1472	● niebieski blue	5 903364 211318
120-1473	● zielony green	5 903364 211332



### Koperta EC011 B

- regulowana grubość grzbietu, maks. 30 mm



INDEKS INDEX	KOLOR COLOR	EAN BARCODE
120-1788	● żółty yellow	5 903364 217143
120-1787	● czerwony red	5 903364 217136
120-1789	● niebieski blue	5 903364 217150
120-1790	● zielony green	5 903364 217167

### Envelope EC011 B

- expandable: max 30 mm thick



## Koperta GR-P053

- kolorowy polipropylen
- zamek strunowy w kolorze białym
- rozmiar: 240x118 mm

DL PP

INDEKS INDEX KOLOR COLOR

120-1863	○ biały white
120-1864	● żółty yellow
120-1862	● czerwony red
120-1865	● niebieski blue
120-1866	● zielony green

EAN BARCODE



## Envelope GR-P053

- colorful polypropylene
- white zip fastener
- dimensions: 240x118 mm

Grand®



## Koperta ZP041 z gumką

- materiał: polipropylen
- zamykana na gumkę

A4 PP

INDEKS INDEX KOLOR COLOR

120-1853	○ biały white
120-1228	● żółty yellow
120-1225	● czerwony red
120-1226	● niebieski blue
120-1854	● zielony green

EAN BARCODE



## Document case ZP041

- materiał: polipropylen
- double elastic closure

Grand®



## Folia do laminacji

- do zastosowania w technice laminacji
- do wszelkiego typu dokumentów oraz zdjęć
- laminowanie chroni dokumenty przed zabrudzeniem, uszkodzeniem oraz zalaniem
- błyszcząca
- 100 szt.

80 mic 100

INDEKS INDEX DO FORMATU FOR SIZE

160-2192	A4 (216x303 mm)
160-2276	A3 (303x426 mm)

EAN BARCODE



## Laminating pouch

- for hot lamination technique
- for all types of documents and photos
- laminating protects documents from dirt, moisture or other damages
- glossy
- 100 pouches

Grand®







### Skoroszyt zaciskowy 9111

- materiał: polipropylen
- pojemność 40 arkuszy

### Clear portfolio 9111

- materiał: polypropylene
- capacity 40 sheets



A4 PP

INDEKS INDEX	KOLOR COLOR	EAN BARCODE
120-1239	○ biały white	5 903364 210977
120-1243	● żółty yellow	5 903364 210991
120-1242	● czerwony red	5 903364 210953
120-1240	● niebieski blue	5 903364 210915
120-1241	● zielony green	5 903364 210939



### Skoroszyt z klipem GR-505K

- materiał: polipropylen
- pojemność 35 arkuszy

### Clip report folder GR-505K

- materiał: polypropylene
- capacity 35 sheets



A4 PP

INDEKS INDEX	KOLOR COLOR	EAN BARCODE
120-1792	● czarny black	5 903364 217105
120-1791	● czerwony red	5 903364 217099
120-1793	● niebieski blue	5 903364 217112
120-1794	● szary grey	5 903364 217129

## Skoroszyty

- metalowe wąsy do wpinania dokumentów
- przednia okładka przezroczysta, tylna kolorowa
- wymienna listwa opisowa
- zaokrąglone rogi
- wyprodukowano w Polsce

## Report files

- metal fastener for punched papers
- front cover transparent, back cover colored
- removable description tag
- rounded corners
- made in Poland

Grand®

### GR-505

INDEKS INDEX KOLOR COLOR

- ★ 120-1763 ○ biały white
- ★ 120-1764 ● czarny black
- ★ 120-1765 ● czerwony red
- ★ 120-1766 ● niebieski blue
- ★ 120-1767 ● zielony green
- ★ do wyczerpania zapasów while stock lasts



EAN BARCODE



### GR-505E

- grzbiet z europerforacją: pasuje do każdego segregatora
- equipped with universal side holes

INDEKS INDEX KOLOR COLOR

- ★ 120-1758 ○ biały white
- ★ 120-1761 ● czarny black
- ★ 120-1762 ● czerwony red
- ★ 120-1759 ● niebieski blue
- ★ 120-1760 ● zielony green
- ★ do wyczerpania zapasów while stock lasts



EAN BARCODE



## Skoroszyt ofertowy

- grzbiet z europerforacją
- wewnętrzne przezroczyste kieszenie A4
- przednia okładka przezroczysta, tylna kolorowa
- wymienna listwa opisowa
- zaokrąglone rogi

### Clear book

- equipped with universal side holes
- transparent A4 pockets inside
- front cover transparent, back cover colored
- removable description tag
- rounded corners



SYMBOL SYMBOL KOSZULEK POCKETS

● czarny black

● czerwony red

● niebieski blue

● zielony green

★ GR-5010

10



★ GR-5020

20



- ★ do wyczerpania zapasów while stock lasts



Grand®

## Teczka ofertowa

- materiał: polipropylen
- wewnętrzne, przezroczyste kieszenie A4
- zewnętrzna etykieta opisowa

## Display book

- materiał: polypropylene
- transparent A4 pockets inside
- descriptive tag

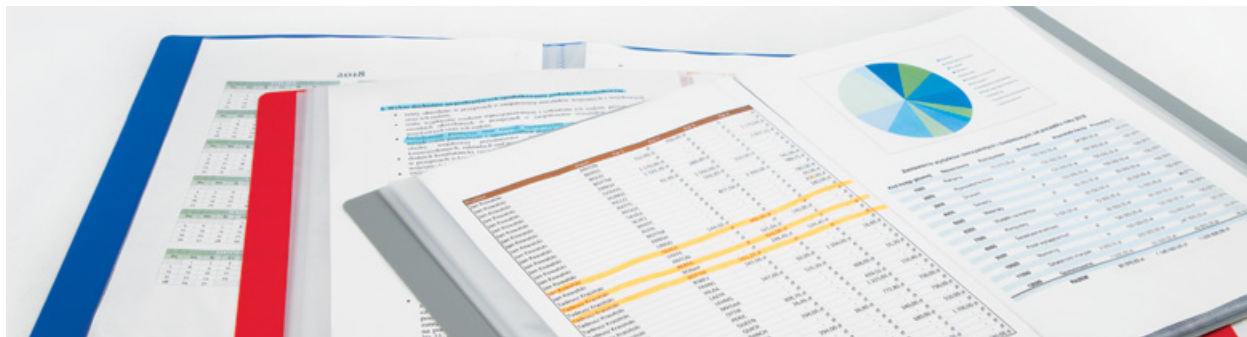

SYMBOL	SYMBOL	KOSZULEK POCKETS	● czarny black	● czerwony red	● niebieski blue	● szary grey	● zielony green
9001A	10	120-1190 	120-1191 	120-1192 	120-1818 	120-1817 	
9002A	20	120-1208 	120-1193 	120-1194 	120-1820 	120-1819 	
9003A	30	120-1195 	120-1209 	120-1196 	120-1822 	120-1821 	
9004A	40	120-1197 	120-1198 	120-1199 	120-1823 	120-1824 	
9006A	60	120-1200 	120-1210 	120-1201 	120-1826 	120-1825 	
9008A	80	120-1202 	120-1211 	120-1203 	120-1828 	120-1827 	
9010A	100	120-1204 	120-1205 	120-1206 	120-1830 	120-1829 	

## Teczka harmonijkowa 9112C

- materiał: polipropylen
- 12 przegródek
- przekładki indeksujące
- okienka opisowe
- 2 kieszonki na wizytówki
- zamykana na gumkę

## Expanding wallet 9112C

- material: polypropylene
- 12 dividers
- clear tab dividers
- changeable indexes
- 2 business card pockets
- elastic closure

**EAGLE**



A4

INDEKS INDEX	KOLOR COLOR
120-1156	● czarny black
120-1158	● niebieski blue

EAN BARCODE



## Aktówka harmonijkowa 9112A

- materiał: polipropylen
- 12 przegródek
- przekładki indeksujące
- okienka opisowe
- 2 kieszonki na wizytówki
- zamykana na klamrę
- rączka na grzbiecie

## Expanding briefcase 9112A

- material: polypropylene
- 12 dividers
- clear tab dividers
- changeable indexes
- 2 business card pockets
- buckle closure
- comfortable handle

**EAGLE**



A4

INDEKS INDEX	KOLOR COLOR
120-1219	● czarny black
120-1220	● czerwony red
120-1221	● niebieski blue

EAN BARCODE



## Przekładki do segregatora

- kartonowe
- możliwość wpięcia pionowo lub poziomo
- rozmiar 240x105 mm
- 4 kolory pastelowe lub 5 kolorów intensywnych
- pakiet 100 szt.

## Binder dividers

- cardboard
- use in vertical or horizontal position
- size 240x105 mm
- 5 intense or 4 pastel colors
- set 100 pcs.

**Grand**

100

INDEKS INDEX	KOLOR COLOR
120-1942	pastelowe pastel
120-1943	intensywne intense

EAN BARCODE

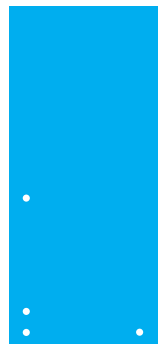

## Deska z klipem GR-991P

- z trwałego materiału
- zaokrąglone rogi
- wyposażona w sprężysty mechanizm zaciskowy służący do przytrzymania papieru
- jest doskonałą podkładką do pisania



## Clipboard GR-991P

- durable material
- rounded edges
- resilient mechanism for holding paper
- perfect as a writing pad

A4

INDEKS INDEX KOLOR COLOR

120-1848 ○ biały white

EAN BARCODE



## Teczki z klipem NOTOdesk

- z trwałego materiału zewnętrznie tłoczonego w prążki
- sprężysty mechanizm zaciskowy do przytrzymania papieru
- zaokrąglone rogi

## Clipboards with cover NOTOdesk

- durable material, outer surface ribbed
- resilient mechanism for holding paper
- rounded edges

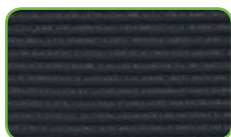

GR-2202

- klip u góry
- rozmiar: 320x240x14 mm

GR-2202

- top clip
- size: 320x240x14 mm

A4

INDEKS INDEX KOLOR COLOR

120-1876 ● czarny black

120-1877 ● czerwony red

EAN BARCODE



GR-2205

- klip z boku
- rozmiar: 325x242x12 mm

GR-2205

- side clip
- size: 325x242x12 mm

A4

INDEKS INDEX KOLOR COLOR

★ 120-1878 ● czarny black

120-1879 ● czerwony red



EAN BARCODE



★ do wyczerpania zapasów while stock lasts

## Szuflada na dokumenty 350

- wykonana z wysokiej jakości tworzywa
- możliwość łączenia skośnie w trzech różnych ustawieniach głębokości
- oszczędność miejsca – możliwość składania nieużywanych szuflad jedna w drugą
- specjalnie wyprofilowany i wycięty przód ułatwia wkładanie i wyjmowanie dokumentów

INDEKS INDEX	KOLOR COLOR	EAN BARCODE
120-1434	○ dymna smoky	
120-1433	○ transparentna transparent	

## Document tray 350



- made of high quality material
- possible to join slantwise in three different depth arrangements
- convenient storage – trays can be placed one into the other
- profiled front facilitates documents` operations



A4

## Przybornik płaski YL-T08

- przybornik płaski wykonany z wysokiej jakości tworzywa
- posiada 8 przegródek
- wymiary: 355x228x25 mm

INDEKS INDEX	KOLOR COLOR	EAN BARCODE
★ 120-1851	● czarna black	
★ 120-1852	○ dymna smoky	

★ do wyczerpania zapasów while stock lasts



## Stationery organizer YL-T08

- stationery organizer made of high quality material
- 8 compartments
- size: 355x228x25 mm



## Pojemnik na dokumenty F5093B

- z transparentnego tworzywa sztucznego
- na czasopisma, katalogi do formatu A4
- wymiary: 245x85x290 mm

INDEKS INDEX	KOLOR COLOR	EAN BARCODE
120-1046	● czerwony red	
120-1212	● niebieski blue	

## Document holder F5093B

- made of transparent material
- for magazines, catalogues of A4 format
- dimensions: 245x85x290 mm





A4



## Pojemnik na długopisy Ha! TYP691

- wykonany z tworzywa
- rozmiar: 80 x 80 x 98 mm



INDEKS INDEX	KOLOR COLOR	EAN BARCODE
120-1930	● niebieski blue	
120-1931	● różowy pink	
120-1932	● żółty yellow	

## Pen holder Ha! TYP691

- made of durable material
- size: 80x80x98 mm



Ha!

uchwyt do taśmy – s. 75  
tape dispenser – see p. 75

Ha!

dziurkacz, zszywacz – s. 6  
punch, stapler – see p. 6

**Kolekcja VIP**

• lakierowany metal w kolorze czarnym lub srebrnym

VIP collection

• black or silver lacquered metal

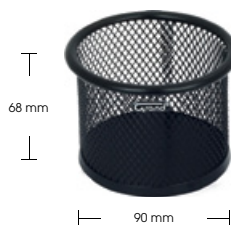
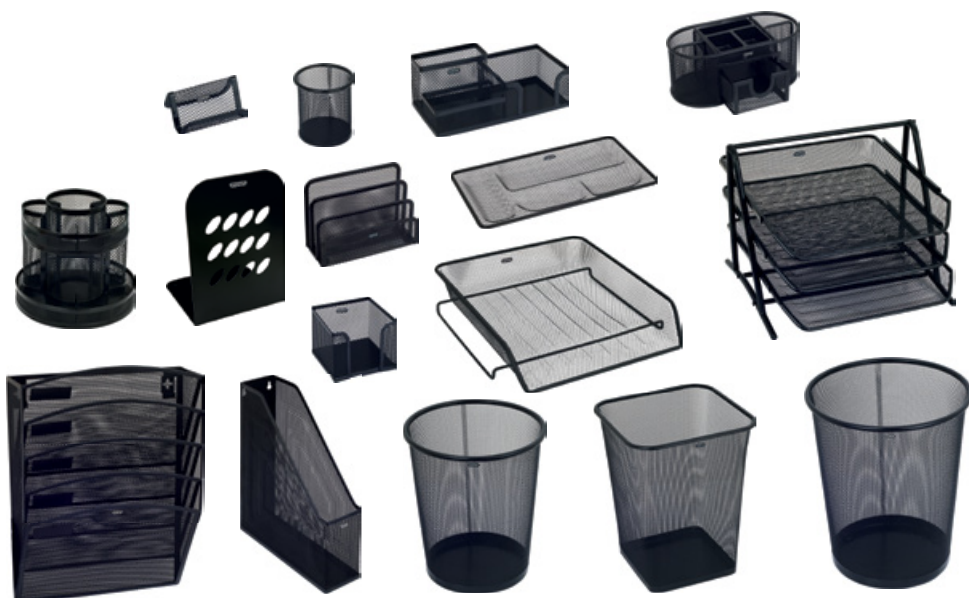

**Pojemnik na spinacze**  
GR-010 / GR-010S

Clip holder  
GR-010 / GR-010S

INDEKS INDEX	KOLOR COLOR
120-1119	● czarny black
120-1120	○ srebrny silver

EAN BARCODE

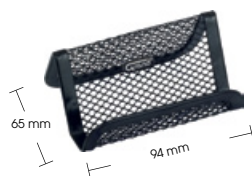

**Stojak na wizytówki**  
GR-340 / GR-340S

Name card holder  
GR-340 / GR-340S

INDEKS INDEX	KOLOR COLOR
120-1131	● czarny black
120-1132	○ srebrny silver

EAN BARCODE

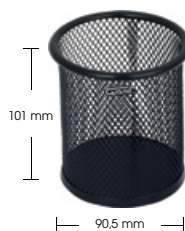

**Pojemnik na długopisy**  
GR-004 / GR-004S

Pen holder  
GR-004 / GR-004S

INDEKS INDEX	KOLOR COLOR
120-1125	● czarny black
120-1126	○ srebrny silver

EAN BARCODE



## Pojemnik na kartki GR-043 / GR-043S

INDEKS INDEX	KOLOR COLOR
120-1129	● czarny black
120-1130	○ srebrny silver

## Memo holder GR-043 / GR-043S

EAN BARCODE

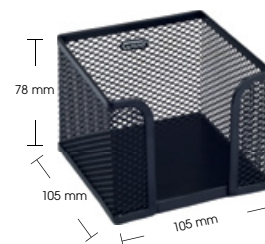

## Przybornik obrotowy GR-254

INDEKS INDEX	KOLOR COLOR
120-1782	● czarny black

## Rotary desk organizer GR-254

EAN BARCODE



## Przybornik na biurko GR-1776

INDEKS INDEX	KOLOR COLOR
120-1486	● czarny black

## Stationery holder GR-1776

EAN BARCODE

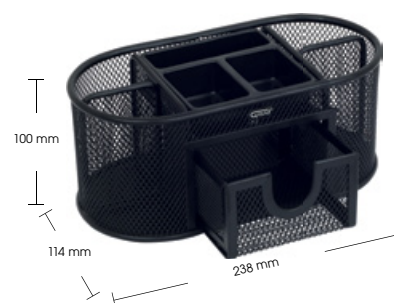

## Przybornik GR-093 / GR-093S

INDEKS INDEX	KOLOR COLOR
120-1334	● czarny black
120-1335	○ srebrny silver

## Stationery holder GR-093 / GR-093S

EAN BARCODE

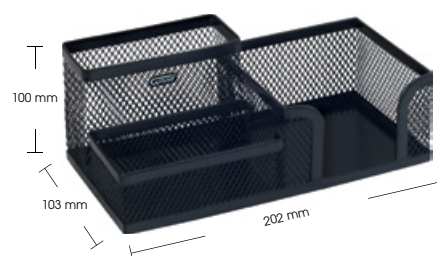

## Przybornik płaski GR-095 / GR-095S

INDEKS INDEX	KOLOR COLOR
120-1134	● czarny black
120-1136	○ srebrny silver

## Flat stationery holder GR-095 / GR-095S

EAN BARCODE

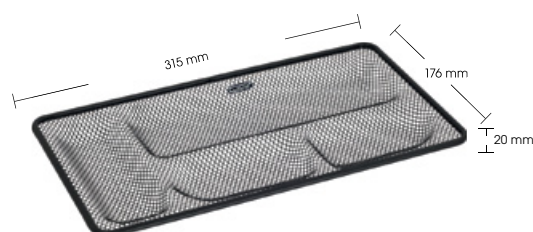



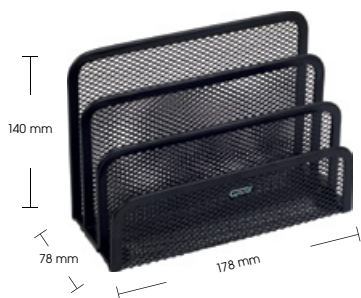

Stojak na koperty  
GR-034 / GR-034S

Envelope holder  
GR-034 / GR-034S

INDEKS INDEX	KOLOR COLOR
120-1121	● czarny black
120-1122	○ srebrny silver

EAN BARCODE

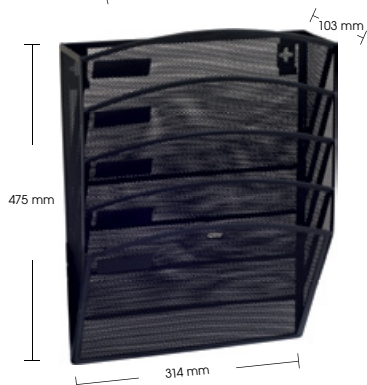

Naścienny pojemnik  
na dokumenty  
GR-080 / GR-080S

Wall file holder  
GR-080 / GR-080S

INDEKS INDEX	KOLOR COLOR
120-1487	● czarny black
120-1783	○ srebrny silver

EAN BARCODE

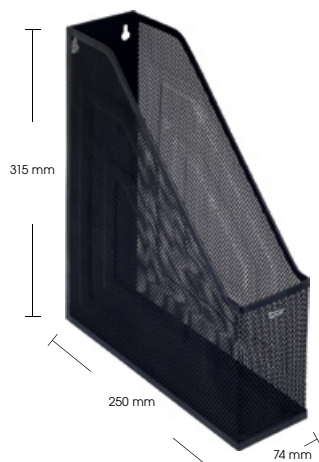

Pojemnik na prasę  
GR-053 / GR-053S

Magazine holder  
GR-053 / GR-053S

INDEKS INDEX	KOLOR COLOR
120-1123	● czarny black
120-1124	○ srebrny silver

EAN BARCODE

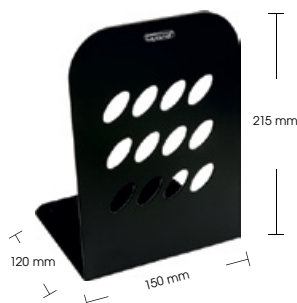

Podstawki do książek  
GR-048

Bookends GR-048

- metalowe
- w zestawie 2 szt.

- metal
- set 2 pcs.

INDEKS INDEX	KOLOR COLOR
120-1723	● czarny black

EAN BARCODE



Podstawki do książek  
9354

Bookends 9354

- metalowe
- w zestawie 2 szt.

- metal
- set 2 pcs.

INDEKS INDEX	KOLOR COLOR
120-1043	● czarny black

EAN BARCODE



Szuflada na dokumenty  
GR-1779

Document tray  
GR-1779

INDEKS INDEX	KOLOR COLOR
120-1483	● czarny black

EAN BARCODE

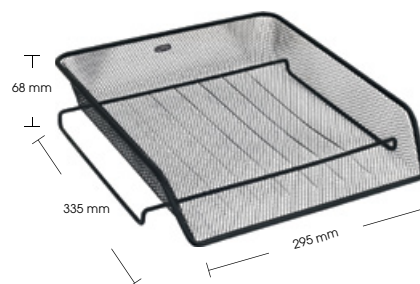

Szuflady na dokumenty  
GR-069 / GR-069S

Document tray  
GR-069 / GR-069S

INDEKS INDEX	KOLOR COLOR
120-1117	● czarny black
120-1118	● srebrny silver

EAN BARCODE

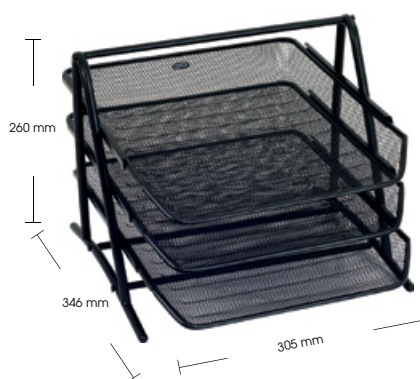

Stojak na dokumenty  
GR-1975

Tray with riser  
GR-1975

INDEKS INDEX	KOLOR COLOR
* 120-1781	● czarny black
* do wyczerpania zapasów while stock lasts	

EAN BARCODE

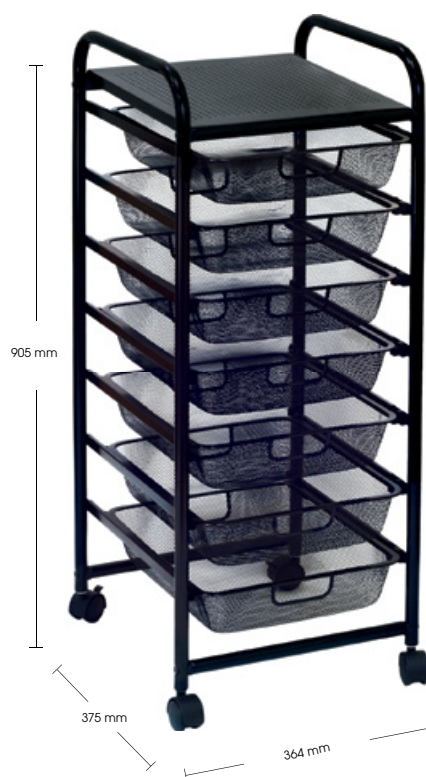



Kosz na papier  
GR-020 / GR-020S

• pojemność 12 l

Waste basket  
GR-020 / GR-020S

• capacity 12 l

INDEKS INDEX	KOLOR COLOR
120-1127	● czarny black
120-1128	○ srebrny silver

EAN BARCODE

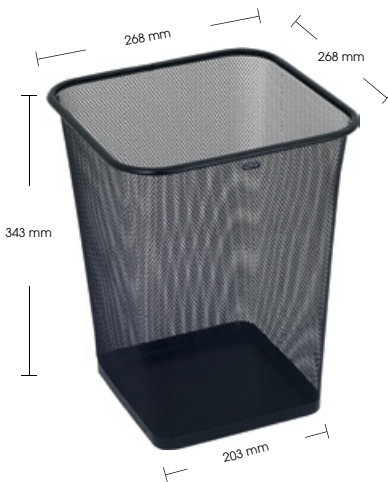

Kosz na papier kwadratowy  
GR-017 / GR-017S

• pojemność 18 l

Square waste basket  
GR-017 / GR-017S

• capacity 18 l

INDEKS INDEX	KOLOR COLOR
120-1459	● czarny black
120-1460	○ srebrny silver

EAN BARCODE

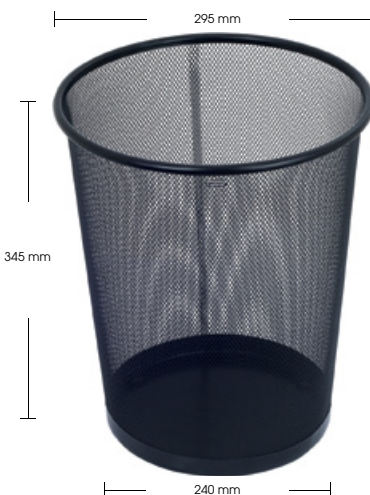

Kosz na papier  
GR-018 / GR-018S

• pojemność 19 l

Waste basket  
GR-018 / GR-018S

• capacity 19 l

INDEKS INDEX	KOLOR COLOR
120-1332	● czarny black
120-1333	○ srebrny silver

EAN BARCODE



## Seria NOTOdesk

- przyborniki biurkowe do samodzielnego składania
- nowoczesna forma, wyraziste kolory
- możliwe łączenie elementów w różnych kolorach, by stworzyć unikalny produkt
- wykonane z polipropylenu

### Pojemnik na długopisy NOTOdesk GR-3001

**INDEKS INDEX KOLOR COLOR**

120-1880 ● niebieski blue

★ 120-1881 ● różowy pink

★ do wyczerpania zapasów while stock lasts

### Przybornik NOTOdesk GR-3004

**INDEKS INDEX KOLOR COLOR**

120-1885 ● niebieski blue

120-1884 ● różowy pink

### Szuflada na dokumenty NOTOdesk GR-3002

**INDEKS INDEX KOLOR COLOR**

120-1883 ● niebieski blue

★ 120-1882 ● różowy pink

★ do wyczerpania zapasów while stock lasts

## NOTOdesk collection

- self-assembled desk organizers
- modern design, vivid colors
- connect elements in various colors to obtain unique product
- made of polypropylene

Grand®



### Pen holder NOTOdesk GR-3001

**EAN BARCODE**

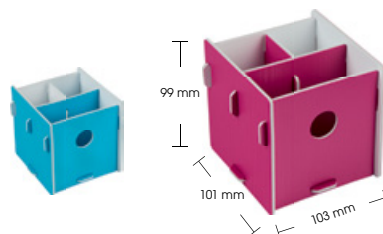

### Stationery holder NOTOdesk GR-3004

**EAN BARCODE**

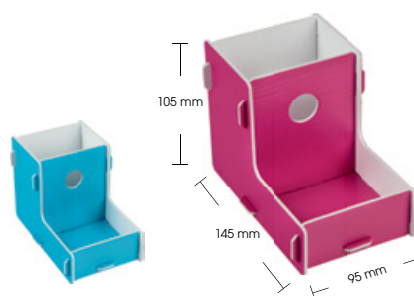

### Document tray NOTOdesk GR-3002

**EAN BARCODE**

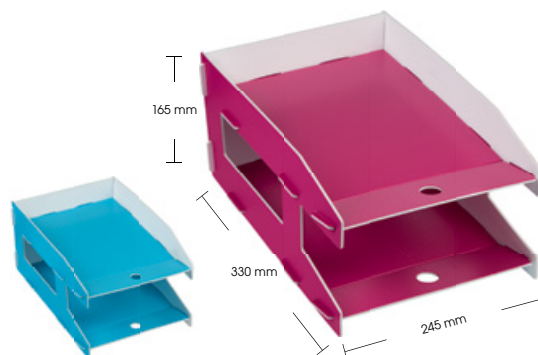

do samodzielnego składania:

self-assembled:

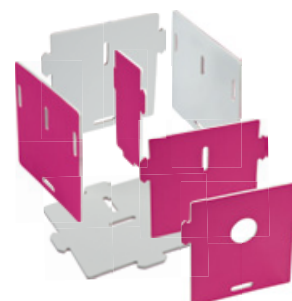
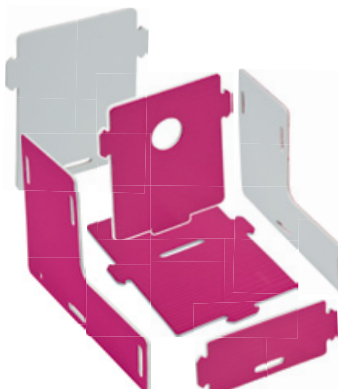
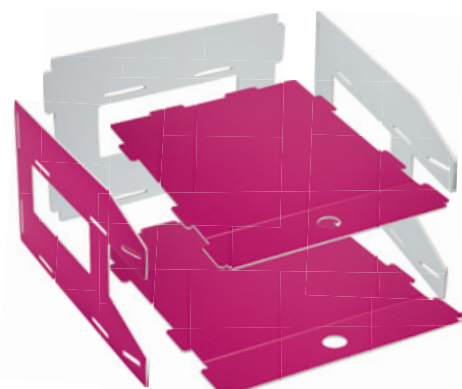

## Przybornik TY330S / TY330B

### W ZESTAWIE:

- zszywacz
- rozszywacz
- nożyczki
- nóż do papieru
- temperówka
- gumka do ścierania
- linijka 15 cm
- wbudowany uchwyt do taśmy z obcinaczem
- długopisy (3 szt.)
- pinezki tablicowe (20 szt.)
- spinacze (30 szt.)
- zszywki #10 (1 opak.)
- taśma klejąca 12x10
- notes 67x90 mm

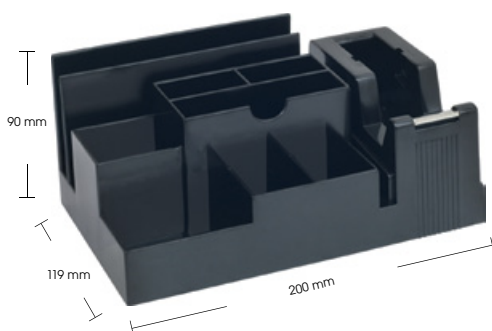

## Stationery holder TY330S / TY330B

### CONTAINS:

- stapler
- staple remover
- scissors
- paper knife
- pencil sharpener
- eraser
- ruler 15 cm
- integrated tape dispenser with cutter
- pens (3 pcs.)
- board thumb tacks (20 pcs.)
- paper clips (30 pcs.)
- staples #10 (1 box)
- adhesive tape 12x10
- notepad 67x90 mm

INDEKS INDEX	TYP TYPE	OPIS MODEL	EAN BARCODE
120-1066	330S	z wyposażeniem equipped	
120-1065	330B	bez wyposażenia empty	

## Przybornik TY370S / TY370B

### OBROTOWY. W ZESTAWIE:

- zszywacz
- rozszywacz
- nożyczki
- nóż do papieru
- temperówka
- gumka do ścierania
- linijka 15 cm
- długopisy (4 szt.)
- pinezki tablicowe (20 szt.)
- spinacze (30 szt.)
- zszywki #10 (1 opak.)
- taśma klejąca 12x10 z uchwytem
- notes 63x63 mm

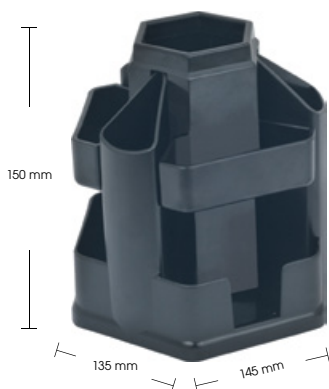

## Stationery holder TY370S / TY370B

### ROTARY. CONTAINS:

- stapler
- staple remover
- scissors
- paper knife
- pencil sharpener
- eraser
- ruler 15 cm
- pens (4 pcs.)
- board thumb tacks (20 pcs.)
- paper clips (30 pcs.)
- staples #10 (1 box)
- adhesive tape 12x10 with dispenser
- notes 63x63 mm

INDEKS INDEX	TYP TYPE	OPIS MODEL	EAN BARCODE
120-1068	370S	z wyposażeniem equipped	
120-1067	370B	bez wyposażenia empty	

## Przybornik TY380S / TY380B

### W ZESTAWIE:

- zszywacz
- rozszywacz
- nożyczki
- nóż do papieru
- temperówka
- gumka do ścierania
- linijka 15 cm
- długopisy (4 szt.)
- pinezki tablicowe (20 szt.)
- spinacze (30 szt.)
- zszywki #10 (1 opak.)
- notes 57x96 mm

## Stationery holder TY380S / TY380B

### CONTAINS:

- stapler
- staple remover
- scissors
- paper knife
- pencil sharpener
- eraser
- ruler 15 cm
- pens (4 pcs.)
- board thumb tacks (20 pcs.)
- paper clips (30 pcs.)
- staples #10 (1 box)
- notepad 57x96 mm

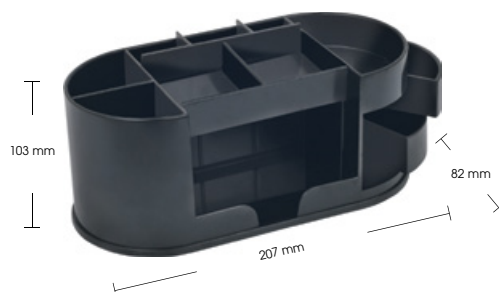

INDEKS	INDEX	TYP	TYPE	OPIS	MODEL	EAN	BARCODE
120-1070		380S		z wyposażeniem	equipped	5 903364 210359	
120-1069		380B		bez wyposażenia	empty	5 903364 210540	

## Przybornik TY730S / TY730B

### OBROTOWY. W ZESTAWIE:

- zszywacz
- rozszywacz
- nożyczki
- nóż do papieru
- temperówka
- gumka do ścierania
- linijka 15 cm
- długopisy (3 szt.)
- pinezki tablicowe (15 szt.)
- spinacze (20 szt.)
- zszywki #10 (1 opak.)

## Stationery holder TY730S / TY730B

### ROTARY. CONTAINS:

- stapler
- staple remover
- scissors
- paper knife
- pencil sharpener
- eraser
- ruler 15 cm
- pens (3 pcs.)
- board thumb tacks (15 pcs.)
- paper clips (20 pcs.)
- staples #10 (1 box)



INDEKS	INDEX	TYP	TYPE	OPIS	MODEL	EAN	BARCODE
120-1075		730S		z wyposażeniem	equipped	5 903364 210397	
120-1074		730B		bez wyposażenia	empty	5 903364 210588	



## Szafki metalowe

- zamykane na klucz: wszystkie szuflady
- przydatne w realizacji przepisów RODO

## Metal document cabinets

- key lock: all drawers
- useful in complementation of GDPR regulations



### YL-SM05

- zamykana na klucz: wszystkie szuflady
- 5 szuflad A4
- wzmocniona konstrukcja
- antypoślizgowe nóżki

### YL-SM05

- key lock: all drawers
- 5 drawers of A4 format
- strengthened construction
- on-slip feet



INDEKS INDEX

120-1777

EAN BARCODE



### YL-SM07M

- zamykana na klucz: wszystkie szuflady
- 7 szuflad A4

### YL-SM07M

- key lock: all drawers
- 7 drawers of A4 format



INDEKS INDEX

120-1778

EAN BARCODE



### YL-SM07

- zamykana na klucz: wszystkie szuflady
- 7 szuflad A4
- wzmocniona konstrukcja
- antypoślizgowe nóżki

### YL-SM07

- key lock: all drawers
- 7 drawers of A4 format
- strengthened construction
- on-slip feet



INDEKS INDEX

120-1780

EAN BARCODE

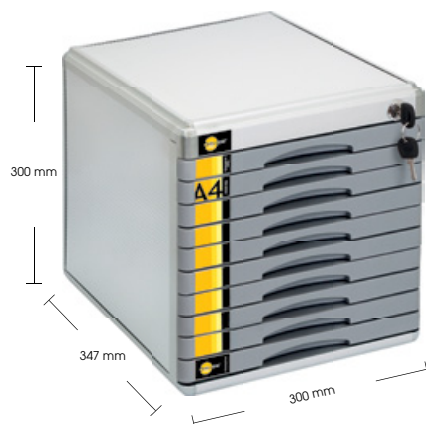

### YL-SM10

- zamykana na klucz: wszystkie szuflady
- 10 szuflad A4

### YL-SM10

- key lock: all drawers
- 10 drawers of A4 format



INDEKS INDEX

120-1779

EAN BARCODE



## Szafki plastikowe

- zamykane na klucz: wszystkie szuflady
- przydatne w realizacji przepisów RODO

## Plastic document cabinets

- key lock: all drawers
- useful in complementation of GDPR regulations



### GR-SP10

- zamykana na klucz: wszystkie szuflady
- 10 szuflad A4
- okna opisowe

### GR-SP10

- key lock: all drawers
- 10 drawers of A4 format
- description tags

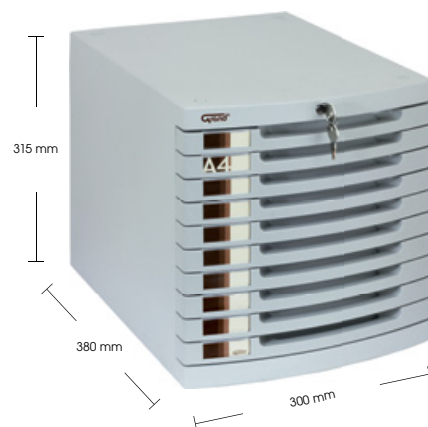

#### INDEKS INDEX

★ 120-1786

#### EAN BARCODE



★ do wyczerpania zapasów while stock lasts

## Szafki plastikowe

- zamykane na klucz: wszystkie szuflady
- otwory wentylacyjne z tyłu szafki
- możliwość łączenia szafek w pionie
- przydatne w realizacji przepisów RODO

## Plastic document cabinets

- key lock: all drawers
- ventilated back
- vertical storage possible
- useful in complementation of GDPR regulations



### YL-SP03

- 3 szuflady A4

### YL-SP03

- 3 drawers of A4 format



#### INDEKS INDEX

#### KOLOR COLOR

120-1889

● granatowy navy blue

120-1890

○ szary grey

#### EAN BARCODE

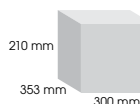

### YL-SP05

- 5 szuflad A4

### YL-SP05

- 5 drawers of A4 format



#### INDEKS INDEX

#### KOLOR COLOR

120-1891

● granatowy navy blue

120-1892

○ szary grey

#### EAN BARCODE

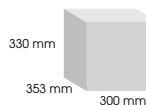





## Szafki plastikowe

## Plastic document cabinets



- zamykana na klucz: wszystkie szuflady
- key lock: all drawers

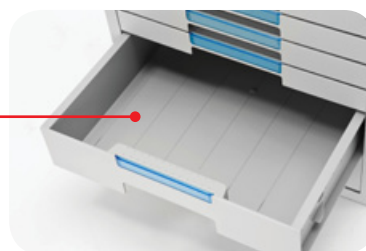

- wygodne szuflady
- comfortable drawers



- etykieta opisowa
- descriptive tag



- stabilne wysunięcie
- stable drawer guides



- łatwe otwieranie szuflady
- easy opening

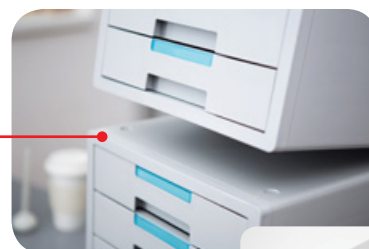

- łączenie w pionie
- connect



- łatwe wyjmowanie dokumentów
- easy picking up

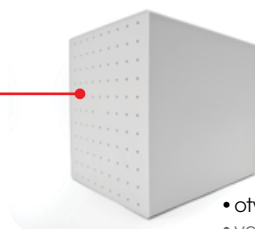

- otwory wentylacyjne
- ventilated back

## Szafki plastikowe

- zamykane na klucz: wszystkie szuflady
- otwory wentylacyjne z tyłu szafki
- możliwość łączenia szafek w pionie
- przydatne w realizacji przepisów RODO

## Plastic document cabinets

- key lock: all drawers
- ventilated back
- vertical storage possible
- useful in complementation of GDPR regulations



### YL-SP03GY

- 3 szuflady A4

INDEKS INDEX EAN BARCODE  
120-1895 

### YL-SP03GY

- 3 drawers of A4 format

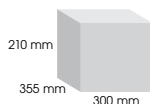

### YL-SP05GY

- 5 szuflad A4

INDEKS INDEX EAN BARCODE  
120-1893 

### YL-SP05GY

- 5 drawers of A4 format

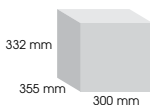

### YL-SP10GY

- 10 szuflad A4

INDEKS INDEX EAN BARCODE  
120-1894 

### YL-SP10GY

- 10 drawers of A4 format

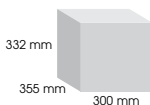

## Szafki plastikowe YL-SP04NF

- szuflady otwarte
- miejsce na etykietę opisową

## Plastic document cabinets YL-SP04NF



- open trays
- description tag



INDEKS INDEX KOLOR COLOR EAN BARCODE

120-1896  szary grey 

120-1905  żółty yellow 

120-1906  niebieski blue 

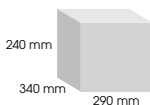

## Kasetki na pieniądze 8878

- metalowe kasetki lakierowane, o zaokrąglanych brzegach
- zamykane na kluczyk (w zestawie 2 kluczyki)
- posiadają plastikową tackę z przegródkami:  
model XS – 4 przegródki,  
modele S, M, L – 5 przegródek

## Cash box 8878

- metal cash box with rounded edges
- key lock (2 keys included)
- inner tray for coins and notes:  
XS – 4 compartments,  
S, M, L – 5 compartments



### 8878 XS

• 70x120x153 mm



INDEKS INDEX	KOLOR COLOR
120-1033	● czarny black
120-1034	● czerwony red
120-1035	● niebieski blue

#### EAN BARCODE



### 8878 S

• 77x157x207 mm



INDEKS INDEX	KOLOR COLOR
120-1029	● czarny black
120-1030	● czerwony red
120-1031	● niebieski blue

#### EAN BARCODE



### 8878 M

• 82x192x262 mm



INDEKS INDEX	KOLOR COLOR
120-1026	● czarny black
120-1027	● czerwony red
120-1028	● niebieski blue

#### EAN BARCODE



### 8878 L

• 100x217x300 mm



INDEKS INDEX	KOLOR COLOR
120-1023	● czarny black
120-1024	● czerwony red
120-1025	● niebieski blue

#### EAN BARCODE



## Pojemnik na kable

- pozwala zachować porządek estetyczny i funkcjonalny: ukrywa zbyt długie kable sprzętów RTV, komputerów, zasilaczy, ładowarek i innych, a jednocześnie gromadzi w jednym miejscu wszystkie przydatne wtyczki
- chroni kable przed kurzem i wilgocią
- stanowi zabezpieczenie przed dziećmi i zwierzętami
- minimalistyczny wzór

## Cable organizer

- enables to keep aesthetic and functional order: it hides long cables of RTV equipment, computers, power supplies and chargers, and keeps all plugs in one spot
- protects cables from dust and moisture
- provides protection against children and animals

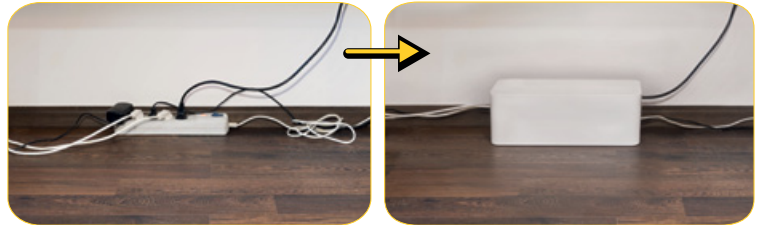

### YL-PK320

- 320x135x125 mm

INDEKS	INDEX	KOLOR	COLOR	EAN	BARCODE
120-1933		○ biały	white	5 903364 277734	
120-1934		● czarny	black	5 903364 277741	



### YL-PK405

- 405x155x135 mm

INDEKS	INDEX	KOLOR	COLOR	EAN	BARCODE
120-1935		○ biały	white	5 903364 277710	
120-1936		● czarny	black	5 903364 277727	



## Szafki na klucze

- metalowe
- zamykane na klucz (w zestawie dwa kluczyki)

## Key box

- metal key box
- key lock (2 keys included)

Grand®

### GR-CZ20

- mieści 20 kluczy
- 200x160x80 mm

### GR-CZ20

- capacity: 20 keys
- 200x160x80 mm

INDEKS	INDEX	EAN	BARCODE
120-1860		5 903364 217884	



### GR-CZ48

- mieści 48 kluczy
- 250x180x80 mm

### GR-CZ48

- capacity: 48 keys
- 250x180x80 mm

INDEKS	INDEX	EAN	BARCODE
120-1861		5 903364 217891	





## Pudełka na wizytówki 808

- trwałe tworzywo
- automatyczne otwieranie
- 24 przeladki alfabetyczne (A-Z)



### 808S

- mieści do 350 wizytówek
- 75x101x146 mm
- capacity: up to 350 name cards
- 75x101x146 mm

INDEKS INDEX	KOLOR COLOR	EAN BARCODE
120-1081	● czarny black	5 903364 207175
120-1081	● niebieski blue	5 903364 209117

## Name card holder 808

- durable material
- automatic opening
- 24 alphabetical dividers (A-Z)

### 808M

- mieści do 550 wizytówek
- 75x101x197 mm
- capacity: up to 550 name cards
- 75x101x197 mm

INDEKS INDEX	KOLOR COLOR	EAN BARCODE
120-1080	● czarny black	5 903364 207151
120-1080	● niebieski blue	5 903364 209094

## Tablica suchościeralna

- tablica do pisania i rysowania
- dołączony pisak suchościeralny z gąbką na zatyczce
- rysunki wykonane na tablicy można łatwo zetrzeć na sucho lub poprawić
- pomoc w nauce czy planowaniu pracy

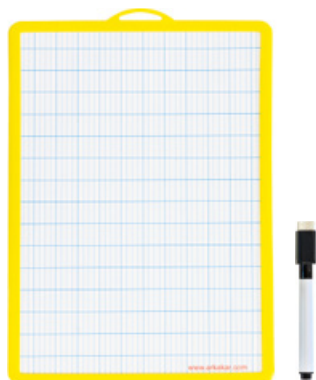

## White board

- board for writing and drawing
- marker with sponge on cap attached
- drawings can be easily wiped or corrected
- useful in learning or making schedules

INDEKS INDEX	ROZMIAR SIZE	EAN BARCODE
120-1928	235x323 mm	8 690857 004720



## Tablice korkowe w ramie drewnianej

- płyta porowata pokryta wysokiej jakości korkiem portugalskim
- rama z litego drewna sosnowego 20x20 mm
- w komplecie zestaw kołków do mocowania



## Cork boards in wooden frame

- plate covered with high-quality Portuguese cork
- frame made of solid pine wood 20x20 mm
- set of handles included

INDEKS INDEX	SYMBOL SYMBOL	ROZMIAR SIZE	EAN BARCODE
120-1519	5000	30x40 cm	5 903364 263355
120-1517	5002	40x50 cm	5 903364 263331
120-1516	5003	40x60 cm	5 903364 263324
120-1515	5004	50x60 cm	5 903364 263317
120-1496	5005	50x80 cm	5 903364 263287

INDEKS INDEX	SYMBOL SYMBOL	ROZMIAR SIZE	EAN BARCODE
120-1495	5006	60x80 cm	5 903364 263270
120-1514	5007	60x90 cm	5 903364 263300
120-1493	5009	80x100 cm	5 903364 263256
120-1768	5022	80x120 cm	5 903364 263362

kleie i taśmy  
glues & tapes

**AMOS**<sup>®</sup>

## wspólnie dla dzieci

kupując klej AMOS  
wspierasz program dożywiania dzieci  
[www.pajacyk.pl](http://www.pajacyk.pl)



Pajacyk to program, w ramach którego Polska Akcja Humanitarna od 1998 roku pomaga dzieciom i młodzieży w Polsce. Pajacyk finansuje posiłki i działania na rzecz ochrony zdrowia psychicznego. Celem programu jest zdrowie i prawidłowy rozwój każdego dziecka.

Łącznie przez wszystkie lata trwania programu dożywianie objęło 74 906 dzieci we wszystkich regionach Polski.

Nowym działaniem jest pomoc psychospołeczna dla dzieci: współpraca z organizacjami, konsultacje indywidualne i grupowe dla potrzebujących.

Kupując klej AMOS, włączasz się w te akcje.

**AMOS**<sup>®</sup>

## wspólnie dla środowiska

Akcja wymiany pustych tubek na kleje AMOS trwa. Proste zasady, atrakcyjna nagroda, a dla dzieci dobra zabawa i jednocześnie nauka odpowiedzialności. Zapraszamy każdą organizację edukacyjną i opiekuńczą w Polsce, a także biura, sklepy i hurtownie.

1. Zgłoś się do Akcji na [www.najlepszyklej.pl](http://www.najlepszyklej.pl)
2. Zbierz **120** pustych tubek po kleju AMOS
3. Przyślij je do nas
4. Otrzymasz **30** klejów **GRATIS**

**sprawdź szczegóły:**  
[www.najlepszyklej.pl](http://www.najlepszyklej.pl)



**ZBIERAJ**  
puste tubki

**ZYSKAJ**  
kleje **GRATIS**

## Klej w sztyfcie

- wysokiej jakości klej w sztyfcie
- bezbarwny i bezwonny
- zmywalny i niebrudzący
- zawiera PVP
- nie zawiera kwasów ani rozpuszczalników
- przeznaczony do papieru, fotografii, tektury i tkanin
- zgodny z normami ASTM oraz CE
- przebadany w The Art & Creative Materials Institute, INC. USA

## Glue stick

- high quality
- colorless, odorless
- washable & clean
- contains PVP
- acid-free & solvent-free
- for paper, photos, cardboard, fabrics
- conforms to ASTM & CE
- tested in The Art & Creative Materials Institute, INC. USA

**AMOS**<sup>®</sup>



INDEKS INDEX	SZTYFT STICK	SZEROKOŚĆ KLEJENIA STICKING WIDTH	EAN BARCODE
130-1071	8 g	15 mm	5 903364 231170
130-1864	10 g	17 mm	5 903364 279349
130-1068	15 g	19 mm	5 903364 231194
130-1069	22 g	23 mm	5 903364 231217
130-1070	35 g	26 mm	5 903364 231231



## Klej w sztyfcie display

- zawiera kleje:  
20 x 8 g  
20 x 15 g  
12 x 22 g  
10 x 35 g

## Glue stick display

- contains glue sticks:  
20 x 8 g  
20 x 15 g  
12 x 22 g  
10 x 35 g

INDEKS INDEX	EAN BARCODE
130-1589	5 903364 233143



klej AMOS

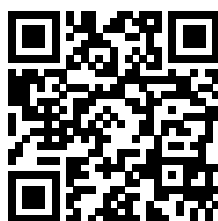
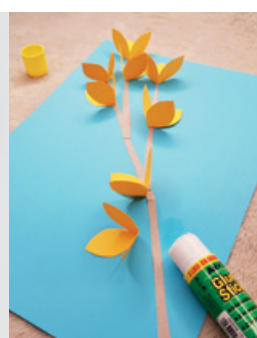

[www.najlepszyklej.pl](http://www.najlepszyklej.pl)





**Klej w sztyfcie  
– zestaw**

Glue stick set



INDEKS INDEX ZESTAW SET

130-1811 2x AMOS 22 g + dodatkowy klej AMOS  
2x AMOS 22 g + additional AMOS Glue Stick

EAN BARCODE



**Klej w sztyfcie K**

Glue stick K

- dobre właściwości klejące
- bezbarwny
- niebrudzący, zmywalny wodą
- przeznaczony do papieru i tektury

- good adhesive features
- colorless
- clean, washable
- for paper and cardboard



INDEKS INDEX SZTYFT STICK

130-1078 9 g 13 mm  
130-1076 18 g 18 mm  
130-1077 36 g 22 mm

SZEROKOŚĆ KLEJENIA STICKING WIDTH

EAN BARCODE



**Klej w płynie K**

Liquid glue K

- dobre właściwości klejące
- bezbarwny
- na bazie wody
- niebrudzący
- do papieru i tektury

- good adhesive features
- colorless
- water-based
- clean
- for paper and cardboard



INDEKS INDEX POJEMNOŚĆ CAPACITY

130-1064 30 ml  
130-1065 40 ml  
130-1066 50 ml

EAN BARCODE



## Klej biały uniwersalny White Craft

AMOS®

- wysokiej jakości klej w płynie
- zmywalny
- przezroczysty po wyschnięciu
- elastyczny po wyschnięciu – nie kruszy się
- przeznaczony do papieru, drewna i tkanin
- 2 końcówki: szeroka do dużych powierzchni i wąska do precyzyjnego dozowania

### White Craft glue

- high quality liquid glue
- washable
- dries clear
- dries elastic – no crumbling
- for paper, wood and fabrics
- two tips: wide for large areas and narrow for precise application

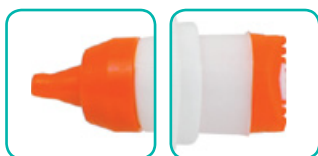

CE



INDEKS INDEX POJEMNOŚĆ CAPACITY

130-1488 34 ml

EAN BARCODE



## Klej w płynie dwustronny

AMOS®

- wysokiej jakości
- bezbarwny, bezwonny
- niebrudzący
- zmywalny
- nie zawiera kwasów
- 2 końcówki: szeroka do dużych powierzchni i wąska do precyzyjnego dozowania
- do papieru i tektury

### Liquid glue

- high quality
- colorless, odorless
- clean
- washable
- acid-free
- two tips: wide for large areas and narrow for precise application
- for paper and cardboard



CE



INDEKS INDEX POJEMNOŚĆ CAPACITY

130-1855 34 ml

EAN BARCODE



## Klej Blue Glue

- do papieru i tektury
- naturalny
- zmywalny
- bezpieczny dla rąk
- skleja stopniowo
- przezroczysty po wyschnięciu
- pozostawić do wyschnięcia od 5 do 15 minut w temperaturze pokojowej



INDEKS INDEX

SYMBOL SYMBOL

POJEMNOŚĆ CAPACITY

EAN BARCODE

\* 130-1833

GR-FBG-6

60 ml



\* 130-1834

GR-FBG-1

1000 ml



\* do wyczerpania zapasów while stock lasts

## Blue Glue

- for paper and cardboard
- natural
- washable
- safe for hands
- gradually adheres
- transparent after dry
- leave to dry for 5-15 min. in room temperature

fiorello®





## Żelowe kropki mocujące w rolce YL-10300

- samoprzylepne, dwustronne
- średnica 10 mm
- umożliwiają łączenie lekkich przedmiotów z większością powierzchni
- do przyklejania zdjęć, plakatów, karteczek
- po odklejeniu nie pozostawiają śladów na gładkich powierzchniach
- zastępują klej i taśmę

## Clear glue dots in roll YL-10300

- self-adhesive, double-sided
- dot diameter 10 mm
- allow multiple bonding of lightweight objects to most surfaces
- for affixing photos, posters, cards
- leave smooth surfaces clean after removing
- replace glue or adhesive tape

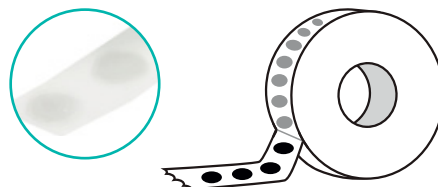

INDEKS INDEX ZAWIERA INCLUDES

125-1042 300 szt. pcs.

EAN BARCODE



## Masa mocująca

- samoprzylepna masa mocująca
- umożliwia wielokrotne łączenie lekkich przedmiotów z większością powierzchni
- do przyklejania zdjęć, plakatów, karteczek
- zastępuje taśmę, pinezki
- po odklejeniu nie pozostawia śladów na gładkich powierzchniach
- opakowanie zawiera 50 g masy podzielonej na 48 kostek

## Sticky Tack

- adhesive sticky pads
- allows multiple bonding of lightweight objects to most surfaces
- perfect for affixing photos, posters, cards
- replaces tape or thumb tacks
- leaves smooth surfaces clean after removing
- contains 50 g of sticky tack divided into 48 bricks



INDEKS INDEX OPAK. PACKAGING

125-1041 50 g, 48 kostek 50g, 48 bricks

EAN BARCODE

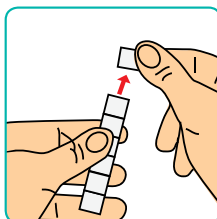

- oderwać kostkę
- tear off a brick

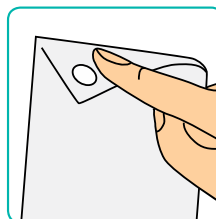

- nakleić
- stick

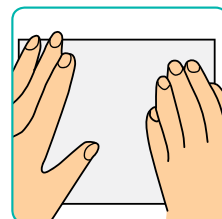

- docisnąć
- press



## Taśma dwustronna z uchwytem

- z uchwytem ułatwiającym odrywanie taśmy
- bezwonna
- pokryta emulsyjnym klejem akrylowym
- nie zawiera rozpuszczalników organicznych
- stabilna substancja klejąca odporna na działanie światła
- wzmocniona powłoka taśmy odporna na starzenie
- zastosowanie w szerokim zakresie temperatur

## Adhesive tape double-sided with dispenser

- dispenser enables tearing the tape off
- odorless
- covered with acrylic glue
- organic solvent-free
- stable sticking substance resistant to light
- strengthened tape surface resistant to aging
- ready to use in wide range of temperature



INDEKS INDEX ROZMIAR SIZE



130-1903 18 mm x 8,5 m

EAN BARCODE



## Taśma biurowa

- idealnie przezroczysta
- bezwonna, wykonana z polipropylenu
- grubość 40 mikronów
- pokryta emulsyjnym klejem akrylowym na bazie wody
- nie zawiera rozpuszczalników organicznych
- stabilna substancja klejąca odporna na działanie światła
- wzmocniona powłoka taśmy odporna na starzenie
- zastosowanie w szerokim zakresie temperatur

INDEKS INDEX	ROZMIAR SIZE	SŁUPEK SHRINK	EAN BARCODE
130-1278	12 x 10	12	 5 903364 234218
130-1280	12 x 20	12	 5 903364 234225
130-1281	12 x 30	12	 5 903364 234232
130-1282	18 x 10	8	 5 903364 234249
130-1283	18 x 20	8	 5 903364 234256
130-1284	18 x 30	8	 5 903364 234263
130-1794	19 x 33	8	 5 903364 234942
130-1285	24 x 10	6	 5 903364 234270
130-1286	24 x 20	6	 5 903364 234287
130-1287	24 x 30	6	 5 903364 234294

## Stationery tape



- perfectly transparent
- odorless, made of polypropylene
- 40 micrones thick
- covered with acrylic water-based glue
- organic solvent-free
- stable sticking substance resistant to light
- strengthened tape surface resistant to aging
- ready to use in wide range of temperature



## Taśma biurowa z uchwytem

- z uchwytem ułatwiającym odrywanie taśmy
- bezwonna
- wykonana z polipropylenu
- pokryta emulsyjnym klejem akrylowym
- nie zawiera rozpuszczalników organicznych
- stabilna substancja klejąca odporna na działanie światła
- wzmocniona powłoka taśmy odporna na starzenie
- zastosowanie w szerokim zakresie temperatur

## Adhesive tape with dispenser



- dispenser enables tearing the tape off
- odorless
- made of polypropylene
- covered with acrylic glue
- organic solvent-free
- stable sticking substance resistant to light
- strengthened tape surface resistant to aging
- ready to use in wide range of temperature

## Taśma biurowa MAGIC

- niewidoczna po przyklejeniu taśma, po której można pisać
- niewidoczna na fotokopiach
- idealna do naprawy zniszczonych dokumentów, książek itp.

## Taśma biurowa

- idealnie przezroczysta

## Adhesive tape

- perfectly transparent



## MAGIC adhesive tape

- invisible after application, possible to write on
- invisible on photocopies
- perfect for repairing damage documents, books etc.

INDEKS INDEX	ROZMIAR SIZE	EAN BARCODE
130-1277	18 x 20	 5 903364 234447

INDEKS INDEX	ROZMIAR SIZE	EAN BARCODE
130-1288	18 x 20	 5 903364 234454



## Uchwyty do taśmy 898S / 898M

- małe, wygodne uchwyty z obcinaczem
- wytrzymałe tworzywo sztuczne
- stabilna podstawa
- maks. rozmiar taśmy: 19 x 33



19x33  
taśma  
tape

### 898S

INDEKS INDEX	KOLOR COLOR	EAN BARCODE
130-1339	● czarny black	5 903364 201135
130-1340	● czerwony red	5 903364 201210
130-1342	● niebieski blue	5 903364 201166

## Tape dispensers 898S / 898M

- small, comfortable tape dispensers with cutter
- made of durable material
- stable base
- max tape size: 19 x 33



### 898M

INDEKS INDEX	KOLOR COLOR	EAN BARCODE
130-1334	● czarny black	5 903364 201036
130-1336	● niebieski blue	5 903364 201050



## Uchwyt do taśmy Axa T5112B

- wykonany z trwałego materiału
- stabilna podstawa
- spód antypoślizgowy
- maks. rozmiar taśmy: 19 x 25



19x25  
taśma  
tape

INDEKS INDEX	KOLOR COLOR
130-1555	● biało-pomarańczowy white&orange
130-1554	● biało-niebieski white&blue

## Tape dispenser Axa T5112B

- made of durable material
- stable non-slip base
- max tape size: 19 x 25



EAN BARCODE



## Automatyczny podajnik do taśmy T5165AB

- korpus z trwałego tworzywa sztucznego, konstrukcja wewnętrzna plastikowa
- bardzo mocne ostrze tnące taśmę, schowane w obudowie – bezpieczne w użytkowaniu
- przenośny i wygodny w użyciu, lekki i wytrzymały, ułatwia pracę na wysokości
- ręczna regulacja żądanej długości taśmy ułatwia pracę, np. przy pakowaniu prezentów
- w zestawie dwie rolki taśmy: 19 x 33 oraz 12 x 33



12x33  
taśma  
tape

19x33  
taśma  
tape

INDEKS INDEX	KOLOR COLOR
130-1846	○ biały white
130-1847	● szary grey
130-1844	● fioletowy violet
130-1845	● różowy pink

## Handheld tape dispenser T5165AB

- body made of durable material, inner construction made of plastic
- cutting blade very strong & safe to use, tucked in casing
- portable and comfortable, light and durable, easy to use at heights
- manual control of tape length facilitates use, eg. gift wrapping
- two tape rolls included: 19 x 33 and 12 x 33



EAN BARCODE



## Uchwyt do taśmy Ha! TYT581

- niewielki, wygodny uchwyt z obcinaczem
- maks. rozmiar taśmy: 22 x 50



INDEKS INDEX	KOLOR COLOR	EAN BARCODE
130-1899	niebieski blue	5 903364 219307
130-1900	różowy pink	5 903364 219321
130-1901	żółty yellow	5 903364 219345

## Tape dispenser Ha! TYT581

- small, comfortable tape dispenser with a cutter
- max tape size: 22 x 50



**Ha!**

pojemnik na długopisy – s. 51  
pen holder – see p. 51

**Ha!**

dziurkacz, zszywacz – s. 6  
punch, stapler – see p. 6

## Taśma pakowa

- taśma pakowa BOPP
- wykonana z polipropylenu, pokryta klejem akrylowym
- przyczepna do większości powierzchni
- odporna na zrywanie
- doskonała do zaklejania kartonów o szerokim zakresie wag
- przyjazna dla środowiska – nie zawiera substancji trujących
- stabilna substancja klejąca odporna na działanie światła
- wzmocniona powłoka taśmy odporna na starzenie
- zastosowanie w szerokim zakresie temperatur

## Packing tape

- BOPP packing tape
- made of polypropylene, covered with acrylic glue
- adhesive to most surfaces, resistant to tearing
- perfect for sealing boxes of different weight
- environmentally friendly – contains no poisonous substances
- stable sticking substance resistant to light
- strengthened tape surface resistant to aging
- ready to use in wide range of temperature



KOLOR COLOR	ROZMIAR SIZE	48 x 50	48 x 66
● brązowa brown		130-1272 5 903364 234423	130-1274 5 903364 234522
○ przezroczysta transparent		130-1273 5 903364 234430	130-1275 5 903364 234539



KOLOR COLOR	ROZMIAR SIZE	12 x 50	48 x 50
● czerwony red		130-1225 5 903364 234119	130-1243 5 903364 234171
● niebieski blue		130-1226 5 903364 234089	130-1244 5 903364 234140
● żółty yellow		130-1230 5 903364 234126	130-1247 5 903364 234188
● czarny black		130-1224 5 903364 234072	130-1242 5 903364 234133
● pomarańczowy orange		130-1227 5 903364 234102	130-1245 5 903364 234164
● zielony green		130-1229 5 903364 234096	130-1246 5 903364 234157
○ biały white		130-1223 5 903364 234492	130-1271 5 903364 234478



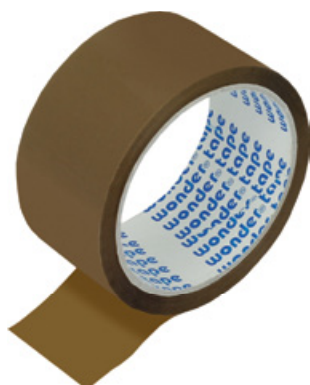

## Taśma pakowa A2K

- wysokiej jakości taśma pakowa
- o dużej mocy klejenia, wytrzymała
- wyprodukowana na bazie polipropylenu
- pokryta klejem akrylowym, co gwarantuje odporność na rozciąganie
- zastosowanie w szerokim zakresie temperatur: od -30°C do 100°C



-30-100  
°C

INDEKS INDEX	KOLOR COLOR	ROZMIAR SIZE	EAN BARCODE
130-1265	● brązowy brown	48 x 50	 5 903364 232313
130-1267	○ przezroczysty transparent	48 x 50	 5 903364 232375
130-1264	○ biały white	48 x 50	 5 903364 232412

Grubość (mm)	Wytrzymałość na rozciąganie (kg/mm)	Siła przylepności (kg/mm)	Thickness (mm)	Resistance to stretching (kg/mm)	Adhesion strength (kg/mm)
<b>0,045</b>	<b>8,16 kg / 25 mm</b>	<b>0,46 kg / 25 mm</b>	0,045	8,16 kg / 25 mm	0,46 kg / 25 mm

## Packing tape A2K

- high quality
- durable, good adhesive features
- based on polypropylene
- covered with acrylic glue that provides resistance to stretching
- ready to use in wide range of temperature: from -30°C to 100°C



## Taśma pakowa srebrna

- taśma zbrojona 48 mm x 10 m
- klej na bazie kauczuku naturalnego



## Silver packing tape

- reinforced tape 48 mm x 10 m
- adhesive based on natural rubber

INDEKS INDEX	EAN BARCODE
130-1716	 5 903364 234935

## Oklejarka do taśmy pakowej

- uniwersalna metalowa oklejarka ręczna do taśmy pakowej
- mechanizm naciągu taśmy zabezpiecza przed jej zwijaniem
- element dociskający taśmę do klejonej powierzchni
- ergonomiczna, profilowana, plastikowa rękojeść
- przeznaczona do taśmy o maks. szerokości 50 mm
- duża: z napinanym sprężyną elementem dociskającym taśmę do rolki dyspensera



## Packing tape dispenser

- multi-purpose metal packing tape dispenser
- tape tension mechanism prevents from tape retraction
- element biasing tape to surface
- ergonomic profiled plastic handle
- max tape width: 50 mm
- big: with spring element biasing tape to dispenser roll

INDEKS INDEX	RODZAJ TYPE	EAN BARCODE
130-1193	mała small	 5 903364 234195
130-1196	duża big	 5 903364 234201



## Taśmy samoprzylepne specjalistyczne

## Special use adhesive tapes

### Taśma papierowa

- wytrzymała taśma do klejenia „na mokro”
- brązowa
- nie zawiera rozpuszczalników organicznych
- minimalizuje ryzyko niezauważonego dostępu do przesyłek

### Kraft paper gummed tape

- durable water tape
- brown
- organic solvent-free
- minimizes risk of unnoticed access to parcels

Grand®

INDEKS INDEX	ROZMIAR SIZE	EAN BARCODE
130-1298	36 mm x 105 m	5 903364 255015
130-1299	48 mm x 200 m	5 903364 255022
130-1300	60 mm x 200 m	5 903364 255039
130-1301	72 mm x 200 m	5 903364 255046



### Taśma lakiernicza

- jednostronnie przylepna taśma ochronna
- nie pozostawia śladów po odklejeniu
- może służyć do mocowania folii ochronnych
- odrywana ręcznie – bez konieczności używania nożyczek

### Masking tape

- adhesive protective tape
- leaves no trace after removing
- may be used to fix protective foils
- easy to tear off by hand – no need to use scissors

Grand®

INDEKS INDEX	ROZMIAR SIZE	EAN BARCODE
130-1248	19 mm x 40 m	5 903364 234928
130-1249	25 mm x 40 m	5 903364 234911
130-1250	30 mm x 40 m	5 903364 234904
130-1251	38 mm x 40 m	5 903364 234898
130-1252	48 mm x 40 m	5 903364 234881





## Taśmy samoprzylepne dwustronne

Double side adhesive tapes



### Taśma dwustronna

- po usunięciu zabezpieczającego paska papieru – przezroczysta
- odrywana ręcznie – bez konieczności używania nożyczek
- bardzo dobrze przylega do powierzchni
- nie rozwarstwia się
- odporna na kurczenie

### Double side tissue tape

- transparent after removing protective paper
- easy to tear off by hand – no need to use scissors
- very good adhesive features
- no stratifying
- resistant to shrinkage



INDEKS INDEX	ROZMIAR SIZE	OPAK. PKG.	EAN BARCODE
130-1205	8 mm x 25 m	12 szt. pcs.	
130-1208	38 mm x 5 m	8 szt. pcs.	
130-1206	38 mm x 10 m	8 szt. pcs.	
130-1207	38 mm x 25 m	8 szt. pcs.	
130-1211	50 mm x 5 m	6 szt. pcs.	
130-1209	50 mm x 10 m	6 szt. pcs.	
130-1210	50 mm x 25 m	6 szt. pcs.	



### Taśma montażowa

- dwustronnie klejąca taśma piankowa o grubości 1 mm
- przyczepna do większości sztywnych powierzchni
- zapewnia trwałe połączenia
- bezwonna
- wytrzymała na zrywanie
- przyjazna dla środowiska – nie zawiera substancji trujących
- stabilna substancja klejąca odporna na działanie światła
- wzmocniona powłoka taśmy odporna na starzenie
- zastosowanie w szerokim zakresie temperatur

### Double side foam tape

- double side foam tape, 1 mm thick
- adhesive to most stiff surfaces
- provides permanent joints
- odorless
- resistant to tearing
- environmentally friendly – contains no poisonous substances
- stable sticking substance resistant to light
- strengthened tape surface resistant to aging
- ready to use in wide range of temperature



INDEKS INDEX	ROZMIAR SIZE	OPAK. PKG.	EAN BARCODE
130-1212	12 mm x 3 m	1 szt. pc.	
130-1213	12 mm x 5 m	1 szt. pc.	
130-1214	18 mm x 3 m	1 szt. pc.	
130-1215	18 mm x 5 m	1 szt. pc.	
130-1216	24 mm x 3 m	1 szt. pc.	
130-1217	24 mm x 5 m	1 szt. pc.	



**office & school**  
**biurowe i szkolne**

## Nożyczki z miękkim uchwytem Soft

- ostrze wykonane z hartowanej nierdzewnej stali
- ręczki nożyczek wykonane z wytrzymałego tworzywa sztucznego, z miękkim gumowanym uchwytem
- ostre końcówki nożyczek umożliwiają precyzyjne wycinanie
- w ofercie także nożyczki dla osób leworęcznych (L)

## Scissors with soft handle

- blades made of tempered stainless steel
- handles made of durable material with soft rubber grip
- pointed tips enable precise cutting
- model for left-handed available (L)



INDEKS INDEX	SYMBOL SYMBOL	ROZMIAR SIZE	EAN BARCODE
130-1605	GR-5500	5" (12 cm)	5 903364 215903
130-1606	GR-5700	7" (17,5 cm)	5 903364 215927
130-1607	GR-5850	8,5" (21,5 cm)	5 903364 215941
130-1611	GR-6850	8,5" (21,5 cm) L	5 903364 216016
130-1608	GR-5100	10" (25 cm)	5 903364 215965

## Nożyczki z miękkim uchwytem Soft

- ręczki nożyczek wykonane z wytrzymałego tworzywa sztucznego
- miękki gumowany uchwyt
- końcówki zaokrąglone

## Scissors with soft handle

- handles made of durable material
- soft rubber grip
- round tips



INDEKS INDEX	SYMBOL SYMBOL	ROZMIAR SIZE	EAN BARCODE
130-1806	GR-5575	5,75" (14,5 cm)	5 903364 217655
130-1825	GR-5825	8,25" (21 cm)	5 903364 217679

## Nożyczki z miękkim uchwytem Soft tytanowe

- unikatowe, wewnątrz wklęsłe ostrza 3D zmniejszają do minimum powierzchnię styku podczas cięcia
- znacznie ostrzejsze niż klasyczne nożyczki: zmniejszone tarcie między ostrzami ułatwia cięcie
- proste precyzyjne cięcia, bez szarpania krawędzi
- powierzchnia odporna na przyklejanie taśmy samoprzylepnej i dwustronnej
- idealne także do cięcia tkanin, zdjęć i wszystkich typów papieru
- hartowane ostrza z utrwaloną termicznie powłoką tytanową



GR-9525



GR-9700



GR-9825

INDEKS INDEX	SYMBOL SYMBOL	ROZMIAR SIZE	EAN BARCODE
130-1859	GR-9525	5,25" (13 cm)	
130-1860	GR-9700	7" (17,5 cm)	
130-1861	GR-9825	8,25" (21 cm)	



## Scissors with soft handle titanium

- unique inner hollow 3D blades enable precise control of the friction force between the blades
- significantly sharper than standard scissors: reduced friction between blades makes cutting easier
- precise, straight cuts, no tearing of the edges
- surface resistant to sticking of adhesive tape
- perfect for fabrics, photos and all types of paper
- hardened blades with heat-treated titanium surface

Grand®



## Nożyczki z miękkim uchwytem Soft teflonowe

- unikatowe, wewnątrz wklęsłe ostrza 3D zmniejszają do minimum powierzchnię styku podczas cięcia
- znacznie ostrzejsze niż klasyczne nożyczki: zmniejszone tarcie między ostrzami ułatwia cięcie
- proste precyzyjne cięcia, bez szarpania krawędzi
- powierzchnia odporna na przyklejanie taśmy samoprzylepnej i dwustronnej
- idealne także do cięcia tkanin, zdjęć i wszystkich typów papieru
- pokrycie teflonem chroni przed rdzą i korozją



GR-8525



GR-8700



GR-8825

INDEKS INDEX	SYMBOL SYMBOL	ROZMIAR SIZE	EAN BARCODE
130-1856	GR-8525	5,25" (13 cm)	
130-1857	GR-8700	7" (17,5 cm)	
130-1858	GR-8825	8,25" (21 cm)	



## Scissors with soft handle teflon

- unique inner hollow 3D blades enable precise control of the friction force between the blades
- significantly sharper than standard scissors: reduced friction between blades makes cutting easier
- precise, straight cuts, no tearing of the edges
- surface resistant to sticking of adhesive tape
- perfect for fabrics, photos and all types of paper
- teflon coating protects against rust and corrosion

Grand®





## Nożyczki bursztynowe

- wysokiej jakości nożyczki z nierdzewnej, hartowanej stali
- ostre końcówki nożyczek umożliwiają precyzyjne wycinanie
- uchwyty z tworzywa sztucznego w kolorze bursztynowym

## Scissors with 'amber' handle

- high quality scissors made of tempered stainless steel
- pointed tips enable precise cutting
- handles made of amber-colored material



INDEKS INDEX	SYMBOL SYMBOL	ROZMIAR SIZE
130-1384	GR-3550	5,5" (13,5 cm)
130-1385	GR-3625	6,25" (16 cm)
130-1183	GR-3700	7" (17,5 cm)
130-1386	GR-3850	8,5" (21,5 cm)
130-1173	GR-3100	10" (25 cm)



### EAN BARCODE



## Nożyczki metalowe

- nierdzewna, hartowana stal
- GR-4800: ergonomiczny uchwyt z tworzywa sztucznego

## Metal scissors

- tempered stainless steel
- GR-4800: ergonomic grip made of material

Grand®



GR-4700

GR-4800

GR-4825



INDEKS INDEX	SYMBOL SYMBOL	ROZMIAR SIZE	EAN BARCODE
130-1610	GR-4700	7" (17,5 cm)	5 903364 215996
130-1185	GR-4800	8" (20,5 cm)	5 903364 210489
130-1848	GR-4825	8,25" (21 cm)	5 903364 217983



## Nożyczki z uchwytem ABS

- ergonomiczny uchwyt z tworzywa sztucznego
- nierdzewna, hartowana stal

## Scissors with ABS grip

- ergonomic grip made of ABS material
- tempered stainless steel

Grand®



GR-2650

GR-2651

GR-2850



INDEKS INDEX	SYMBOL SYMBOL	ROZMIAR SIZE	KOŃCÓWKI TIPS	EAN BARCODE
130-1181	GR-2650	6,5" (16,5 cm)	okrągłe round	5 903364 208325
130-1182	GR-2651	6,5" (16,5 cm)	ostre pointed	5 903364 208400
130-1184	GR-2850	8,5" (21,5 cm)	ostre pointed	5 903364 209698



ząbkowane



Precyzyjne cięcie i efekt  
delikatnej perforacji.

kieszonkowe

Zawsze pod ręką.  
Skuteczne i bezpieczne.

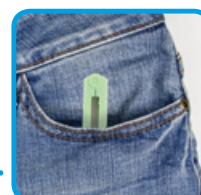
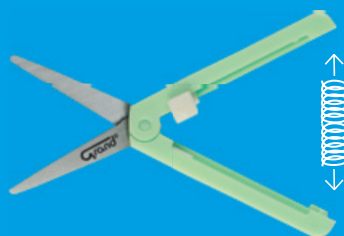

Łatwo mieszczą się w kieszeni, w torebce i w piórniku.

## Nożyczki ząbkowane GR-2600

- nożyczki ze stali nierdzewnej
- ergonomiczny uchwyt z tworzywa sztucznego
- antypoślizgowe ząbkowane brzożgi
- łatwo tną materiał oraz śliski, gruby papier
- gwarantują precyzyjne cięcie



**INDEKS INDEX** 130-1885 **SYMBOL SYMBOL** GR-2600 **ROZMIAR SIZE** 6" (15 cm)

## Scissors serrated edges GR-2600

- tempered stainless steel scissors
- ergonomic handles made of durable material
- non-slip serrated edges
- easy cutting of fabric or slippery, thick paper
- precise cutting

Grand®



## Nożyczki kieszonkowe GR-7425

- kieszonkowe nożyczki ze stali nierdzewnej z bezpiecznym zamknięciem
- doskonała jakość cięcia
- rozmiar po zamknięciu: 71 mm



**INDEKS INDEX** 130-1883 **SYMBOL SYMBOL** GR-7425 **ROZMIAR SIZE** 4.25" (11 cm)

## Pocket scissors GR-7425

- pocket tempered stainless steel scissors with safety lock
- excellent cutting quality
- size when closed: 71 mm

Grand®



## Nożyczki ECO

- nożyczki ze stali nierdzewnej
- doskonała jakość cięcia
- ergonomiczny uchwyt z tworzywa sztucznego z domieszką słomy



**INDEKS INDEX** 130-1892 **SYMBOL SYMBOL** GR-2675 **ROZMIAR SIZE** 6.75" (17 cm)  
130-1893 **SYMBOL SYMBOL** GR-2825 **ROZMIAR SIZE** 8.5" (21 cm)

## ECO scissors

- tempered stainless steel scissors
- excellent cutting quality
- ergonomic grip made of durable material and straw

Grand®







## Nożyczki szkolne

- wysokiej jakości nożyczki z nierdzewnej, hartowanej stali
- ergonomiczne uchwyty z tworzywa sztucznego w różnych kolorach

## School scissors

- high quality scissors, blades made of tempered stainless steel
- ergonomic grip made of color material



### GR-1502



INDEKS  
INDEX

OPAK.  
PKG.

EAN  
BARCODE

130-1176

30 szt.  
30 pcs.



### GR-1504

neonowe  
neon



INDEKS  
INDEX

OPAK.  
PKG.

EAN  
BARCODE

130-1178

30 szt.  
30 pcs.



### GR-1503



INDEKS  
INDEX

OPAK.  
PKG.

EAN  
BARCODE

\* 130-1177

12 szt.  
12 pcs.



\* do wyczerpania zapasów while stock lasts



### GR-6500

- sprężysty element ułatwiający rozwieranie
- przeznaczone dla osób leworęcznych
- resilient element for easy opening
- for left-handed



INDEKS  
INDEX

OPAK.  
PKG.

EAN  
BARCODE

130-1666

12 szt.  
12 pcs.



### GR-1507



INDEKS  
INDEX

OPAK.  
PKG.

EAN  
BARCODE

130-1664

12 szt.  
12 pcs.



## Nożyczki kwiatki GR-1509

- uchwyty w formie 3 różnych kwiatków
- bezpieczne przechowywanie – w doniczce



**INDEKS**  
INDEX  
130-1823

**OPAK.**  
PKG.  
9 szt.  
9 pcs.

**EAN**  
BARCODE



## Flower scissors GR-1509

- 3 different flower grips
- safe storage of flower scissors in flower pot



## Nożyczki-zwierzaki GR-1508

- nożyczki dziecięce w atrakcyjnych kształtach imitujących zwierzęta
- w opakowaniu 4 wzory: żabka, pingwin, rybka, sowa w różnych wersjach kolorystycznych
- wygodny, miękki uchwyt
- ostrza ze stali nierdzewnej



**INDEKS**  
INDEX  
130-1675

**OPAK.**  
PKG.  
24 szt.  
24 pcs.

**EAN**  
BARCODE



## Scissors 'Animals' GR-1508

- school scissors in shapes of animals
- four designs in display: frog, penguin, fish, owl, various color combinations
- comfortable soft grip
- stainless steel blades





### Nożyczki plastikowe GR-1510

- miękki uchwyt
- dwukolorowe plastikowe przybory

### Plastic scissors GR-1510

- soft grip
- two-color plastic utensils



5,25"

13 cm

INDEKS INDEX

130-1822

OPAK. PKG.

30 szt. pcs.

EAN BARCODE



### Nożyczki plastikowe GR-1511

- plastikowe
- kształt dostosowany do małej dłoni

### Plastic scissors GR-1511

- plastic
- designed for small hand



4,25"

11 cm

INDEKS INDEX

130-1862

OPAK. PKG.

20 szt. pcs.

EAN BARCODE



### Nożyczki dekoracyjne GR-7625

- nożyczki z wymiennymi ostrzami
- 5 wzorów cięcia
- zestaw zawiera uchwyt, 5 wymiennych ostrzy, narzędzie do bezpiecznej wymiany ostrzy

### Craft scissors GR-7625

- replaceable blades
- 5 cutting lines
- set includes grip, 5 replaceable blades, device for safe blades change



WZORY CIĘCIA

CUTTING LINES

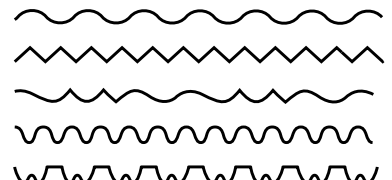

6,25"

16 cm

INDEKS INDEX

130-1674

EAN BARCODE



## Nóż do kopert GR-826

- ergonomiczny uchwyt w kolorze czarnym
- stal nierdzewna
- długość ostrza 11 cm



INDEKS INDEX

EAN BARCODE

130-1188



19  
cm

## Letter knife GR-826

Grand®

- ergonomic black grip
- stainless steel
- blade 11 cm



## Ostrza do noży

- 2 rozmiary
- pakowane po 10 szt.

INDEKS INDEX

OSTRZE BLADE

PODZIAŁ PARTITION

EAN BARCODE

130-1199

9 mm

12 części pcs.



130-1198

18 mm

7 części pcs.



## Paper knife blades

Grand®

- two different sizes
- packaging 10 pcs.



## Noże do papieru

- plastikowa obudowa
- wysuwane, łamane ostrze
- blokada ostrza

## Paper knives

Grand®

- plastic cover
- retractable, divided blade
- blade blockade

### GR-120

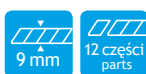

- wymiana ostrza przez zdjęcie czarnej końcówki
- do delikatnych prac

- blade replacement after removal of black handle
- for soft works



### GR-708

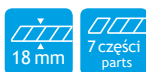

- karbowane brzozy zapewniają lepszy chwyt
- otwór do zawieszania
- wymiana ostrza przez zdjęcie czarnej końcówki
- do zwykłych prac

- corrugated edges for better grip
- hanging hole
- blade replacement after removal of black handle
- for standard works



INDEKS INDEX

SYMBOL SYMBOL

OSTRZE BLADE

PODZIAŁ PARTITION

UCHWYT GRIP

EAN BARCODE

130-1192

GR-120

9 mm

12 części pcs.

11 mm



130-1191

GR-708

18 mm

7 części pcs.

5 mm

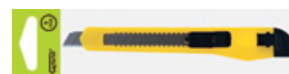

## Noże do papieru z prowadnicą

- obudowa ABS
- metalowa prowadnica
- karbowane brzożgi zapewniają lepszy chwyt
- otwór do zawieszania
- wysuwane, łamane ostrze

## Paper knives with slide

- ABS cover
- metal slide
- corrugated edges for better grip
- hanging hole
- retractable, divided blade



### GR-9951

- samoczynna blokada ostrza
- wymiana ostrza przez zdjęcie czarnej końcówki
- do standardowych prac



- automatic blade blockade
- blade replacement after removal of black handle
- for standard works

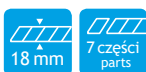

### GR-9988

- samoczynna blokada ostrza
- wymiana ostrza przez zdjęcie czarnej końcówki
- do cięższych prac



- automatic blade blockade
- blade replacement after removal of black handle
- for heavy works



### GR-64

- blokada ostrza w pokrętle
- wymiana ostrza po wysunięciu czarnej końcówki
- do cięższych prac



- blade blockade in knob
- blade replacement after removal of black handle
- for heavy works



INDEKS INDEX	SYMBOL SYMBOL	OSTRZE BLADE	PODZIAŁ PARTITION	UCHWYT GRIP	EAN BARCODE
130-1189	GR-9951	9 mm	12 części pcs.	9 mm	
130-1190	GR-9988	18 mm	7 części pcs.	18 mm	
130-1658	GR-64	18 mm	7 części pcs.	18 mm	

## Nóż do papieru GR-8100

- solidny nóż aluminiowy z rączką TPR (z gumy termoplastycznej)
- metalowa prowadnica
- karbowane brzożgi zapewniają lepszy chwyt
- otwór do zawieszania
- wysuwane, łamane ostrze
- samoczynna blokada ostrza
- wymiana ostrza po naciśnięciu czerwonego guziczka w uchwycie
- do cięższych prac

## Paper knife GR-8100

- solid knife made of aluminium with TPR handle (thermoplastic rubber)
- metal slide
- corrugated edges for better grip
- hanging hole
- retractable, divided blade
- automatic blade blockade
- blade replacement after pressing red button on grip
- for heavy works

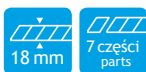

INDEKS INDEX	SYMBOL SYMBOL	OSTRZE BLADE	PODZIAŁ PARTITION	UCHWYT GRIP	EAN BARCODE
130-1657	GR-8100	18 mm	7 części pcs.	15 mm	



## Identyfikator GR-50

- przezroczyste PVC
- posiada klips oraz agrafkę
- sztywny kartonik do opisu
- wymiary: 90 x 55 mm
- pakowany po 50 szt.

INDEKS INDEX

EAN BARCODE

130-1063



## Name badge GR-50

- transparent PVC
- with clip and safety pin
- stiff name tag
- size: 90 x 55 mm
- packaging 50 pcs.

Grand®



## Identyfikator GR-50V

- identyfikator z plastikowym klipsem
- sztywny kartonik do opisu
- wymiary: 100 x 68 mm
- pakowany po 50 szt.

INDEKS INDEX

EAN BARCODE

130-1800



## Name badge with clip GR-50V

- stiff name tag
- size: 100 x 68 mm
- packaging 50 pcs.

Grand®



## Identyfikator GR-50T

- wymiary: 90x65 mm
- smycz 90 cm

## Name badge GR-50T

- size 90x65 mm
- with strap 90 cm long

Grand®



INDEKS INDEX

EAN BARCODE

130-1852





## Zwilżacz do palców glicerynowy K

- średnica wkładu 56 mm
- 20 gramów
- do liczenia pieniędzy, sortowania papierów



## Finger dumper glycerine K

- inset diameter 56 mm
- 20 g
- for counting money, sorting files

INDEKS INDEX

EAN BARCODE

140-1060



## Zwilżacze do palców z gąbką z gąbką

- do liczenia pieniędzy, sortowania papierów



## Finger dumpers with sponge

- for counting money, sorting files

INDEKS INDEX

SYMBOL SYMBOL

ŚREDNICA GĄBKİ SPONGE DIAMETER

EAN BARCODE

140-1058

005

44 mm



140-1057

006

68 mm



## Folia bąbelkowa

- wymiary: 2 m x 0,5 m



## Bubble wrap

- size: 2 m x 0,5 m

INDEKS INDEX

EAN BARCODE

130-1793



## Folia stretch

- 23 mic
- waga: 1,5 kg brutto
- naprężenie zrywające:
  - kierunek podłużny: 37,9 ± 1,9 MPa
  - kierunek poprzeczny: 19,0 ± 0,9 MPa
- wyprodukowano w Polsce

## Stretch foil

- 23 mic
- gross weight: 1,5 kg
- brakeaway tension:
  - longitudinal: 37,9 ± 1,9 MPa
  - transversal: 19,0 ± 0,9 MPa
- made in Poland



INDEKS INDEX

EAN BARCODE

130-1518



## Gumki recepturki

- elastyczne gumki
- dostępne w 4 kolorach: naturalnym, czerwonym, zielonym oraz białym
- pakowane w woreczki

## Rubber bands

- elastic rubber bands
- four colors available: natural, red, green, white
- packed in plastic bags



### 70% kauczuku

### 70% natural rubber

INDEKS INDEX	OPAK. PKG.	ROZMIAR SIZE	ŚREDNICA DIAMETER	DŁUGOŚĆ PO ZŁOŻENIU LENGTH WHEN FOLDED	EAN BARCODE
130-1062	25 g	miiks	miiks	miiks	5 903364 264550
130-1356	50 g	miiks	miiks	miiks	5 903364 264567
130-1038	1 kg	1,5 x 1,5 mm	25 mm	4 cm	5 903364 236038
130-1039	1 kg	1,5 x 1,5 mm	30 mm	5 cm	5 903364 236045
130-1040	1 kg	1,5 x 1,5 mm	40 mm	7 cm	5 903364 236052
130-1041	1 kg	1,5 x 1,5 mm	50 mm	8 cm	5 903364 236069
130-1042	1 kg	1,5 x 2,5 mm	50 mm	8 cm	5 903364 236076
130-1043	1 kg	1,5 x 1,5 mm	60 mm	9 cm	5 903364 236083
130-1044	1 kg	1,5 x 1,5 mm	75 mm	13 cm	5 903364 236656
130-1036	1 kg	1,5 x 1,5 mm	100 mm	16 cm	5 903364 236663
130-1037	1 kg	1,5 x 1,5 mm	140 mm	22 cm	5 903364 236670

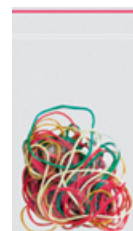

### 60% kauczuku

### 60% natural rubber

INDEKS INDEX	OPAK. PKG.	ROZMIAR SIZE	ŚREDNICA DIAMETER	DŁUGOŚĆ PO ZŁOŻENIU LENGTH WHEN FOLDED	EAN BARCODE
130-1676	1 kg	1,5 x 1,5 mm	25 mm	4 cm	5 903364 263010
130-1677	1 kg	1,5 x 1,5 mm	30 mm	5 cm	5 903364 263027
130-1678	1 kg	1,5 x 1,5 mm	40 mm	7 cm	5 903364 263034
130-1679	1 kg	1,5 x 1,5 mm	50 mm	8 cm	5 903364 263041
130-1680	1 kg	1,5 x 2,5 mm	50 mm	8 cm	5 903364 263058
130-1681	1 kg	1,5 x 1,5 mm	60 mm	9 cm	5 903364 263065
130-1682	1 kg	1,5 x 1,5 mm	75 mm	13 cm	5 903364 263072
130-1683	1 kg	1,5 x 1,5 mm	100 mm	16 cm	5 903364 263089
130-1684	1 kg	1,5 x 1,5 mm	140 mm	22 cm	5 903364 263096



## Gumki recepturki w kulce

- 170 kolorowych gumek złożonych w kulkę
- rozmiar gumek: 70x3x1,1 mm
- waga kulki: 105 g

## Rubber band ball

- 170 color rubber bands assembled in a ball
- band size: 70x3x1,1 mm
- ball weight: 105 g



INDEKS INDEX	WAGA WEIGHT	OPAK. PKG.	EAN BARCODE
130-1632	105 g	170 szt. pcs.	5 903364 257491

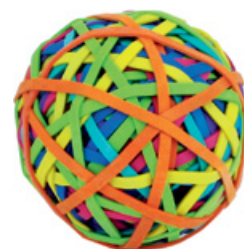





## Numeratory TY102

- numeratory automatyczne
- metalowa konstrukcja
- ergonomiczny uchwyt
- wysokość czcionki 4,5 mm
- wkład samotuszujący



000006

0000007

00000008

000000000012

INDEKS INDEX	SYMBOL SYMBOL	OPIS TYPE	EAN BARCODE
140-1009	TY102-6	6-cyfrowy 6-digit	
140-1010	TY102-7	7-cyfrowy 7-digit	
140-1011	TY102-8	8-cyfrowy 8-digit	
140-1059	TY102-12	12-cyfrowy 12-digit	

## Numbering machines TY102

- automatic numbering machines
- metal mechanism
- ergonomic handle
- font size 4,5 mm
- self-inking pad



## TooR



## Wkład do datownika 4610

- wymienne wkłady w plastikowej obudowie
- kolor tuszu: czarny
- wymiary: 33x23 mm

## Date stamp refill 4610

- replaceable refills in plastic cover
- black ink
- size: 33x23 mm

INDEKS INDEX	EAN BARCODE
140-1046	



## Datowniki 4510

- samotuszujące
- obudowa z tworzywa sztucznego pokryta materiałem antypoślizgowym
- wysokość czcionki 4 mm
- wersja literowo-cyfrowa posiada polskie nazwy miesięcy

## Daters 4510

- self-inking
- plastic cover coated with non-slip material
- font size 4 mm
- literal & numerical with Polish month names



25 11 2020

25 LIS 2020

INDEKS INDEX	SYMBOL SYMBOL	TYP TYPE	EAN BARCODE
140-1064	GR-4510C	cyfrowy numerical	
140-1065	GR-4510L	literowo-cyfrowy literal & numerical	





## Tusz do pieczętek i stempli

- wysokiej jakości tusz
- szybkoschnący, nie przesiąka przez papier
- pozostawia długotrwałe, wyraźne pieczętki
- butelka z trwałego tworzywa z aplikatorem
- nakrętka butelki w kolorze tuszu

## Stamp ink

- high quality ink
- quick-drying, no soaking through paper
- long-lasting, clear stamps
- bottle made of durable material with applicator
- bottle cap in ink color

**Horse**

INDEKS INDEX	KOLOR COLOR	EAN BARCODE
140-1048	● czarny black	 8 851552 509020
140-1049	● czerwony red	 8 851552 509037
140-1052	● niebieski blue	 8 851552 509013
140-1050	● fioletowy violet	 8 851552 509075
140-1053	● zielony green	 8 851552 509044

28 ml



## Poduszki do pieczętek i stempli

- estetyczne, wysokiej jakości pudełka z metalową pokrywą
- wewnątrz wkład nasączony lub nienasączony tuszem

## Stamp pads

- esthetic, high quality boxes with metal lid
- inner pad soaked with ink or dry

**Horse**



KOLOR COLOR	Nr 1 No 1 150 x 74 mm	Nr 2 No 2 110 x 70 mm	Nr 3 No 3 85 x 54 mm
● czarny black	140-1015  8 851552 502021	140-1020  8 851552 503028	140-1025  8 851552 504025
● czerwony red	140-1016  8 851552 502038	140-1021  8 851552 503035	140-1026  8 851552 504032
● niebieski blue	140-1018  8 851552 502014	140-1023  8 851552 503011	140-1028  8 851552 504018
● fioletowy violet	140-1017  8 851552 502076	140-1022  8 851552 503073	140-1027  8 851552 504070
● zielony green	140-1019  8 851552 502045	140-1024  8 851552 503042	140-1029  8 851552 504049
○ nienasączone dry	140-1032  8 851552 502007	140-1033  8 851552 503004	140-1034  8 851552 504001



## Temperówki automatyczne

- na baterie typu AA (4 szt., nie dołączono)
- stabilna podstawa

## Automatic sharpeners

- for AA batteries (4 pcs., not included)
- stable base



### Dynamic E5121

- elegancka czarna temperówka automatyczna
- mechanizm ślimakowy z nierdzewnej stali
- do ostrzenia ołówków i kredek 6,5–8 mm

### Dynamic E5121

- elegant black automatic sharpener
- stainless steel helical cutting blade
- for pencil diameter 6,5–8 mm



INDEKS INDEX

EAN BARCODE

130-1669



### EG-5146

- mechanizm ślimakowy z nierdzewnej stali
- łatwy do opróżniania pojemnik na ścinki
- przeznaczona do drewnianych ołówków i kredek 6,5–8 mm

### EG-5146

- stainless steel helical cutting blade
- trash tray easy to clean
- for wooden pencils 6,5–8 mm



INDEKS INDEX

KOLOR COLOR

EAN BARCODE



130-1802

● niebiesko-biały blue&white



130-1803

● niebiesko-czarny blue&black



### EG-5161USB

- dwuotworowa, do ołówków o średnicy 6–8 i 9–12 mm
- bezpieczny dla dzieci przełącznik rozmiaru ołówka
- trwały mechanizm z dwoma wysokiej jakości ostrzami ze stali węglowej
- ostrza wymienne
- 2 dodatkowe ostrza
- możliwość ładowania kablem ze złączem USB (w zestawie)

### EG-5161USB

- double-hole, for pencil sizes 6–8 and 9–12 mm
- micro-switch lock safe for children
- durable mechanism with 2 high quality carbon steel sharpener blades
- replaceable blades
- 2 additional blades
- possible to charge with USB wire (included)



INDEKS INDEX

KOLOR COLOR

EAN BARCODE

130-1851

● czarny black



### Ostrza do temperówki EG-5161USB

### Blades for EG-5161USB sharpener



INDEKS INDEX

ZESTAW SET

EAN BARCODE

130-1908

2 małe, 1 duże 2 small, 1 large





## Alpha

- do ostrzenia ołówków i kredek
- wymiary: 133x79x90 mm

- for pencils
- dimensions: 133x79x90 mm

## M5033B

- mechanizm: tradycyjny
- mechanism: traditional (blades)

INDEKS INDEX	KOLOR COLOR	EAN BARCODE
130-1313	● czarny black	
* 130-1314	● czerwony red	
130-1315	● niebieski blue	

\* do wyczerpania zapasów while stock lasts

## Temperówka na korbkę

- do ostrzenia ołówków i kredek
- mechanizm ślimakowy
- metalowa obudowa
- wysuwany transparentny pojemnik na ścinki
- antypoślizgowy spód
- możliwość przymocowania do blatu stołu

INDEKS INDEX	SYMBOL SYMBOL	EAN BARCODE
130-1863	GR-5000	

## Temperówki metalowe

- temperówki kostki
- hartowane, nierdzewne ostrza

INDEKS INDEX	SYMBOL SYMBOL	TYP TYPE
130-1311	GR-626	pojedyncza single hole
130-1312	GR-627	podwójna double hole

## Temperówka plastikowa

- nierdzewne ostrze
- miks kolorów
- pakowana: 1 szt. (zawieszka)



INDEKS INDEX	SYMBOL SYMBOL	ŚREDNICA DIAMETER	EAN BARCODE
130-1557	GR-641	8 mm	

EAGLE



## M5034B

- mechanizm: ślimakowy z nierdzewnej stali
- mechanism: stainless steel helical cutting blade

INDEKS INDEX	KOLOR COLOR	EAN BARCODE
130-1599	● czarny black	
130-1600	● czerwony red	
130-1601	● niebieski blue	



3  
lata  
years

## Hand-cranked planetary sharpener

- for pencils
- steel alloy cutter
- metal casing
- sliding trash tray
- non-slip base
- possible to fix sharpener to countertop

fiorelo



## Metal sharpeners

- cube sharpeners
- tempered, stainless blade

Grand



## Plastic sharpener

- stainless blade
- assorted colors
- packaging: 1 pc. (plastic bag with eurohole)

fiorelo





## Temperówki z pojemnikiem

- plastikowe, w różnych kolorach

## Sharpeners with container

- plastic, assorted colors



GR-223



GR-224



GR-862-3



GR-922-2



GR-859-1

### pojedyncze

### single hole

INDEKS INDEX	SYMBOL SYMBOL	KSZTAŁT SHAPE	EAN BARCODE
130-1613	GR-223	stożek taper	

### podwójne

### double hole

INDEKS INDEX	SYMBOL SYMBOL	KSZTAŁT SHAPE	EAN BARCODE
130-1614	GR-224	stożek taper	
130-1807	GR-859-1	owalna oval	
130-1808	GR-862-3	zamykana with closure	
130-1809	GR-922-2	trójkątna triangle	



## Temperówki z gumką

- temperówki pojedyncze
- gumka z zatyczką

## Sharpener + eraser

- single hole sharpener
- eraser with cap



GR-F460



GR-F445



INDEKS INDEX	SYMBOL SYMBOL	EAN BARCODE
130-1818	GR-F445	
130-1819	GR-F460	



## Gumki do wymazywania

- miękkie, ścierające się gumki wykonane z TPR (gumy termoplastycznej)
- do ołówków i grafitów
- do stosowania na różnych powierzchniach
- nie zawierają PVC

## Erasers

- soft erasers, abrasive, made of TPR (thermoplastic rubber)
- for pencils and graphites
- for various surfaces
- contain no PVC



GR-320



GR-345



GR-336









GR-360



INDEKS INDEX	SYMBOL SYMBOL	ROZMIAR SIZE	OPAK. PKG.	EAN BARCODE
160-2194	GR-320	57x21x10 mm	20 szt. pcs.	
160-1926	GR-345	40x20x10 mm	45 szt. pcs.	
160-2195	GR-336	40x16x10 mm	36 szt. pcs.	
160-1927	GR-360	30x15x6 mm	60 szt. pcs.	

## Gumki do wymazywania

- stoik 100 szt.

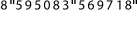
INDEKS INDEX	KSZTAŁT SHAPE	ROZMIAR SIZE	EAN BARCODE
160-2234	sówka owl	34x23x5 mm	
160-2235	panda panda	32x30x5 mm	
160-2236	dżdżownica caterpillar	41x26x5 mm	
160-2250	małpka monkey	25x28x5 mm	
160-2238	wóz strażacki fire truck	38x22x5 mm	
160-2249	serce heart	30x30x5 mm	
160-2248	piłka ball	Ø 20 x 7 mm	

## Erasers



- jar 100 pcs.

**! wygodny stoik na ladę**  
jar useful on the counter



## Gumki do wymazywania ARK

- w kształcie kredki
- stoik 25 szt.

INDEKS INDEX	KOLORY COLORS	ROZMIAR SIZE	EAN BARCODE
160-2251	pastel pastel	62x10 mm	
160-2252	neon neon	62x10 mm	

## Erasers ARK

- crayon-shaped
- jar 25 pcs.

**! wygodny stoik na ladę**  
jar useful on the counter



## Uchwyt na ołówek GR-F3U

- ułatwia naukę właściwego trzymania ołówka
- termoplastyczna guma
- miks kolorów
- pakowany po 3 sztuki w woreczku

## Pencil grip GR-F3U

- for practicing proper pencil holding
- thermoplastic rubber
- assorted colors
- 3 pcs. in bag



INDEKS INDEX	EAN BARCODE
160-2102	





## Flet prosty

- wykonany z trwałego tworzywa ABS w kolorze kości słoniowej lub z lakierowanego drewna
- w zestawie przyrząd do czyszczenia
- pakowany w etui z tworzywa

## Flute

- made of durable ABS material or of lacquered wood
- cleaning device included
- packed in plastic bag



INDEKS INDEX	RODZAJ TYPE	EAN BARCODE
130-1649	plastikowy plastic	5 903364 258016
130-1661	drewniany wooden	5 903364 258115



## Gwizdek GR-912

- metalowy, niklowany
- z kulką
- nadaje się do grawerowania
- szerokość ustnika 15 mm

## Whistle GR-912

- metal, nickelplated
- ball inside
- suitable for engraving
- mouthpiece width 15 mm



INDEKS INDEX	EAN BARCODE
130-1712	5 903364 258955



## Szkoło powiększające

- obudowa z czarnego tworzywa sztucznego
- soczewka plastikowa dwuogniskowa

## Magnifying glass

- cover made of black material
- plastic bifocal glass, double magnification



INDEKS INDEX	ŚREDNICA DIAMETER	POWIĘKSZENIE MAGNIFICATION	EAN BARCODE
120-1417	50 mm	x3, x5	5 903364 247393
120-1351	75 mm	x2,5, x5	5 903364 247416

## Liczydło plastikowe 150

- wykonane z tworzywa sztucznego
- stabilna podstawa
- szerokość 142 mm, wysokość 155 mm

INDEKS INDEX

130-1854

EAN BARCODE



## Plastic abacus 150

- made of durable material
- stable folding base
- 142 mm wide, 155 mm high



## Liczydło drewniane GR-1182

- drewniane liczydło ze stabilną, składaną podstawą
- zawiera 100 kolorowych koralików (10x10)
- pomocne w nauce liczenia – nie tylko dodawania i odejmowania, ale też mnożenia, dzielenia, pierwiastkowania i innych operacji matematycznych
- szerokość 200 mm, wysokość 260 mm

INDEKS INDEX

130-1673

EAN BARCODE



## Wooden abacus GR-1182

- wooden abacus with stable folding base
- contains 100 color beads (10x10)
- useful in learning counting: addition, subtraction, multiplication, division and other mathematic calculations
- 200 mm wide, 260 mm high



## Patyczki do liczenia

- wykonane z tworzywa sztucznego
- przekrój kwadratowy

INDEKS INDEX

130-1493

OPAK. PKG.

100 szt. pcs.

EAN BARCODE



## Counting rods

- made of durable material
- square cross-section







## Kreda chodnikowa GR-F15-7

- grube pałeczki o przekroju okrągłym
- średnica 2–2,5 cm
- długość min. 10,5 cm
- 15 sztuk w opakowaniu
- plastikowe wiaderko z uchwytem
- kolory: biały, żółty, czerwony, niebieski, zielony, brązowy, liliowy



## Sidewalk chalk GR-F15-7

- thick rods with round cross-section
- diameter 2–2,5 cm
- length min. 10,5 cm
- 15 pieces in a box
- plastic bucket with handle
- colors: white, yellow, red, blue, green, brown, lilac



INDEKS INDEX

170-2295

EAN BARCODE



## Kreda biała

- biała, okrągła w przekroju kreda
- kreda tradycyjna: stożkowy kształt ułatwia trzymanie
- kreda bezpyłowa: nie wytwarza pyłu w trakcie pisania po tablicy



INDEKS INDEX

170-2128

TYP TYPE

tradycyjna traditional

DŁUGOŚĆ LENGTH

82 mm

OPAK. PKG.

12 szt. pcs.

EAN BARCODE



## White chalk

- white chalk, rounded cross-section
- traditional chalk: conical shape for easy grip
- dustless chalk: no dust while writing



## Kreda kolorowa

- okrągła w przekroju kreda kolorowa
- stożkowy kształt ułatwia trzymanie



INDEKS INDEX

170-2135

TYP TYPE

tradycyjna traditional

DŁUGOŚĆ LENGTH

82 mm

OPAK. PKG.

12 szt., 6 kol.  
12 pcs., 6 col.

EAN BARCODE



## Color chalk

- color chalk, rounded cross-section
- conical shape for easy grip

## Zestaw Redis 175

- obsadka
- 3 stalówki: 1,5 mm, 2,5 mm, 3,5 mm

### Redis set 175

- pen holder
- 3 nibs: 1,5 mm, 2,5 mm, 3,5 mm

INDEKS INDEX

EAN BARCODE

130-1511



Grand®



## Grafioty do cyrkli

- wysokiej jakości
- pakowane po 5 szt. w przezroczystych fiolkach
- opakowanie zbiorcze: 30 fiolek na blistrze

### Compass graphites

- high quality
- packed in sets of 5 pcs. in transparent vials
- inner box: 30 vials on blister card

INDEKS INDEX

EAN BARCODE

130-1035



Grand®



## Cyrkiel 248T

- plastikowa konstrukcja
- regulowany uchwyt na ołówek
- fluorescencyjne kolory
- pakowany w woreczek z zawieszka

### Compass 248T

- construction made of plastic
- adjustable pencil holder
- fluorescent colors
- packed in plastic bag with eurohole



INDEKS INDEX

EAN BARCODE

130-1522



## Cyrkiel GR-C100

- metalowa konstrukcja
- regulowany uchwyt na ołówek
- długość cyrkla: 105 mm

### Compass GR-C100

- metal construction
- adjustable pencil holder
- compass length: 105 mm

INDEKS INDEX

EAN BARCODE

130-1547



Grand®



## Cyrkiel GR-C100P

- plastikowa konstrukcja
- regulowany uchwyt na ołówek
- pakowany w zawieszka
- długość cyrkla 120 mm

### Compass GR-C100P

- plastic construction
- adjustable pencil holder
- packed in plastic bag with eurohole
- compass length 120 mm

INDEKS INDEX

EAN BARCODE

\* 130-1783



\* do wyczerpania zapasów while stock lasts

fiorello®



## Cyrkiel GR-C106

- metalowa konstrukcja
- w zestawie wymienny grafit
- długość cyrkla 125 mm
- pastelowe kolory

### Compass GR-C106

- metal construction
- spare graphite included
- compass length 125 mm
- pastel colors

INDEKS INDEX

EAN BARCODE

130-1902



Grand®





### Cyrkiel GR-C110

- długość cyrkiła 115 mm
- pojedynczo pakowany w foliowe etui
- opak. zbiorcze 10 szt.

### Compass GR-C110

- compass length 115 mm
- packed in plastic bag with eurohole
- inner box: 10 pcs.

INDEKS INDEX

EAN BARCODE

130-1652



### Cyrkiel GR-C102A

- metalowa konstrukcja
- w zestawie wymienny grafit
- długość cyrkiła 145 mm

### Compass GR-C102A

- metal construction
- spare graphite included
- compass length 145 mm

INDEKS INDEX

EAN BARCODE

130-1804



### Cyrkiel GR-C102

- metalowa konstrukcja
- regulowany uchwyt na grafit
- w zestawie wymienny grafit
- długość cyrkiła 121 mm

### Compass GR-C102

- metal construction
- adjustable graphite holder
- spare graphite included
- compass length 121 mm

INDEKS INDEX

EAN BARCODE

130-1782



### Cyrkiel GR-C112

- pakowany w etui
- długość cyrkiła 121 mm

### Compass GR-C112

- packed in plastic case
- compass length 121 mm

INDEKS INDEX

OPAK. PKG.

EAN BARCODE

130-1653

12 szt. pcs.



## Cyrkiel GR-C103

- metalowa konstrukcja
- w zestawie wymienny grafit i temperówka do grafitu
- długość cyrkla 115 mm

INDEKS INDEX

130-1544

EAN BARCODE



## Compass GR-C103

- metal construction
- spare graphite and graphite sharpener included
- compass length 115 mm



## Zerownik GR-Z102

- metalowa konstrukcja
- regulowany uchwyt na grafit
- w zestawie wymienny grafit
- długość: 110 mm

INDEKS INDEX

130-1546

EAN BARCODE



## Compass GR-Z102

- metal construction
- adjustable graphite holder
- spare graphite included
- compass length: 110 mm



## Cyrkle GR-C105A / GR-C105B

- metalowa konstrukcja
- regulowany uchwyt na grafit
- w zestawie wymienny grafit
- długość cyrkla 136 mm

INDEKS INDEX SYMBOL SYMBOL

130-1319

GR-C105A



130-1320

GR-C105B



EAN BARCODE

## Compasses GR-C105A / GR-C105B

- metal construction
- adjustable graphite holder
- spare graphite included
- compass length 136 mm



GR-C105A



GR-C105B

## Cyrkle GR-C101 / GR-C201

- metalowa konstrukcja
- regulowany uchwyt na grafit

INDEKS INDEX SYMBOL SYMBOL

130-1654

GR-C101

DŁUGOŚĆ LENGTH 140 mm



130-1655

GR-C201

155 mm



EAN BARCODE

## Compasses GR-C101 / GR-C201

- metal construction
- adjustable graphite holder



GR-C101



GR-C201



### GR-C204

- 4 elementy w zestawie: cyrkiel mikrometryczny 172 mm z mechanizmem śrubowym (oba ramiona łamane), końcówka cyrkiela z uchwytem uniwersalnym, zapasowy grafit, przedłużacz

### GR-C204

- contains 4 elements: micrometric compass 172 mm (both arms folding), compass ending with universal holder, spare graphite, extender

INDEKS INDEX

EAN BARCODE

130-1656



### GR-C205

- 5 elementów w zestawie: cyrkiel 136 mm, zerownik, końcówka cyrkiela z uchwytem uniwersalnym, przedłużacz, wymienny grafit

### GR-C205

- contains 5 elements: compass 136 mm, compass, compass ending with universal holder, spare graphite, extender

INDEKS INDEX

EAN BARCODE

130-1552



### GR-C209

- 9 elementów w zestawie: cyrkiel 140 mm, zerownik, przenośnik, grafion, uchwyt grafionu, zapasowy grafion, zapasowa szpilka, przedłużacz, zapasowy grafit z uchwytem

### GR-C209

- contains 9 elements: compass 140 mm, compass, carrier, drawing pen, drawing pen holder, spare drawing pen, spare pin, extender, spare graphite with holder

INDEKS INDEX

EAN BARCODE

130-1553



## Zestaw krzywków GR-869

- zawiera 3 elementy
- transparentne, brązowe przyrządy z polistyrenu

## Burmester set GR-869

- contains 3 elements
- transparent, brown color, made of polystyrene

Grand®

INDEKS INDEX

130-1507

EAN BARCODE



## Kątomierz GR-840

- skala do 180°
- linijka 10 cm
- transparentny
- wykonany z polistyrenu

## Protractor GR-840

- scale up to 180°
- ruler 10 cm
- transparent
- made of polystyrene

Grand®

INDEKS INDEX

130-1503

EAN BARCODE



## Ekierka

- transparentna
- wykonana z polistyrenu

## Triangle

- transparent
- made of polystyrene

Grand®



INDEKS INDEX	SYMBOL SYMBOL	KOLOR COLOR	KĄT ANGLE	DŁUGOŚĆ LENGTH	EAN BARCODE
130-1501	GR-854	dymne transparent, brown	45°	9,5 cm	5 903364 246402
130-1502	GR-853	dymne transparent, brown	60°	13,5 cm	5 903364 246426
130-1709	GR-854T	transparentne transparent	45°	9,5 cm	5 903364 258894
130-1710	GR-853T	transparentne transparent	60°	13,5 cm	5 903364 258917

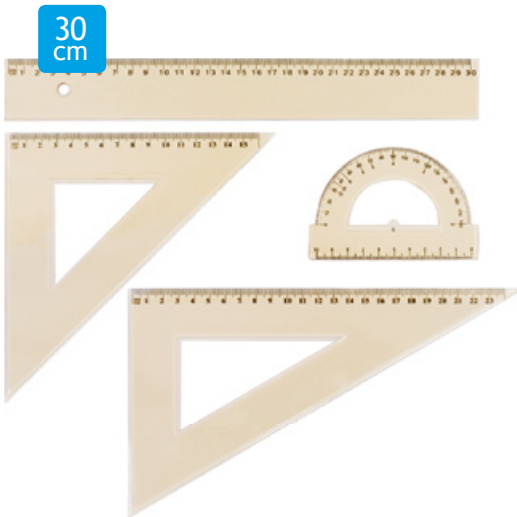

**GR-868**

- zawiera 4 elementy: linijka 30 cm, ekierka 16 cm, ekierka 24 cm, kątomierz 10 cm
- transparentne, brązowe przyrządy z polistyrenu



**GR-868**

- contains 4 elements: ruler 30 cm, triangle 16 cm, triangle 24 cm, protractor 10 cm
- transparent, brown color, made of polystyrene

INDEKS INDEX

EAN BARCODE

130-1026



**GR-032 / GR-032T**

- zawiera 4 elementy: linijka 20 cm, ekierka 9,5 cm, ekierka 13,5 cm, kątomierz 10 cm
- wykonane z polistyrenu



**GR-032 / GR-032T**

- contains 4 elements: ruler 20 cm, triangle 9,5 cm, triangle 13,5 cm, protractor 10 cm
- made of polystyrene

INDEKS INDEX SYMBOL SYMBOL KOLOR COLOR

EAN BARCODE

130-1024

GR-032

kolorowe brokatowe color, with glitter



130-1602

GR-032T

transparentne transparent

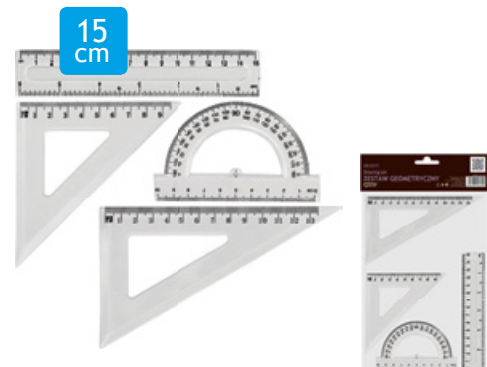

**GR-031T**

- zawiera 4 elementy: linijka 15 cm, ekierka 9,5 cm, ekierka 13,5 cm, kątomierz 10 cm
- transparentne przyrządy z polistyrenu



**GR-031T**

- contains 4 elements: ruler 15 cm, triangle 9,5 cm, triangle 13,5 cm, protractor 10 cm
- transparent, made of polystyrene

INDEKS INDEX

EAN BARCODE

130-1640



## Linijki drewniane

- linijki drewniane w zabawnych kształtach
- skala w cm wraz z oznaczeniami pomocniczymi mm
- mogą służyć też jako szablon do odrysowania kształtu
- grubość 3 mm

## Wooden rulers

- funny shapes
- cm scale with additional mm marks
- can be used as template to draw the shapes
- 3 mm thick

INDEKS INDEX	SYMBOL SYMBOL	RODZAJ TYPE	POMIAR MEASUREMENT	EAN BARCODE
130-1904	GR-F67JR	jednorożec unicorn	12 cm	
130-1881	GR-F88KC	● kot czarny black cat	15 cm	
130-1882	GR-F87KR	● kot różowy pink cat	15 cm	
130-1905	GR-F77LP	łapa paw	15 cm	
130-1906	GR-F37MW	miś wieszak bear hanger	15 cm	
130-1907	GR-F47MM	miś miarka bear scale	15 cm	





## Elastyczne przybory geometryczne

- elastyczne, giętkie tworzywo
- zaokrąglone brzegi
- dobrze przylegają do powierzchni



## Flexible drawing utensils

- flexible and pliable
- round edges
- stick to the surface well

## Linijki elastyczne

- neonowe kolory: zielony, niebieski
- dostępne długości: 15, 20 cm

## Flexible rulers

- neon colors: green, blue
- available sizes: 15, 20 cm



INDEKS INDEX	SYMBOL SYMBOL	DŁUGOŚĆ LENGTH	EAN BARCODE
130-1812	GR-F150	15 cm	
130-1813	GR-F200	20 cm	

## Zestaw geometryczny elastyczny GR-F158

- zawiera 3 elementy: linijka 20 cm, ekiemka 14 cm, kątomierz 10 cm

## Flexible drawing set GR-031T

- contains 3 elements: ruler 20 cm, triangle 14 cm, protractor 10 cm

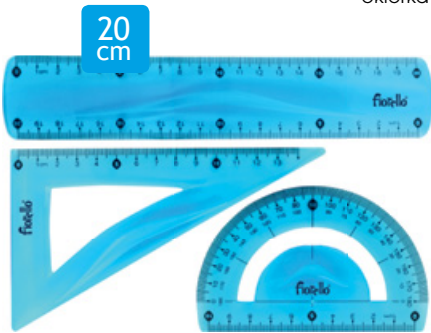

INDEKS INDEX	EAN BARCODE
130-1820	

## Linijka skalówka trójkątna budowlana

- wykonana z tworzywa sztucznego w kolorze białym
- trójkątny przekrój
- kolorowe oznaczenie każdej ze stron
- 6 precyzyjnych skali: 100/200/250/300/400/500

## Triangular engineering scale ruler

- made of white plastic
- triangular cross-section
- colored mark on every side
- 6 precise scales: 100/200/250/300/400/500

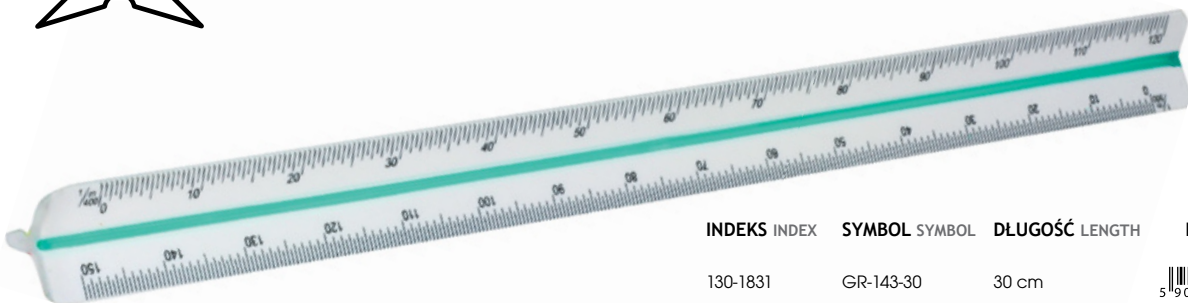

INDEKS INDEX	SYMBOL SYMBOL	DŁUGOŚĆ LENGTH	EAN BARCODE
130-1831	GR-143-30	30 cm	

## Linijki aluminiowe

- wytrzymałe aluminium
- opakowanie jednostkowe z zawieszka

## Aluminium rulers

- durable aluminium
- single plastic bag with hanger

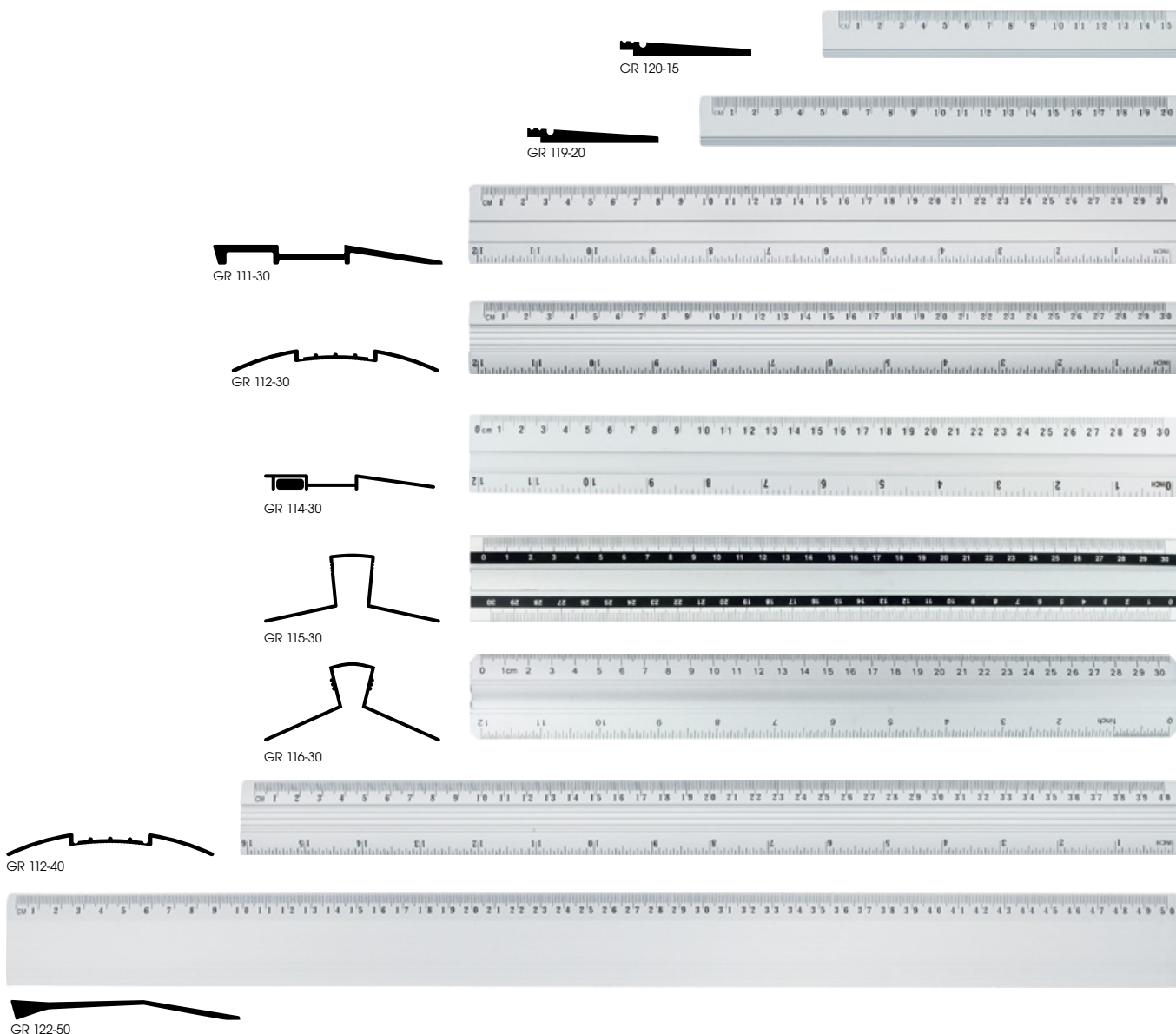

INDEKS INDEX	SYMBOL SYMBOL	DŁUGOŚĆ LENGTH	OPIS TYPE	EAN BARCODE
130-1707	GR 120-15	15 cm	cm cm	
130-1504	GR 119-20	20 cm	cm cm	
130-1323	GR 111-30	30 cm	cm / cale cm / inch	
130-1322	GR 112-30	30 cm	cm / cale cm / inch	
★ 130-1828	GR 114-30	30 cm	podgumowana, cm / cale with rubber, cm / inch	
★ 130-1829	GR 115-30	30 cm	z uchwytem, cm with handle, cm	
★ 130-1830	GR 116-30	30 cm	z uchwytem, cm / cale with handle, cm / inch	
130-1505	GR 112-40	40 cm	cm / cale cm / inch	
130-1506	GR 122-50	50 cm	cm cm	



★ do wyczerpania zapasów while stock lasts

## Linijki przezroczyste

- wytrzymałe, sprężyste, wykonane z polistyrenu
- linijki pakowane pojedynczo w zawieszki

## Transparent rulers

- durable, resilient, made of polystyrene
- packed in plastic bag with eurohole

GR-801



GR-896



GR-820



GR-878



GR-831



GR-855



INDEKS	INDEX	SYMBOL	SYMBOL	DŁUGOŚĆ	LENGTH	OPIS	TYPE	EAN	BARCODE
130-1593		GR-801		15 cm				5 903364 230845	
130-1496		GR-896		20 cm				5 903364 246365	
130-1497		GR-820		30 cm				5 903364 246327	
130-1498		GR-878		30 cm		z uchwytem	with handle	5 903364 246204	
130-1577		GR-831		40 cm				5 903364 230883	
130-1499		GR-855		50 cm				5 903364 246341	

**paper papiernicze**

## ETYKIETY samoprzylepne białe

- uniwersalne: do drukarek atramentowych, laserowych i kserokopiarek
- arkusze formatu A4
- 34 różne rozmiary
- opak. 100 arkuszy

## White adhesive stickers

- multi-purpose: for ink jet, laser jet and copiers
- A4 sheets
- 34 different sizes
- box of 100 sheets

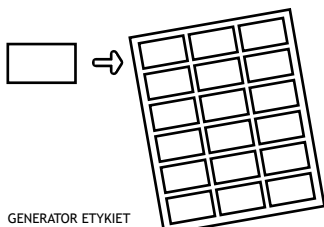

GENERATOR ETYKIET  
STICKERS GENERATOR  
www.generator-etykiet.kwtrade.pl



A4 100

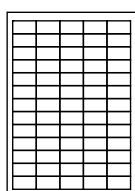

- 38x21,2 mm
- 65 etykiet/ark.
- 38x21,2 mm
- 65 stickers/sheet
- No. 001

150-1028

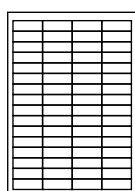

- 48,5x16,9 mm
- 64 etykiet/ark.
- 48,5x16,9 mm
- 64 stickers/sheet
- No. 002

150-1029

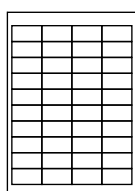

- 48,5x25,4 mm
- 40 etykiet/ark.
- 48,5x25,4 mm
- 40 stickers/sheet
- No. 003

150-1030

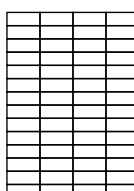

- 52,5x21,2 mm
- 56 etykiet/ark.
- 52,5x21,2 mm
- 56 stickers/sheet
- No. 004

150-1031

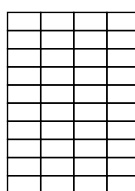

- 52,5x29,6 mm
- 40 etykiet/ark.
- 52,5x29,6 mm
- 40 stickers/sheet
- No. 005

150-1032

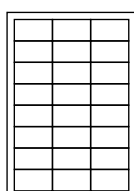

- 64,6x33,8 mm
- 24 etykiet/ark.
- 64,6x33,8 mm
- 24 stickers/sheet
- No. 006

150-1033

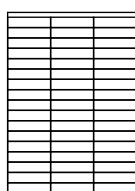

- 70x16,9 mm
- 51 etykiet/ark.
- 70x16,9 mm
- 51 stickers/sheet
- No. 007

150-1034

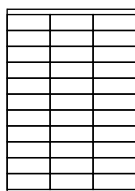

- 70x25,4 mm
- 33 etykiet/ark.
- 70x25,4 mm
- 33 stickers/sheet
- No. 008

150-1309

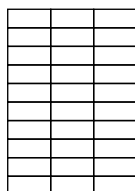

- 70x29,7 mm
- 30 etykiet/ark.
- 70x29,7 mm
- 30 stickers/sheet
- No. 009

150-1036

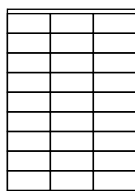

- 70x32 mm
- 27 etykiet/ark.
- 70x32 mm
- 27 stickers/sheet
- No. 010

150-1037

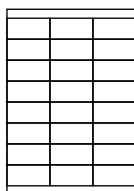

- 70x33,8 mm
- 24 etykiet/ark.
- 70x33,8 mm
- 24 stickers/sheet
- No. 011

150-1038

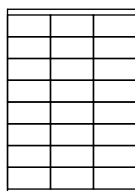

- 70x35 mm
- 24 etykiet/ark.
- 70x35 mm
- 24 stickers/sheet
- No. 012

150-1039

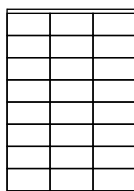

- 70x36 mm
- 24 etykiet/ark.
- 70x36 mm
- 24 stickers/sheet
- No. 013

150-1040

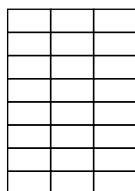

- 70x37 mm
- 24 etykiet/ark.
- 70x37 mm
- 24 stickers/sheet
- No. 014

150-1041

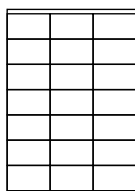

- 70x41 mm
- 21 etykiet/ark.
- 70x41 mm
- 21 stickers/sheet
- No. 015

150-1042

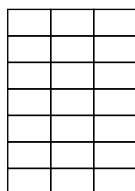

- 70x42,3 mm
- 21 etykiet/ark.
- 70x42,3 mm
- 21 stickers/sheet
- No. 016

150-1043

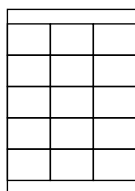

- 70x50,8 mm
- 15 etykiet/ark.
- 70x50,8 mm
- 15 stickers/sheet
- No. 017

150-1044

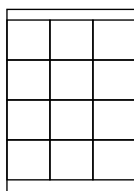

- 70x67,7 mm
- 12 etykiet/ark.
- 70x67,7 mm
- 12 stickers/sheet
- No. 018

150-1045

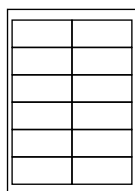

- 97x42,3 mm
- 12 etykiet/ark.
- 97x42,3 mm
- 12 stickers/sheet
- No. 019

150-1046

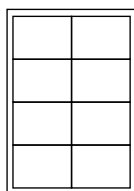

- 97x67,7 mm
- 8 etykiet/ark.
- 97x67,7 mm
- 8 stickers/sheet
- No. 020

150-1310

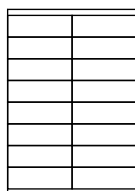

- 105x33,8 mm
- 16 etykiet/ark.
- 105x33,8 mm
- 16 stickers/sheet
- No. 021

150-1048



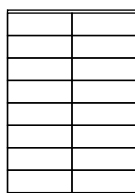

- 105x35 mm
- 16 etykiet/ark.
- 105x35 mm
- 16 stickers/sheet
- No. 022

150-1049

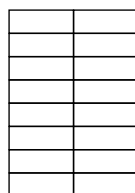

- 105x37 mm
- 16 etykiet/ark.
- 105x37 mm
- 16 stickers/sheet
- No. 023

150-1050

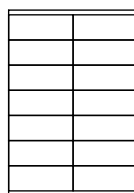

- 105x41 mm
- 14 etykiet/ark.
- 105x41 mm
- 14 stickers/sheet
- No. 024

150-1051

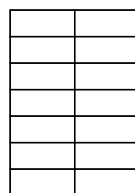

- 105x42,3 mm
- 14 etykiet/ark.
- 105x42,3 mm
- 14 stickers/sheet
- No. 025

150-1052

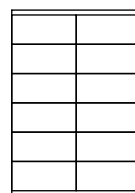

- 105x48 mm
- 12 etykiet/ark.
- 105x48 mm
- 12 stickers/sheet
- No. 026

150-1053

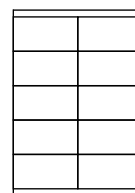

- 105x57 mm
- 10 etykiet/ark.
- 105x57 mm
- 10 stickers/sheet
- No. 027

150-1054

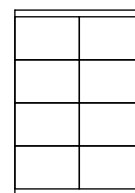

- 105x70 mm
- 8 etykiet/ark.
- 105x70 mm
- 8 stickers/sheet
- No. 028

150-1311

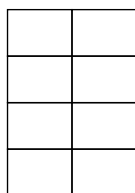

- 105x74 mm
- 8 etykiet/ark.
- 105x74 mm
- 8 stickers/sheet
- No. 029

150-1056



- 105x148 mm
- 4 etykiety/ark.
- 105x148 mm
- 4 stickers/sheet
- No. 030

150-1057

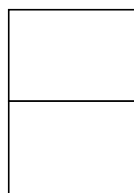

- 210x148 mm
- 2 etykiety/ark.
- 210x148 mm
- 2 stickers/sheet
- No. 031

150-1058

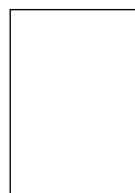

- 210x297 mm
- 1 etykieta/ark.
- 210x297 mm
- 1 sticker/sheet
- No. 032

150-1059

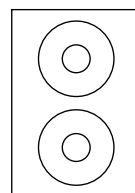

- Ø 118 mm
- 2 etykiety/ark.
- Ø 117 mm
- 2 stickers/sheet
- No. 033

150-1060

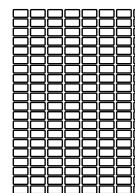

- 22x12 mm
- 160 etykiet/ark.
- 22x12 mm
- 160 stickers/sheet
- No. 034

150-1061



## Etykiety samoprzylepne kolorowe

- fluorescencyjne kolory
- arkusze formatu A4
- do drukarek atramentowych, laserowych i kserokopiarek
- opak. 25 arkuszy

## Color adhesive stickers

- fluorescent colors
- A4 sheets
- for ink jet, laser jet and copiers
- box of 25 sheets

drukarki  
atramentowe  
ink jetdrukarki laserowe  
laser jetkserokopiarki  
copiers

A4

25



- czerwona
- red
- No. 061

150-1062



- różowa
- pink
- No. 062

150-1063



- zielona
- green
- No. 063

150-1064

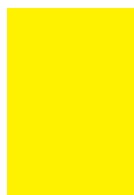

- żółta
- yellow
- No. 064

150-1065



- pomarańczowa
- orange
- No. 065

150-1066



- niebieska
- blue
- No. 066

150-1365



## Etykiety do metkownic

- 2 rodzaje: proste i faliste
- zastosowanie: metkownice jedno- i dwurzędowe
- opakowanie: 5 rolek

## Stickers for labeling machines

- 2 types: straight and wavy
- for single- and double-row labeling machines
- shrink: 5 rolls

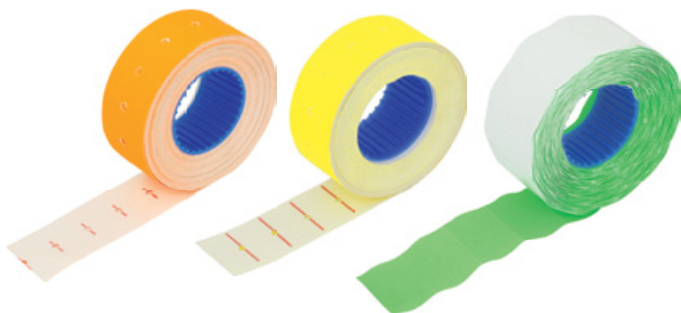

### do metkownic jednorzędowych

• rolka 800 szt.



- 22x12
- stupek 5 rolek
- shrink: 5 rolls

150-1068



- 22x12
- stupek 5 rolek
- shrink: 5 rolls

150-1069



- 22x12
- stupek 5 rolek
- shrink: 5 rolls

150-1070



- 22x12
- stupek 5 rolek
- shrink: 5 rolls

150-1071



- 22x12
- stupek 5 rolek
- shrink: 5 rolls

150-1072



- 26x12
- stupek 5 rolek
- shrink: 5 rolls

150-1073



- 26x12
- stupek 5 rolek
- shrink: 5 rolls

150-1074



- 26x12
- stupek 5 rolek
- shrink: 5 rolls

150-1075



- 26x12
- stupek 5 rolek
- shrink: 5 rolls

150-1076



- 26x12
- stupek 5 rolek
- shrink: 5 rolls

150-1077



### do metkownic dwurzędowych

• rolka 700 szt.



- 26x16
- stupek 5 rolek
- shrink: 5 rolls

150-1083



- 26x16
- stupek 5 rolek
- shrink: 5 rolls

150-1084



- 26x16
- stupek 5 rolek
- shrink: 5 rolls

150-1085



- 26x16
- stupek 5 rolek
- shrink: 5 rolls

150-1086



- 26x16
- stupek 5 rolek
- shrink: 5 rolls

150-1087



- 26x16
- stupek 5 rolek
- shrink: 5 rolls

150-1078



- 26x16
- stupek 5 rolek
- shrink: 5 rolls

150-1079



- 26x16
- stupek 5 rolek
- shrink: 5 rolls

150-1080



- 26x16
- stupek 5 rolek
- shrink: 5 rolls

150-1081



- 26x16
- stupek 5 rolek
- shrink: 5 rolls

150-1082



### for double-row labeling machines

• roll 700 pcs.



## Papiery fotograficzne – tabela cech

## Photo paper – comparison



TYP PAPIERU PAPER TYPE	SYMBOL SYMBOL	RÓDZAJ SURFACE	FORMAT FORMAT	GRAMATURA WEIGHT	ROZDZIELCZOŚĆ RESOLUTION
STANDARD	4G230	błyszczący glossy	A4	230 g/m <sup>2</sup> gsm	5760 dpi
STANDARD	6G230	błyszczący glossy	A6	230 g/m <sup>2</sup> gsm	5760 dpi
STANDARD	4G180	błyszczący glossy	A4	180 g/m <sup>2</sup> gsm	5760 dpi
STANDARD	4G130	błyszczący glossy	A4	130 g/m <sup>2</sup> gsm	5760 dpi
STANDARD	4M140	matowy matt	A4	140 g/m <sup>2</sup> gsm	5760 dpi
STANDARD	4M190	matowy matt	A4	190 g/m <sup>2</sup> gsm	5760 dpi
PREMIUM	4PPG200	błyszczący glossy	A4	200 g/m <sup>2</sup> gsm	5760 dpi
PREMIUM	3PPG230	błyszczący glossy	A3	230 g/m <sup>2</sup> gsm	5760 dpi
ADHESIVE	4PAG130	samoprzylepny, błyszczący adhesive, glossy	A4	130 g/m <sup>2</sup> gsm	5760 dpi
CD LABELS	4PLG130	etykiety do CD, błyszczący CD labels, glossy	A4	130 g/m <sup>2</sup> gsm	5760 dpi
MAGNETIC	4PMG320	magnetyczny, błyszczący magnetic, glossy	A4	320 g/m <sup>2</sup> gsm	5760 dpi
SATIN	4PS260	satynowy satin	A4	260 g/m <sup>2</sup> gsm	5760 dpi
LASER	L4G200	błyszczący glossy	A4	200 g/m <sup>2</sup> gsm	5760 dpi
LASER	L4G160	błyszczący glossy	A4	160 g/m <sup>2</sup> gsm	5760 dpi



[www.yellowone.pl](http://www.yellowone.pl)





## Papier fotograficzny Standard

- specjalna powłoka o brylantowej bieli zapewnia idealne wydruki fotograficzne w naturalnych kolorach
- wodoodporny i szybko schnący
- zdjęcia wyróżniają się ostrością oraz imponującym kontrastem
- rodzaje papieru: matowy, błyszczący



drukarki atramentowe ink jet

A4 A6 5760 dpi



### błyszczący

### glossy

INDEKS INDEX	SYMBOL SYMBOL	FORMAT FORMAT	OPAKOWANIE PACKAGING	GRAMATURA WEIGHT	EAN BARCODE
150-1181	4G230	A4	20 ark. sheets	230 g/m <sup>2</sup> gsm	5 903364 238056
150-1182	6G230	A6	20 ark. sheets	230 g/m <sup>2</sup> gsm	5 903364 238063
150-1373	4G180	A4	20 ark. sheets	180 g/m <sup>2</sup> gsm	5 903364 238186
150-1177	4G130	A4	20 ark. sheets	130 g/m <sup>2</sup> gsm	5 903364 238032

### matowy

### matt

INDEKS INDEX	SYMBOL SYMBOL	FORMAT FORMAT	OPAKOWANIE PACKAGING	GRAMATURA WEIGHT	EAN BARCODE
150-1178	4M140	A4	50 ark. sheets	140 g/m <sup>2</sup> gsm	5 903364 238018
150-1180	4M190	A4	50 ark. sheets	190 g/m <sup>2</sup> gsm	5 903364 238025

## Standard photo paper

- brilliant white surface provides perfect printouts with natural colors
- water-resistant, quick-dry
- printouts stand out with sharpness and impressive contrast
- matt and glossy paper

## Papier fotograficzny Premium

- błyszczący, śnieżnobiały papier fotograficzny
- perfekcyjne odwzorowanie barw, głębia koloru
- idealny do wydruku zdjęć w dużym formacie
- wodoodporny, szybko schnący



drukarki atramentowe ink jet

A3 A4 20 5760 dpi



## Premium photo paper

- glossy, premium white photo paper
- perfect tone image & color depth
- appropriate for large format printouts
- water-resistant, quick dry

INDEKS INDEX	SYMBOL SYMBOL	FORMAT FORMAT	OPAKOWANIE PACKAGING	GRAMATURA WEIGHT	EAN BARCODE
150-1285	4PPG200	A4	20 ark. sheets	200 g/m <sup>2</sup> gsm	5 903364 238131
150-1366	3PPG230	A3	20 ark. sheets	230 g/m <sup>2</sup> gsm	5 903364 238158



## Papier fotograficzny Laser

- specjalna powłoka o brylantowej bieli zapewnia idealne wydruki fotograficzne w naturalnych kolorach
- wodoodporny i szybkoschnący
- wysokochłonny, dwustronny



**A4** **20** **5760 dpi**

**! laser** | **dwustronny**  
laser jet | double-sided

INDEKS INDEX	SYMBOL SYMBOL	RODZAJ SURFACE	OPAKOWANIE PACKAGING	GRAMATURA WEIGHT	EAN BARCODE
150-1377	L4G160	błyszczący glossy	20 ark. sheets	160 g/m <sup>2</sup> gsm	5 903364 238193
150-1378	L4G200	błyszczący glossy	20 ark. sheets	200 g/m <sup>2</sup> gsm	5 903364 238209



## Laser jet photo paper

- glossy, premium white photo paper
- perfect tone image & color depth
- water-resistant, quick dry
- high absorption, double-sided

## Papier fotograficzny Adhesive

- samoprzylepny papier fotograficzny
- śnieżnobiały
- przylega do większości powierzchni
- perfekcyjne odwzorowanie barw, głębia koloru
- wodoodporny, szybkoschnący



**A4** **20** **5760 dpi**

INDEKS INDEX	SYMBOL SYMBOL	RODZAJ SURFACE	OPAKOWANIE PACKAGING	GRAMATURA WEIGHT	EAN BARCODE
150-1288	4PAG-130	błyszczący glossy	20 ark. sheets	130 g/m <sup>2</sup> gsm	5 903364 238087

## Adhesive photo paper

- premium white photo paper
- adhesive to most surfaces
- perfect tone image & color depth
- water-resistant, quick dry



## Papier fotograficzny Satin

- satynowy papier fotograficzny z innowacyjną technologią struktury „micro-porous”
- delikatny brylantowy połysk
- perfekcyjne odwzorowanie barw, głębia koloru
- wodoodporny, szybkoschnący



**A4** **20** **260 g/m<sup>2</sup> gsm** **5760 dpi**

INDEKS INDEX	SYMBOL SYMBOL	RODZAJ SURFACE	OPAKOWANIE PACKAGING	GRAMATURA WEIGHT	EAN BARCODE
150-1287	4PS260	satynowy satin	20 ark. sheets	260 g/m <sup>2</sup> gsm	5 903364 238070

## Satin photo paper

- satin, premium white photo paper
- innovative „micro-porous” structure provides subtle brilliant luster
- perfect tone image & color depth
- water-resistant, quick dry





## Papier fotograficzny Magnetic

- błyszczący, śnieżnobiały papier fotograficzny
- magnetyczny spód przylega do metalowych powierzchni
- perfekcyjne odwzorowanie barw, głębia koloru
- łatwy do wycinania
- wodoodporny, szybkoschnący

## Magnetic photo paper

- glossy, premium white photo paper
- magnetic bottom adheres to metal surfaces
- perfect tone image & color depth
- easy to cut
- water-resistant, quick dry



drukarki  
atramentowe  
ink jet

A4

5

320  
g/m<sup>2</sup>  
gsm

5760  
dpi

INDEKS  
INDEX

150-1290

SYMBOL  
SYMBOL

4PMG320

RODZAJ  
SURFACE

magnetyczny magnetic

OPAKOWANIE  
PACKAGING

5 ark. sheets

GRAMATURA  
WEIGHT

320 g/m<sup>2</sup> gsm

EAN  
BARCODE



Photo paper

Papier fotograficzny

## Kołozeszyty

- miękka oprawa
- metalowa spirala
- liniatura: kratka
- A4, A5: strony perforowane, z marginesem, dziurkowane

A4 A5 A6

INDEKS INDEX	SPIRALA BINDING	FORMAT FORMAT	ZAWIERA SHEETS	EAN BARCODE
150-1229	pojedyncza single	A4	160 kartek sheets	5 903364 254100
* 150-1230	pojedyncza single	A4	120 kartek sheets	5 903364 254094
150-1254	pojedyncza single	A4	96 kartek sheets	5 903364 254186
150-1231	pojedyncza single	A4	80 kartek sheets	5 903364 254087
150-1232	podwójna double	A5	50 kartek sheets	5 903364 254131
150-1233	podwójna double	A6	50 kartek sheets	5 903364 254148

\* do wyczerpania zapasów while stock lasts

## Spiral notebooks soft cover

- soft cover
- metal binding
- squared paper
- A4, A5 perforated and punched pages, with margin

Grand®



## Kołobruliony

- twarda oprawa
- podwójna metalowa spirala
- liniatura: kratka
- strony perforowane, z marginesem, dziurkowane
- kolorowe indeksy

A4 B5

INDEKS INDEX	SPIRALA BINDING	FORMAT FORMAT	ZAWIERA SHEETS	EAN BARCODE
150-1234	podwójna double	A4	160 kartek sheets	5 903364 254124
150-1235	podwójna double	A4	100 kartek sheets	5 903364 254117
150-1236	podwójna double	B5	160 kartek sheets	5 903364 254162
150-1237	podwójna double	B5	100 kartek sheets	5 903364 254155

## Spiral notebooks hard cover

- hard cover
- double metal binding
- squared paper
- perforated and punched pages, with margin
- color index

Grand®



## Kotobruliony z przekładkami NOTObook

- polipropylenowa okładka i kolorowe przekładki indeksujące
- podwójna metalowa spirala
- 100 kartek
- A4 – 5 przekładek, A5 – 3 przekładki
- gramatura papieru 80 g/m<sup>2</sup>

## Spiral NOTObook with index dividers

- polypropylene cover & index dividers
- double metal binding
- 100 sheets
- A4 – 5 dividers, A5 – 3 dividers
- paper weight 80 gsm



A4 A5 100 80 g/m<sup>2</sup> gsm

INDEKS INDEX	FORMAT FORMAT	LINIATURA PAPER	KOLOR COLOR	EAN BARCODE
150-1405	A4	kratka squared	niebieski blue	5 903364 254582
150-1406	A4	kratka squared	pomarańczowy orange	5 903364 254599
150-1408	A4	kratka squared	szary grey	5 903364 254612
150-1407	A4	kratka squared	zielony green	5 903364 254605
* 150-1419	A4	linia lined	niebieski blue	5 903364 254728
* 150-1420	A4	linia lined	zielony green	5 903364 254735
150-1409	A5	kratka squared	niebieski blue	5 903364 254544
150-1410	A5	kratka squared	pomarańczowy orange	5 903364 254551
150-1412	A5	kratka squared	szary grey	5 903364 254575
150-1411	A5	kratka squared	zielony green	5 903364 254568
150-1421	A5	linia lined	niebieski blue	5 903364 254704
* 150-1422	A5	linia lined	zielony green	5 903364 254711

\* do wyczerpania zapasów while stock lasts

## Bruliony

- twarda laminowana oprawa z materiałów przyjaznych dla środowiska
- grzbiet szyto-klejony
- liniatura: kratka lub linia
- oznaczone marginesy

## Notebooks

- laminated hard cover made of environmentally friendly material
- sewn-glued back
- squared or lined paper
- marked margins



A4 B5 A5 A6

INDEKS INDEX	FORMAT FORMAT	ZAWIERA SHEETS	LINIATURA PAPER	EAN BARCODE
150-1239	A4	96 kartek sheets	kratka squared	5 903364 254230
150-1323	A4	96 kartek sheets	linia lined	5 903364 252595
150-1329	B5	160 kartek sheets	kratka squared	5 903364 254247
150-1223	A5	96 kartek sheets	kratka squared	5 903364 254216
150-1222	A5	96 kartek sheets	linia lined	5 903364 254223

## Notatniki z gumką

- twarda oprawa
- grzbiet szyto-klejony
- uchwyt na długopis i wewnętrzna kieszeń
- wygodna zakładka
- 80 kartek
- gramatura papieru 80 g/m<sup>2</sup>



INDEKS INDEX	FORMAT FORMAT	LINIATURA PAPER	KOLOR COLOR	EAN BARCODE
150-1381	A5	kratka squared	● czarny black	5 903364 254377
150-1382	A5	kratka squared	● czerwony red	5 903364 254384
150-1383	A5	kratka squared	● granatowy navy blue	5 903364 254391
* 150-1423	A5	linia lined	● czarny black	5 903364 254650
150-1424	A5	linia lined	● granatowy navy blue	5 903364 254667
150-1399	A6	kratka squared	● czarny black	5 903364 254476
150-1401	A6	kratka squared	● czerwony red	5 903364 254483
150-1400	A6	kratka squared	● granatowy navy blue	5 903364 254490
* 150-1402	A6	kratka squared	● pomarańczowy orange	5 903364 254506
* 150-1425	A6	linia lined	● czarny black	5 903364 254674
* 150-1426	A6	linia lined	● granatowy navy blue	5 903364 254681
150-1416	A6	kratka squared	display 12 szt. pcs.	5 903364 254513

\* do wyczerpania zapasów while stock lasts

## Notebooks with rubber band

- hard cover
- sewn-glued back
- pocket and pen holder inside
- comfortable bookmark
- 80 sheets
- paper weight 80 gsm

Grand®



## Notatniki z cekinami

- twarda oprawa z cekinami
- cekiny można odwracać, by zmienić kolorystykę lub tworzyć wzory
- grzbiet szyto-klejony
- 96 kartek
- gramatura papieru 80 g/m<sup>2</sup>

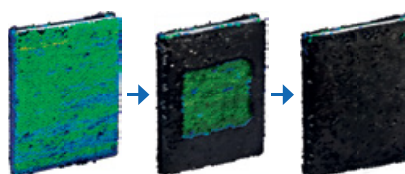
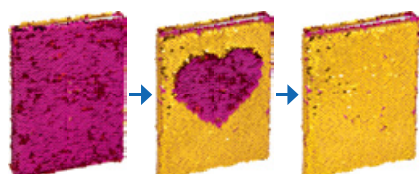

INDEKS INDEX	FORMAT FORMAT	LINIATURA PAPER	KOLOR COLOR	EAN BARCODE
* 150-1427	A5	linia lined	● różowo-złoty pink&gold	5 903364 254698
* 150-1428	A5	linia lined	● zielono-czarny black&green	5 903364 254742

\* do wyczerpania zapasów while stock lasts

## Sequin notebooks

- hard cover with sequins
- sequins can be flipped to change colors or create patterns
- sewn-glued back
- 96 sheets
- paper weight 80 gsm

Grand®

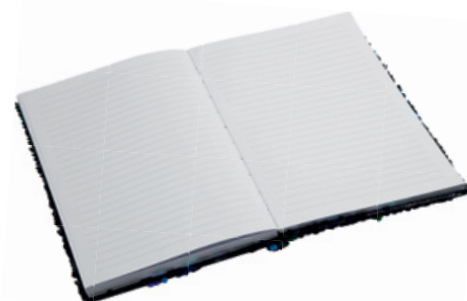

## Dzienniki korespondencyjne

- twarda oprawa
- format A4

## Correspondence books

- hard cover
- A4 format

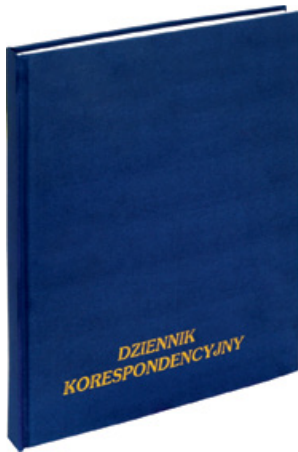

A4



**INDEKS**  
INDEX

**FORMAT**  
FORMAT

**ZAWIERA**  
SHEETS

150-1026

A4

96 kartek sheets

150-1027

A4

192 kartki sheets

**EAN**  
BARCODE



## Skorowidze alfabetyczne

- twarda laminowana oprawa
- grzbiet szyto-klejony
- liniatura: kratka

## Letter indexes

- laminated hard cover
- sewn-glued back
- squared paper



A4 2/3 A4 A5 2/3 A5 A6



**INDEKS**  
INDEX

**FORMAT**  
FORMAT

**ZAWIERA**  
SHEETS

\* 150-1187

A4

192 kartki sheets

150-1188

A4

96 kartek sheets

150-1190

2/3 A4

96 kartek sheets

150-1191

A5

96 kartek sheets

150-1192

2/3 A5

96 kartek sheets

150-1193

A6

96 kartek sheets

**EAN**  
BARCODE

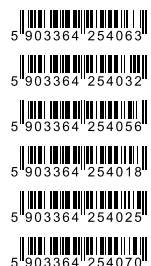

\* do wyczerpania zapasów while stock lasts

## Kostka biurowa biała

- wyprodukowano w Polsce
- wymiary 85x85x35 mm

## White paper cube

- made in Poland
- size 85x85x35 mm



INDEKS INDEX	SYMBOL SYMBOL	RODZAJ TYPE	ZAWIERA SHEETS	EAN BARCODE
150-1433	GR-350K	klejona glued	350 kartek sheets	
150-1434	GR-350N	nieklejona not-glued	350 kartek sheets	





## Notes na spirali

- min. 38 gładkich kartek, miks wzorów

## Spiral note

- min. 38 plain sheets, assorted designs

INDEKS INDEX	KSZTAŁT SHAPE	ROZMIAR SIZE	EAN BARCODE
150-1449	piłka ball	7x8 cm	
150-1451	lama, brokat lama, glitter	8,5x10,5 cm	
150-1450	delfin, brokat dolphin, glitter	6,5x13 cm	
150-1447	syrenka/pony, brokat mermaid/pony, glitter	8x10 cm	
150-1448	klapek, brokat slipper, glitter	6,5x13 cm	

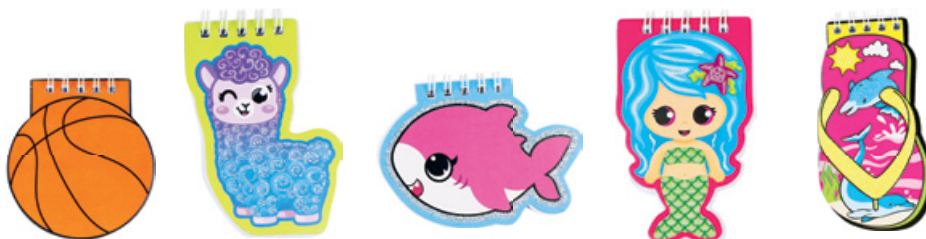

## Notesy samoprzylepne kształty

- po odklejeniu nie pozostawiają śladów
- wszechstronne zastosowanie w domu, biurze i w szkole
- doskonałe rozwiązanie do oznaczania, zapisywania i przekazywania informacji

## Sticky notes shapes

- leave no stains after removing
- multi-purpose at home, school and office
- perfect solution for labeling, taking notes and delivering messages



INDEKS INDEX	SYMBOL SYMBOL	KSZTAŁT SHAPE
150-1429	GR-40B	chmurka cloud
150-1430	GR-40W	strzałka arrow
150-1431	GR-40R	ręka hand

EAN	BARCODE
5 903364 218492	
5 903364 218515	
5 903364 218539	

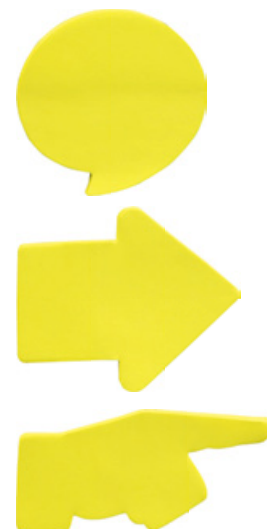



## Notesy samoprzylepne

- po odklejeniu nie pozostawiają śladów
- wszechstronne zastosowanie w domu, biurze i w szkole
- doskonałe rozwiązanie do oznaczania, zapisywania i przekazywania informacji

## Sticky notes

- leave no stains after removing
- multi-purpose at home, school and office
- perfect solution for labeling, taking notes and delivering messages

### żółte

- 100 karteczek w kolorze żółtym

### yellow

- 100 yellow sheets



INDEKS INDEX SYMBOL SYMBOL ROZMIAR SIZE

□	150-1136	653		40x50 mm
	150-1131	656		50x75 mm
	150-1134	654		75x75 mm
	150-1137	657		75x100 mm
	150-1138	655		75x125 mm

EAN BARCODE



□ opak. 2 szt. 2 piece set

### kolorowe

- 300 karteczek w trzech kolorach

### color

- 300 sheets in three colors



INDEKS INDEX SYMBOL SYMBOL ROZMIAR SIZE

	150-1238	653-3K		40x50 mm
	150-1140	656-3K		50x75 mm
	150-1141	654-3K		75x75 mm

EAN BARCODE



### czarne

- notes 100 karteczek  
lub zestaw 2 notesy, 2 długopisy

### black

- sticky notes 100 sheets or set: 2 sticky notes, 2 gel pens

INDEKS INDEX SYMBOL SYMBOL ROZMIAR SIZE ZESTAW SET

	150-1452	654 BL		75x75 mm	notes sticky note
	150-1453	654 BL-2P		75x75 mm	2 notesy, 2 długopisy srebrne 2 sticky notes, 2 silver gel pens

EAN BARCODE



## Zakładki indeksujące

- po odklejeniu nie pozostawiają śladów
- prosty sposób na oznaczenie ważnych informacji w książce czy katalogu
- dają możliwość znakowania kolorem różnych kategorii informacji
- wykonane z papieru
- zestaw 4 kolorów

INDEKS INDEX	SYMBOL SYMBOL	KOLORY COLORS	ROZMIAR SIZE	EAN BARCODE
150-1244	659-4N	neonowe neon	15x50 mm	5 903364 215309
150-1243	659-5P	pastelowe pastel	15x50 mm	5 903364 215323
150-1374	652-5P	pastelowe pastel	20x50 mm	5 903364 203757

## Indicator tags

- leave no stains after removing
- easy way to mark important information in books or catalogues
- different colors enable marking various categories of information
- made of paper
- set of 4 colors



## Zakładki indeksujące

- po odklejeniu nie pozostawiają śladów
- prosty sposób na oznaczenie ważnych informacji w książce czy katalogu
- dają możliwość znakowania kolorem różnych kategorii informacji

## Indicator tags

- leave no stains after removing
- easy way to mark important information in books or catalogues
- different colors enable marking various categories of information



## papierowe

- wykonane z papieru
- zestaw 4 kolorów

INDEKS INDEX	SYMBOL SYMBOL	ZESTAW SET	ROZMIAR SIZE	EAN BARCODE
150-1418	GR-24-50	4 kolory po 50 szt. 4 colors 50 pcs. each	50x20 mm	5 903364 218287

## paper

- made of paper
- set of 4 colors



## strzałki

- foliowe

INDEKS INDEX	SYMBOL SYMBOL	ZESTAW SET	ROZMIAR SIZE	EAN BARCODE
150-1417	GR-25-25	5 kolorów po 25 szt. 5 colors 25 pcs. each	45x12 mm	5 903364 218263
150-1440	GR-255W	5 kolorów po 25 szt. 5 colors 25 pcs. each	45x23 mm	5 903364 218775

## arrows

- made of film



## z nadrukiem

- foliowe

INDEKS INDEX	SYMBOL SYMBOL	RODZAJ TYPE	ZAWIERA SHEETS	ROZMIAR SIZE	EAN BARCODE
150-1441	GR-206W	wiśnie cherries	6x20 kartek sheets	45x12 mm	5 903364 218799
150-1442	GR-206L	liście leaves	6x20 kartek sheets	45x12 mm	5 903364 218812

## printed

- made of film



**TOOR**<sup>®</sup>  
**ELECTRONIC**

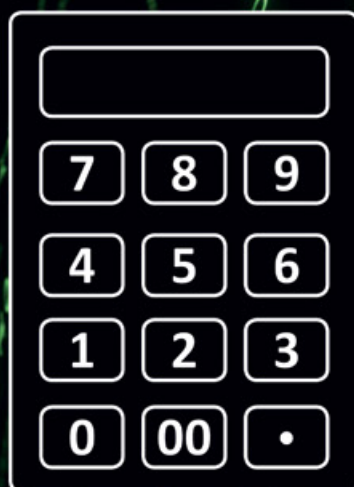

[www.toor.com.pl](http://www.toor.com.pl)

**calculators & cleaning products**  
**kalkulatory, artykuły czyszczące**



**Kalkulatory TOOR Electronic** to wyjątkowe urządzenia: ich wysoka jakość i trwałość potwierdzona jest dożywotnią gwarancją. Zarejestruj się na [www.toor.com.pl](http://www.toor.com.pl).

TOOR electronic calculators are unique devices: their high quality and durability has been confirmed by lifetime warranty. Register at [www.kwtrade.pl](http://www.kwtrade.pl).



**TOOR**<sup>®</sup>  
ELECTRONIC

### Kalkulator kieszonkowy TR-252

- kasowanie ostatniej pozycji
- rozmiar: 101x62x11 mm

### Pocket calculator TR-252

- clear enter function
- size: 101x62x11 mm

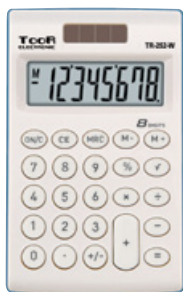

INDEKS INDEX

KOLOR COLOR

EAN BARCODE

120-1418

○ biały white



120-1771

● zielony green



120-1772

● czarny black



**TOOR**<sup>®</sup>  
ELECTRONIC

### Kalkulator kieszonkowy TR-295

- kasowanie ostatniej pozycji
- rozmiar: 90x55x11 mm

### Pocket calculator TR-295

- clear enter function
- size: 90x55x11 mm



INDEKS INDEX

KOLOR COLOR

EAN BARCODE

120-1419

○ biało-pomarańczowy  
orange & white



120-1769

● biało-czarny  
black & white



120-1770

● biało-zielony  
green & white



## Kalkulator kieszonkowy TR-225 z klapką

- kasowanie ostatniej pozycji
- rozmiar: 104x63x11 mm

## Flap-case calculator TR-225

- clear enter function
- size: 104x63x11 mm

**TOOR**<sup>®</sup>  
ELECTRONIC



INDEKS INDEX

EAN BARCODE

120-1856

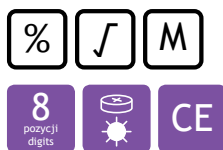

## Kalkulator kieszonkowy TR-227K z klapką

- klawisz cofania ostatniej cyfry
- kasowanie ostatniej pozycji
- rozmiar: 102x60x12 mm

## Flap-case calculator TR-227K

- correction key
- clear enter function
- size: 102x60x12 mm

**TOOR**<sup>®</sup>  
ELECTRONIC



INDEKS INDEX

EAN BARCODE

120-1857



## Kalkulator kieszonkowy dwuliniowy TR-310DB-W

- kasowanie ostatniej pozycji
- klawisze przechodzenia pomiędzy cyframi
- wykonywanie działań w nawiasach
- rozmiar: 118x70x10 mm

## 2-line pocket calculator TR-310DB-W

- clear enter function
- move to right and left keys
- brackets
- size: 118x70x10 mm

**TOOR**<sup>®</sup>  
ELECTRONIC



INDEKS INDEX

EAN BARCODE

120-1904

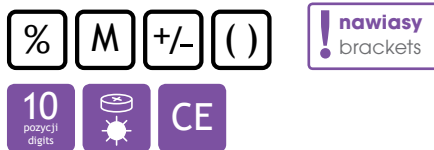



**TOOR**<sup>®</sup>  
ELECTRONIC

### Kalkulator dwuliniowy TR-1223DB

- kasowanie ostatniej pozycji
- klawisze przechodzenia pomiędzy cyframi
- wykonywanie działań w nawiasach
- rozmiar: 148x105x20 mm

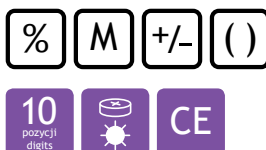
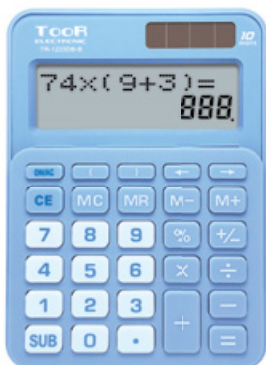

### 2-line calculator TR-1223DB

- clear enter function
- move to right and left keys
- brackets
- size: 148x105x20 mm

INDEKS INDEX	KOLOR COLOR	EAN BARCODE
120-1901	● niebieski blue	5 903364 218676
120-1902	● różowy pink	5 903364 218690
120-1900	○ biały white	5 903364 218713



**TOOR**<sup>®</sup>  
ELECTRONIC

### Kalkulator dwuliniowy TR-2429DB-K

- kasowanie ostatniej pozycji
- klawisze przechodzenia pomiędzy cyframi
- wykonywanie działań w nawiasach
- rozmiar: 145x105x33 mm

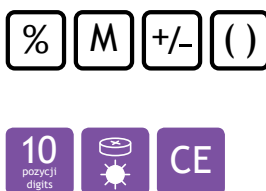

### 2-line calculator TR-2429DB-K

- clear enter function
- move to right and left keys
- brackets
- size: 145x105x33 mm

INDEKS INDEX	EAN BARCODE
120-1903	5 903364 218737



**TOOR**<sup>®</sup>  
ELECTRONIC

### Kalkulator biurowy TR-2245

- marża/obniżka
- klawisz cofania ostatniej cyfry
- kasowanie ostatniej pozycji
- rozmiar: 142x105x23 mm

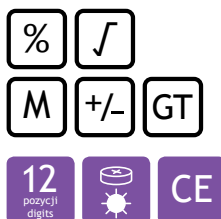
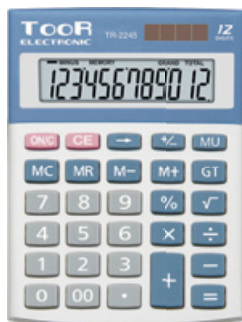

### Desk calculator TR-2245

- margin/reduction function
- correction key
- clear enter function
- size: 142x105x23 mm

INDEKS INDEX	EAN BARCODE
120-1424	5 903364 216177

## Kalkulator biurowy TR-2382

- marża/obniżka
- klawisz cofania ostatniej cyfry
- kasowanie ostatniej pozycji
- wybór trybu przecinka
- całkowite kasowanie rejestrów i pamięci
- rozmiar: 147x104x33 mm

## Desk calculator TR-2382

- margin/reduction function
- correction key
- clear enter function
- rounding selector
- all clear function
- size: 147x104x33 mm

**TOOR**<sup>®</sup>  
ELECTRONIC



INDEKS INDEX

120-1432

EAN BARCODE

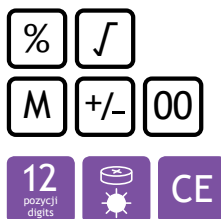

## Kalkulator biurowy TR-2242

- dwie niezależne pamięci
- marża/obniżka
- klawisz cofania ostatniej cyfry
- kasowanie ostatniej pozycji
- całkowite kasowanie rejestrów i pamięci
- wybór trybu przecinka i ilości miejsc po przecinku
- rozmiar: 145x137x33 mm

## Desk calculator TR-2242

- two independent memory functions
- margin/reduction function
- correction key
- clear enter function
- all clear function
- rounding and decimal selector
- size: 145x137x33 mm

**TOOR**<sup>®</sup>  
ELECTRONIC



**! podwójna pamięć**  
memory I, memory II

INDEKS INDEX

120-1458

EAN BARCODE

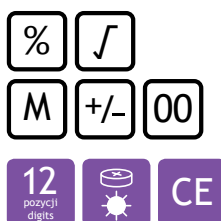

## Kalkulator biurowy TR-2464C

- duży wyświetlacz LCD
- check&correct – sprawdzanie i poprawianie obliczeń do 120 kroków
- kasowanie ostatniej pozycji
- całkowite kasowanie rejestrów i pamięci
- rozmiar: 148x96x34 mm

## Desk calculator TR-2464C

- large LCD display
- check&correct function up to 120 steps
- clear enter function
- all clear function
- size: 148x96x34 mm

**TOOR**<sup>®</sup>  
ELECTRONIC



**! check & correct**

INDEKS INDEX

120-1476

EAN BARCODE







**TOOR**<sup>®</sup>  
ELECTRONIC

### Kalkulator biurowy TR-2213A

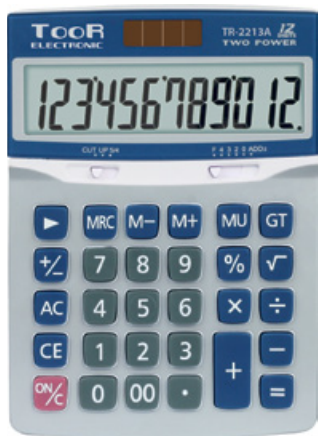

- marża/obniżka
- wybór trybu przecinka i ilości miejsc po przecinku
- klawisz cofania ostatniej cyfry
- kasowanie ostatniej pozycji
- całkowite kasowanie rejestrów i pamięci
- rozmiar: 170x125x36 mm



### Desk calculator TR-2213A

- margin/reduction function
- rounding and decimal selector
- correction key
- clear enter function
- all clear function
- size: 170x125x36 mm

INDEKS INDEX

EAN BARCODE

120-1858



**TOOR**<sup>®</sup>  
ELECTRONIC

### Kalkulator biurowy TR-2296T



- klawisz ustalenia stopy podatkowej
- klawisz cofania ostatniej cyfry
- kasowanie ostatniej pozycji
- wodoodporny
- rozmiar: 158x106x35 mm

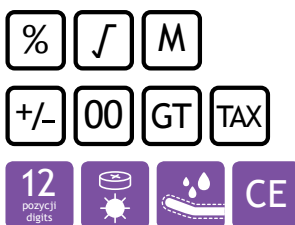

### Desk calculator TR-2296T

- tax setting key
- correction key
- clear enter function
- waterproof
- size: 158x106x35 mm

INDEKS INDEX

EAN BARCODE

120-1425



**TOOR**<sup>®</sup>  
ELECTRONIC

### Kalkulator biurowy TR-1216



- marża/obniżka
- wybór trybu przecinka i ilości miejsc po przecinku
- klawisz cofania ostatniej cyfry
- kasowanie ostatniej pozycji
- całkowite kasowanie rejestrów i pamięci
- ruchomy wyświetlacz
- rozmiar: 186x112x29 mm



### Desk calculator TR-1216

- margin/reduction function
- rounding and decimal selector
- correction key
- clear enter function
- all clear function
- adjustable display
- size: 186x112x29 mm

INDEKS INDEX

EAN BARCODE

120-1835



## Kalkulator biurowy TR-2266A

- marża/obniżka
- wybór trybu przecinka i ilości miejsc po przecinku
- klawisz cofania ostatniej cyfry
- kasowanie ostatniej pozycji
- całkowite kasowanie rejestrów i pamięci
- ruchomy wyświetlacz
- rozmiar: 194x129x31 mm (maks. 62)

## Desk calculator TR-2266A

- margin/reduction function
- rounding and decimal selector
- correction key
- clear enter function
- all clear function
- adjustable display
- size: 194x129x31 mm (max. 62)

**TOOR**<sup>®</sup>  
ELECTRONIC



INDEKS INDEX

120-1456

EAN BARCODE



## Kalkulator biurowy TR-2260

- marża/obniżka
- wybór trybu przecinka i ilości miejsc po przecinku
- klawisz cofania ostatniej cyfry
- kasowanie ostatniej pozycji
- całkowite kasowanie rejestrów i pamięci
- ruchomy wyświetlacz
- rozmiar: 200x140x23 mm

## Desk calculator TR-2260

- margin/reduction function
- rounding and decimal selector
- correction key
- clear enter function
- all clear function
- adjustable display
- size: 200x140x23 mm

**TOOR**<sup>®</sup>  
ELECTRONIC



INDEKS INDEX

120-1859

EAN BARCODE

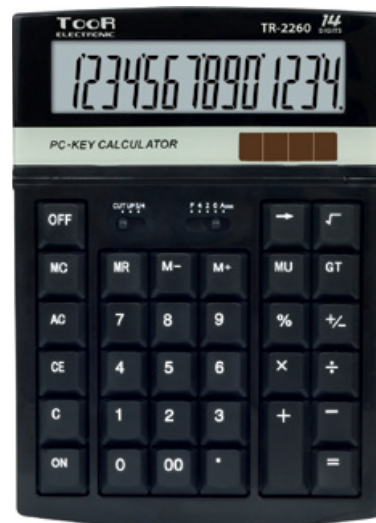
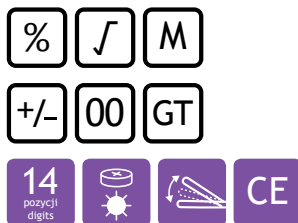



**TOOR**<sup>®</sup>  
ELECTRONIC

## Kalkulator biurowy TR-2235A-W

- wybór trybu przecinka i ilości miejsc po przecinku
- klawisz cofania ostatniej cyfry
- kasowanie ostatniej pozycji
- całkowite kasowanie rejestrów i pamięci
- rozmiar: 208x146x39 mm

## Desk calculator TR-2235A-W

- rounding and decimal selector
- correction key
- clear enter function
- all clear function
- size: 208x146x39 mm

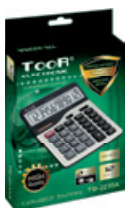

INDEKS INDEX

EAN BARCODE

120-1451



**TOOR**<sup>®</sup>  
ELECTRONIC

## Kalkulator biurowy TR-2239T

- marża/obniżka
- klawisz ustalenia stopy podatkowej
- wybór trybu przecinka i ilości miejsc po przecinku
- klawisz cofania ostatniej cyfry
- kasowanie ostatniej pozycji
- całkowite kasowanie rejestrów i pamięci
- rozmiar: 204x154x35 mm

## Desk calculator TR-2239T

- margin/reduction function
- tax key
- rounding and decimal selector
- correction key
- clear enter function
- all clear function
- size: 204x154x35 mm

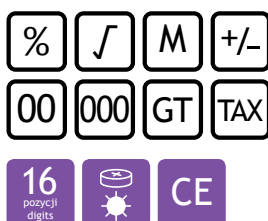

INDEKS INDEX

EAN BARCODE

120-1452



## Kalkulator naukowy TR-511

- 2-liniowy wyświetlacz
- kasowanie ostatniej pozycji
- wybór ilości miejsc po przecinku
- 240 operacji matematycznych
- wyświetlanie liczb w postaci półlogarytmicznej
- całkowite kasowanie rejestrów i pamięci
- rozmiar: 162x84x18 mm

## Scientific calculator TR-511

- 2-line display
- clear enter function
- decimal selector
- 240 functions
- logarithm
- all clear function
- size: 162x84x18 mm

**TOOR**<sup>®</sup>  
ELECTRONIC

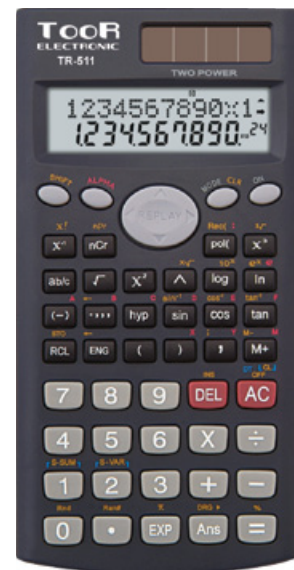

INDEKS INDEX

120-1420

EAN BARCODE

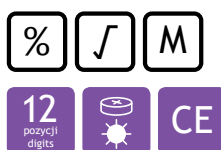

## Kalkulator graficzny TR-523

- wyświetlacz graficzny
- wybór ilości miejsc po przecinku
- 360 operacji matematycznych
- wyświetlanie liczb w postaci półlogarytmicznej
- kreślenie wykresów funkcji
- rozwiązywanie równań
- obliczenia statystyczne
- kasowanie ostatniej pozycji
- całkowite kasowanie rejestrów i pamięci
- rozmiar: 174x84x18 mm

## Graphical calculator TR-523

- graphical display
- decimal selector
- 360 functions
- logarithm
- function graphing
- equations
- statistic calculations
- clear enter function
- all clear function
- size: 174x84x18 mm

**TOOR**<sup>®</sup>  
ELECTRONIC



**Zasilanie:** Do prawidłowego działania kalkulatora wystarczy jedna bateria (dołączona do produktu). Produkt przewiduje także możliwość przedłużenia działania: miejsce na dodatkową baterię, która może wydłużyć żywotność kalkulatora o 60%.

**Power:** for correct operation the calculator needs one battery (included). The product also provides the possibility of using two batteries to extend the operating time by 60%.

INDEKS INDEX

\* 120-1457

EAN BARCODE

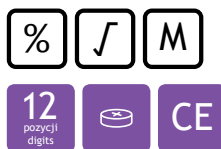

\* do wyczerpania zapasów while stock lasts



90% materiałów, z których produkowane są artykuły czyszczące Yellow One, pochodzi z Europy, w tym blisko 60% z Niemiec. Produkty spełniają wszystkie regulacje prawne obowiązujące w Unii Europejskiej. Wysokiej jakości opakowania i materiały gwarantują pełną efektywność w całym okresie przydatności.

90% of materials used for cleaning accessories Yellow One come from Europe, almost 60% from Germany. Cleaning accessories meet all the adequate regulations of European Union. High quality packaging and materials guarantee full effectivity.

## Żel czyszczący

- wyjątkowa konsystencja żelu
- bardziej wydajny niż tradycyjny płyn czyszczący
- nie ścieka z czyszczonych powierzchni
- do ekranów TFT/LCD oraz plazmowych, laptopów, skanerów, powierzchni szklanych itp.
- nie zawiera alkoholu
- zbiera kurz i brud, nie pozostawia smug
- w zestawie ściereczka z mikrofibry (18x18 cm) GRATIS



## Cleaning gel

- original gel consistency
- more efficient than traditional cleaning liquid
- no dripping from surface
- for TFT/LCD and plasma screens, laptops, scanners, glass surfaces etc.
- contains no alcohol
- provides streak free cleaning
- microfible cloth included (18x18 cm)

200 ml

INDEKS INDEX

EAN BARCODE

★ 125-1035



★ do wyczerpania zapasów while stock lasts

## Płyn do ekranów

- bezpieczna, delikatna formuła płynu do ekranów TFT/LCD, laptopów, powierzchni szklanych itp.
- atomizer rozpyla delikatną mgiełkę, która równomiernie osiada na ekranie
- płyn nie zawiera alkoholu, jest niepalny i przyjazny dla środowiska
- w zestawie ściereczka z mikrofibry (40x40 cm) GRATIS
- zapach cytrusowy



## Screen cleaner

- special cleaning spray for TFT/LCD screens, laptops, glass surfaces etc.
- atomizer sprays fine mist that settles evenly on screen
- liquid contains no methanol and it is not flammable
- environmentally friendly
- microfible cloth included (40x40 cm)
- citrus scent

250 ml

INDEKS INDEX

EAN BARCODE

125-1033



## Chusteczki czyszczące

- nasączone chusteczki do ekranów TFT/LCD, laptopów, ekranów płaskich, tabletów, powierzchni szklanych, luster, soczewek itp.
- płyn jest niepalny, nie zawiera alkoholu
- miękkie w dotyku, nie pozostawiają smug
- delikatne i bezpieczne dla ekranu, nie powodują mikrozarysowań
- efekt antystatyczny, chroniący przed ponownym szybkim osiadananiem kurzu
- opakowanie posiada plombę chroniącą przed wysychaniem
- nie żółkną
- na bazie papieru – nie zawierają polipropylenu



## Cleaning wipes

- soaked cleaning clothes for TFT/LCD/PDA screens, laptops and flat bed scanner screens, glass surfaces etc.
- liquid contains no methanol and it is not flammable
- clothes provide streak free cleaning
- no risk of micro-scratches
- remove dust and dirt
- anti-static for longer cleanliness
- paper-based – contain no polypropylene

100

INDEKS INDEX

EAN BARCODE

125-1034



## Spray czyszczący

produkt typu sprężone powietrze

- umożliwia usunięcie kurzu i zanieczyszczeń z trudno dostępnych przestrzeni
- do czyszczenia klawiatur, drukarek, kieszeni CD/DVD, kopiarek itp.
- w zestawie rurka przedłużająca

INDEKS INDEX

EAN BARCODE

125-1032



400 ml

## Spray duster

- blows dust and debris from inaccessible areas
- for computer keyboards, printers, CD/DVD drives, piers, fax machines etc.
- extension tube included



## Płyn do usuwania etykiet

- do bezpiecznego usuwania etykiet z wszystkich nieabsorbujących powierzchni (foliowanych okładek książek, opakowań, plastiku, metalu, szkła)
- idealny do usuwania nalepek ze sprzętu biurowego i elementów elektronicznych
- po nasączeniu etykiety klej zostaje zneutralizowany, co umożliwia całkowite i szybkie usunięcie nalepki
- może być również stosowany do usuwania tuszu i przebarwień po stosowaniu markerów
- dołączona szczoteczka pozwala usunąć resztki kleju
- nie używać do polistyrenu

## Label removal spray

- for safe removing of labels from various surfaces (laminated book covers, packages, plastic, metal, glass)
- perfect for removing labels from office equipment and electrical elements
- soaking the label neutralizes adhesives and enables complete and quick sticker removal
- may be used to remove ink and pigmentation of markers
- brush for easy removing of glue remains
- do not use on polystyrene

INDEKS INDEX

EAN BARCODE

125-1037



200 ml



## Płyn do tablic suchościeralnych i ceramicznych

- spray do pielęgnacji i dokładnego czyszczenia tablic suchościeralnych
- bezpieczny także dla tablic ceramicznych

## Whiteboard & ceramic board cleaner

- for quick and effortless cleaning of whiteboards
- safe for ceramic boards

INDEKS INDEX

EAN BARCODE

125-1039



250 ml





## Chusteczki do dezynfekcji powierzchni

- chusteczki przeznaczone do czyszczenia oraz dezynfekcji powierzchni z tworzyw sztucznych i metalowych oraz wyposażenia w pomieszczeniach socjalnych
- wykazują właściwości bakteriobójcze, grzybobójcze i wirusobójcze
- przydatne do odkażania sprzętu biurowego, tj. ekranów urządzeń mobilnych, monitorów, klawiatur, obudów komputerowych, laptopów, drukarek, kopiarek, skanerów, telefonów itp.
- rozpuszczają tłuszcz, dzięki czemu świetnie nadają się również do czyszczenia i odkażania solariumów
- bez zawartości alkoholu
- nie niszczą i nie odbarwiają dezynfekowanych powierzchni
- krótki czas ekspozycji: 60 sekund
- przyjemny zapach



## Surface disinfection wipes

- wipes designed for cleaning and disinfecting plastic and metal surfaces as well as equipment in rest and refreshment rooms
- antibacterial, fungicidal and viricidal properties
- useful for disinfecting the office equipment, screens of mobile devices, monitors, keyboards, computer cases, laptops, printers, copiers, scanners, telephones, etc.
- dissolve grease – useful for cleaning and disinfecting sunbeds and tanning beds
- alcohol-free
- do not damage or discolor disinfected surfaces
- short exposure time: 60 seconds

**! saszetki wygodne w podróży**  
sashets useful in every trip

INDEKS	INDEX	OPAK. PKG.	EAN BARCODE
125-1043		tuba 100 szt. tube 100 pcs.	5 903364 238377
125-1044		10 saszetek x2 szt. 10 sashets x2 pcs.	5 903364 238384

## Płyn do dezynfekcji rąk w sprayu

- płyn o działaniu bakteriobójczym, grzybobójczym i wirusobójczym
- niszczy aż 99,99% bakterii i wirusów
- przeznaczony do higienicznej i chirurgicznej dezynfekcji rąk
- do stosowania w warunkach domowych i obiektach użytku publicznego, idealny w podróży i na co dzień
- przydatny w komunikacji miejskiej, podczas zakupów, w restauracjach, przychodniach, po zabawie ze zwierzętami itd.
- przyjemny zapach



100 ml

## Hand sanitiser spray

- bactericidal, fungicidal and virucidal fluid
- kills up to 99.9% of fungi, viruses, and bacteria
- for hygienic and surgical hand disinfection
- for home and public facilities, perfect while travelling and daily use
- useful in public transport, shops, restaurants, clinics, after playing with animals, etc.
- nice smell

**! bagaż podręczny**  
cabin luggage capacity

INDEKS	INDEX	OPAK. PKG.	EAN BARCODE
125-1045		100 ml	5 903364 238407

**correction & writing**  
**korekcyjne i pismienne**



**Korektory w taśmie OVAL** z ruchomą końcówką i obrotowym wkładem. Symetryczny kształt i ruchoma końcówka sprawiają, że są wygodne dla prawo- i leworęcznych. Stabilizator pozwala na uzyskanie prostej linii taśmy i łatwe korygowanie pod każdym kątem. Wyjątkowe rozwiązanie: takie różne, a ten sam wkład do wszystkich!

**OVAL correction tapes** with flexible tip and pivotable tape refill. Symmetrical shape and flexible tip make them convenient for right- and left-handed. Stabilizer enables straight tape line: easy correction at any angle. Unique solution: all so different, but the same refill for every one of them!

- każdy korektor posiada indywidualny kod kreskowy
- individual barcode

[www.korektoryoval.pl](http://www.korektoryoval.pl)



### QRM-506

- kieszonkowy: długość 88 mm, średnica 22 mm
- pocket-size: 88 mm long, diameter 22 mm

5 mm  
6 m

5 lat  
years



### QAR-506

- możliwość pionowego ustawienia na biurku
- possibility of vertical positioning on desk

5 mm  
6 m

5 lat  
years



INDEKS INDEX OPAK. PKG. EAN BARCODE  
160-1972 12 szt. pcs. 4 716493 232328

INDEKS INDEX OPAK. PKG. EAN BARCODE  
160-2001 12 szt. pcs. 4 716493 212429



### QJR-506

- końcówka wysuwana po kliknięciu w przycisk długopisowy
- retractable

5 mm  
6 m

5 lat  
years



### QDR-506

- dwa rodzaje korekty: korektor w taśmie i gumka do wymazywania ołówka
- mechanizm wysuwania końcówki chroni ją przed uszkodzeniem
- two types of correction - correction tape and pencil eraser
- slide-out shield as tip protector

5 mm  
6 m

5 lat  
years



INDEKS INDEX OPAK. PKG. EAN BARCODE  
160-2000 12 szt. pcs. 4 716493 112422

INDEKS INDEX OPAK. PKG. EAN BARCODE  
160-2095 12 szt. pcs. 4 716493 000125



### QBR-506

- możliwość pionowego ustawienia na biurku
- possibility of vertical positioning on desk

5 mm  
6 m

5 lat  
years



INDEKS	INDEX	OPAK.	PKG.	EAN	BARCODE
160-2179		12 szt.	pcs.	4 716493 003744	



### QCR-506

- z klipsem
- clip

5 mm  
6 m

5 lat  
years



INDEKS	INDEX	OPAK.	PKG.	EAN	BARCODE
160-2180		12 szt.	pcs.	4 716493 003751	

### Obrotowy wkład QRM-506T/B

- wysokiej jakości taśma korekcyjna do wszystkich typów tuszu
- wkład do korektorów: QRM-506, QAR-506, QJR-506, QDR-506, QBR-506, QCR-506
- opakowanie: blister

5 mm  
6 m

5 lat  
years

INDEKS	INDEX	OPAK.	PKG.	EAN	BARCODE
160-2002		24 szt.	pcs.	4 716493 182425	

### Pivotable refill QRM-506T/B

- high quality correction tape for all ink types
- suitable for: QRM-506, QAR-506, QJR-506, QDR-506, QBR-506, QCR-506
- packaging: blister card



## Korektor w taśmie QFN-506

- super gładkie, mocne krycie
- kieszonkowy: długość 70 mm, średnica 20 mm
- transparentna obudowa pozwala na kontrolę stopnia zużycia taśmy
- każdy korektor posiada indywidualny kod kreskowy



**! wygodny stoik na ladę**  
comfortable desk bar

5 mm  
6 m

5  
lat  
years



INDEKS INDEX

OPAK. PKG.

EAN BARCODE

160-2222

48 szt. pcs.



## Korektor w taśmie z ruchomą końcówką DNL-412

- wysokiej jakości korektor do wszystkich typów tuszu
- stabilizator pozwala na uzyskanie prostej linii taśmy, redukuje efekty niepewnego prowadzenia korektora: łatwe korygowanie pod każdym kątem
- każdy korektor posiada indywidualny kod kreskowy
- transparentna obudowa pozwala na kontrolę stopnia zużycia taśmy
- opakowanie: blister



4,2 mm  
12 m

5  
lat  
years

INDEKS INDEX

OPAK. PKG.

EAN BARCODE

160-1916

12 szt. pcs.



## Korektor w taśmie CT-GN510/B

- wysokiej jakości korektor do wszystkich typów tuszu
- transparentna obudowa pozwala na kontrolę stopnia zużycia taśmy
- posiada regulację napięcia taśmy
- każdy korektor posiada indywidualny kod kreskowy
- opakowanie: blister



5 mm  
10 m

5  
lat  
years

INDEKS INDEX

OPAK. PKG.

EAN BARCODE

160-1876

12 szt. pcs.



## Correction tape QFN-506

- super smooth, strong coverage
- mini size: 70 mm long, diameter 20 mm
- transparent cover enables to control tape use level
- individual barcode

## Correction tape with flexible tip DNL-412

- high quality correction tape for all ink types
- stabilizer enables straight tape line
- easy correction at any angle
- individual barcode
- transparent cover enables to control tape use level
- packaging: blister card

## Correction tape CT-GN510/B

- high quality correction tape for all ink types
- transparent cover enables to control tape use level
- adjustable tape tension
- individual barcode
- packaging: blister card

## Korektory w pisaku

- wysokiej jakości, szybko schnący płyn korygujący
- perfekcyjnie pokrywa korygowaną powierzchnię
- niewidoczny na fotokopiach
- nie zawiera PVC
- każdy korektor posiada indywidualny kod kreskowy

## Correction pens

- high quality correction pen
- quick dry
- excellent coverage of surface
- invisible on photocopies
- contain no PVC
- individual barcode

**oval**<sup>®</sup>

### ZIG-1000

- precyzyjna metalowa końcówka

1,6 mm 7 ml 5 lat years

INDEKS INDEX OPAK. PKG. EAN BARCODE  
160-1816 12 szt. pcs. 4 716493 982322



### ZIG-1000

- precise metal tip

### PA-10

- precyzyjna metalowa końcówka

1,6 mm 7 ml 5 lat years

INDEKS INDEX OPAK. PKG. EAN BARCODE  
160-1783 24 szt. pcs. 4 716493 862327



### PA-10

- precise metal tip

### PQN-10

- wyprofilowana rączka z plastycznego materiału pozwala wygodnie dozować płyn korekcyjny poprzez naciśnięcie
- precyzyjna metalowa końcówka

1,6 mm 7 ml 5 lat years

INDEKS INDEX OPAK. PKG. EAN BARCODE  
160-1977 12 szt. pcs. 4 716493 252326



### PQN-10

- handle made of soft material provides comfortable outflow of correction fluid
- precise metal tip

## Korektory w taśmie

- niewidoczne na fotokopiach
- dobrze pokrywają korygowaną powierzchnię
- transparentna obudowa pozwala na kontrolę stopnia zużycia taśmy
- opakowanie: indywidualne

## Correction tapes

- invisible on photocopies
- excellent coverage of surface
- transparent cover enables to control tape use level
- packaging: individual

### GR-85W z zabezpieczeniem

- kolorowe zasuwane zamknięcie zabezpiecza taśmę



5 mm  
8 m

3  
lata  
years

INDEKS INDEX OPAK. PKG.

160-2012 24 szt. pcs.

EAN BARCODE



### GR-953 z zatyczką

- zatyczka zabezpiecza taśmę



5 mm  
8 m

3  
lata  
years

INDEKS INDEX OPAK. PKG.

160-2138 24 szt. pcs.

EAN BARCODE



### BIN GR-85



5 mm  
8 m

1  
rok  
year

INDEKS INDEX OPAK. PKG.

160-1274 12 szt. pcs.

EAN BARCODE



### BIN GR-85

## Korektory w długopisie

- szybko schnące
- niewidoczne na fotokopiach
- każdy korektor posiada indywidualny kod kreskowy

## Correction pens

- quick dry
- invisible on photocopies
- individual barcode

Grand®

### GR-11M

- precyzyjna metalowa końcówka



INDEKS INDEX OPAK. PKG. EAN BARCODE  
160-1268 12 szt. pcs. 5 903364 253059



### GR-11M

- precise metal tip

### GR-10M

- precyzyjna metalowa końcówka



INDEKS INDEX OPAK. PKG. EAN BARCODE  
160-1928 12 szt. pcs. 5 903364 253097



### GR-10M

- precise metal tip

## Korektor w butelce GR-20

- korektor z pędzelkiem
- szybko schnący
- niewidoczny na fotokopiach
- posiada indywidualny kod kreskowy

## Correction fluid GR-20

- correction fluid with brush
- quick dry
- invisible on photocopies
- individual barcode

Grand®



INDEKS INDEX OPAK. PKG. EAN BARCODE  
160-1266 12 szt. pcs. 5 903364 253011



PRODUKT PRODUCT	SZEROKOŚĆ LINII PISANIA LINE THICKNESS	DLUGOŚĆ PISANIA WRITING LENGTH	TUSZ WODOODPORNY WATERPROOF INK	BAZA TUSZU INK BASE	INDYWIDUALNY KOD INDIVIDUAL BARCODE	PAKOWANIE PACKAGING
✦ GR-2103 wielkopojemnościowy large capacity	0,7 mm	1500 m	✓	alkohol alcohol	✓	display 24
GR-2222 wielkopojemnościowy large capacity	0,7 mm	1000 m	✓	alkohol alcohol	✓	display 24
GR-0651 wielkopojemnościowy large capacity	0,7 mm	1000 m	✓		✓	display 24
GR-535	0,7 mm	800 m	✓		✓	display 24
GR-5801	0,7 mm	790 m	✓		✓	tuba drum 50
GR-5750	0,7 mm	700 m	✓		✓	tuba drum 50
GR-5760	0,7 mm	800 m	✓		✓	tuba drum 50
GR-2051	0,7 mm	1000 m	✓	alkohol alcohol	✓	display 24
GR-2051A	0,7 mm	1000 m	✓	alkohol alcohol	✓	display 24
GR-2108A	0,7 mm	1000 m	✓		✓	display 24
GR-2062	0,7 mm	1000 m	✓	alkohol alcohol	✓	display 24
GR-2057A	0,7 mm	1000 m	✓	alkohol alcohol	✓	display 24
GR-2013	0,7 mm	1000 m	✓	alkohol alcohol	✓	display 24
GR-2078C	0,7 mm	1000 m	✓	alkohol alcohol	✓	display 24
✦ GR-557	0,7 mm	1000 m	✓	alkohol alcohol		display 24
GR-5302	0,7 mm	1000 m	✓		✓	display 24
✦ GR-2055A	0,7 mm	1000 m	✓		✓	display 24
GR-2006A	0,7 mm	1000 m	✓	alkohol alcohol	✓	display 24
✦ WZ-2001	0,7 mm	1000 m	✓	alkohol alcohol		display 24
GR-2102	0,7 mm	700 m	✓		✓	display 24
GR-2115	0,7 mm	700 m	✓		✓	display 24
✦ GR-2033	0,7 mm	700 m				pudełko box 24
GR-2120	0,7 mm	650 m			✓	display 24
GR-2256	0,7 mm	650 m			✓	display 24
Fandy SOLIDLY	0,5 mm	1000 m				pudełko box 12
Koty 199398	0,5 mm	1300 m	✓			display 60
GR-590M	0,7 mm	358 m	✓	olej oil	✓	display 48
GR-5903	1 mm	500 m	✓	olej oil		etui plastic case 4
GR-5332	1 mm	550 m	✓	olej oil	✓	display 24
GR-5256 JETPOINT 0.7	0,7 mm	500 m	✓	olej oil	✓	etui plastic case 4
GR-3608 Touch Pen	0,7 mm	400 m	✓			display 36
GR-879 na sprężynce table ball pen	0,7 mm	500 m	✓	alkohol alcohol		
GR-1609 CORRETTO wymazywalny erasable	0,5 mm	250 m	✓			display 12 / 24
GR-2020	0,7 mm	800 m x 3	✓	alkohol alcohol	✓	display 24
Carioca MAXI	1 mm	1200 m x 10	✓	alkohol alcohol		display 18
Carioca 4 kolory	1 mm	600 m x 4	✓		✓	display 24
GR-F5518 4 kolory	0,5 mm	1030 m x 4			✓	display 24
Koty 4 kolory	0,5 mm	1120 m x 4	✓			display 48
Corvina Classic	1 mm	2000 m	✓	alkohol alcohol		pudełko box 50
Corvina Classic 0.7	0,7 mm	2300 m	✓	alkohol alcohol		pudełko box 50
GR-101 żelowy gel pen	0,5 mm	250 m		woda water		pudełko box 12
Carioca Fiorella	1 mm	2000 m	✓			blister blister card 6 / 10
GR-91-6 FLUO	1 mm	1100 m	✓			etui plastic case 6
GR-F573-12	0,5 mm	500 m				etui plastic case 12
żelowy z brokatem glitter gel pen	1 mm	300 m		woda water		etui plastic case 6 / 12
cienkopis GR-280 fineliner	0,4 mm	500 m				pudełko box 12 etui case 10
cienkopis GR-203 fineliner	0,5 mm	1300 m		woda water		pudełko box 12

✦ pod nadruk – nie posiada żadnych oznaczeń for advertising – no marks

PRODUKT PRODUCT	SZEROKOŚĆ KOŃCÓWKI TIP WIDTH	DLUGOŚĆ PISANIA WRITING LENGTH	TUSZ WODOODPORNY WATERPROOF INK	BAZA TUSZU INK BASE	INDYWIDUALNY KOD INDIVIDUAL BARCODE	PAKOWANIE PACKAGING
zakreślacz GR-225 highlighter	1-4,2 mm	300 m			✓	pudełko box 12 etui case 4
zakreślacz GR-225P highlighter	1-4,2 mm	220 m				etui case 4
zakreślacz fluo GR-219 highlighter	1-3,4 mm	170 m		pigment pigment		etui plastic case 6
zakreślacz w sztyfcie HLD12 highlighter						pudełko box 12 etui case 4
zakreślacz wymazywalny GR-529 highlighter	3,8 mm					pudełko box 10
marker permanentny GR-103C ścięty permanent marker chisel tip	1-4,8 mm	260 m	✓	alkohol alcohol		pudełko box 12
marker permanentny GR-103R okrągły permanent marker round tip	1-3,8 mm	260 m	✓	alkohol alcohol		pudełko box 12
marker do płyt CD/DVD CM-051 CD/DVD marker	0,8 / 3,8 mm		✓	alkohol alcohol		pudełko box 24
marker tablicowy GR-003 whiteboard marker	1-3,8 mm	260 m	✓	alkohol alcohol		pudełko box 12
marker tablicowy Carioca whiteboard marker	1-2,5 mm		✓			pudełko box 12
marker olejowy GR-25 paint marker	1,8-2,8 mm		✓	olej oil		pudełko box 12

## Długopis ECO GR-2006A

- długopis automatyczny z wymiennym wkładem
- wykonany z materiału biodegradowalnego
- tusz wodoodporny
- ergonomiczna obudowa
- display wykonany z materiałów z recyklingu

## Ball pen ECO GR-2006A

- retractable ball pen with replaceable refill
- made of biodegradable material
- waterproof ink
- ergonomic cover
- display box made of recycled materials



INDEKS INDEX OPAK. PKG. EAN BARCODE

160-2230 24 szt. pcs.



# STRAW & FRUIT

## ZE SŁOMY I OWOCÓW





## Długopisy wielkopojemnościowe

- indywidualny kod kreskowy w formie naklejki usuwalnej bez śladu

## Large capacity refill ball pens

- removable sticker with individual barcode

### GR-2103

- automatyczny z wymiennym wkładem
- przeznaczony pod nadruk reklamowy – nie posiada żadnych oznaczeń

0.7 mm

1500 m



**!** długopis pod nadruk bez oznaczeń  
for advertising no marks

INDEKS INDEX OPAK. PKG. EAN BARCODE

\* 160-2085 24 szt. pcs.  5 903364 241773

\* do wyczerpania zapasów while stock lasts

### GR-2103

- retractable with replaceable refill
- for advertising imprint – no marks



### GR-2222

- automatyczny z wymiennym wkładem
- ergonomiczna obudowa

0.7 mm

1000 m



INDEKS INDEX OPAK. PKG. EAN BARCODE

160-2191 24 szt. pcs.  5 903364 241872

### GR-2222

- retractable with replaceable refill
- ergonomic cover



### GR-0651

- automatyczny z wymiennym wkładem
- ergonomiczna metalowa obudowa

0.7 mm

1000 m



INDEKS INDEX OPAK. PKG. EAN BARCODE

\* 160-2189 24 szt. pcs.  5 903364 241858

\* do wyczerpania zapasów while stock lasts

### GR-0651

- retractable with replaceable refill
- ergonomic metal cover



## Długopis GR-535

- automatyczny z wymiennym wkładem
- ergonomiczna obudowa z uchwytem antypoślizgowym



INDEKS INDEX OPAK. PKG. EAN BARCODE

160-2107 24 szt. pcs.

## Ball pen GR-535

- retractable with replaceable refill
- ergonomic cover with non-slip grip



## Długopis GR-5801

- automatyczny z wymiennym wkładem
- ergonomiczna obudowa z uchwytem antypoślizgowym



INDEKS INDEX OPAK. PKG. OBUDOWA COVER EAN BARCODE

160-1985 tuba 50 szt. czarna black  
drum 50 pcs.  
160-2079 tuba 50 szt. pastelowa pastel  
drum 50 pcs.



## Ball pen GR-5801

- retractable with replaceable refill
- ergonomic cover with non-slip grip



## Długopis GR-5750

- automatyczny z wymiennym wkładem
- ergonomiczna obudowa z uchwytem antypoślizgowym
- indywidualny kod kreskowy w formie naklejki usuwalnej bez śladu



INDEKS INDEX KOLOR COLOR OPAK. PKG. EAN BARCODE

160-1925 ● czarny black tuba 50 szt. drum 50 pcs.

160-1911 ● niebieski blue tuba 50 szt. drum 50 pcs.

## Ball pen GR-5750

- retractable with replaceable refill
- ergonomic cover with non-slip grip
- removable sticker with individual barcode



## Długopis GR-5760

- automatyczny z wymiennym wkładem
- indywidualny kod kreskowy w formie naklejki usuwalnej bez śladu



INDEKS INDEX OPAK. PKG. EAN BARCODE

160-1975 tuba 50 szt. drum 50 pcs.

## Ball pen GR-5760

- retractable with replaceable refill
- removable sticker with individual barcode



## Długopis GR-2051

- automatyczny z wymiennym wkładem
- ergonomiczna obudowa z elementami antypoślizgowymi
- indywidualny kod kreskowy w formie naklejki usuwalnej bez śladu



INDEKS INDEX OPAK. PKG. EAN BARCODE

160-1069 24 szt. pcs. 5 903364 241070

## Długopis GR-2051A

- automatyczny z wymiennym wkładem
- ergonomiczna obudowa z elementami antypoślizgowymi
- indywidualny kod kreskowy w formie naklejki usuwalnej bez śladu



INDEKS INDEX OPAK. PKG. EAN BARCODE

★ 160-1070 24 szt. pcs. 5 903364 241094

★ do wyczerpania zapasów while stock lasts

## Długopis GR-2108A

- automatyczny z wymiennym wkładem
- ergonomiczna obudowa z elementami antypoślizgowymi
- indywidualny kod kreskowy w formie naklejki usuwalnej bez śladu



INDEKS INDEX OPAK. PKG. EAN BARCODE

160-1976 24 szt. pcs. 5 903364 241711

## Długopis GR-2062

- automatyczny z wymiennym wkładem
- ergonomiczna obudowa z uchwytem antypoślizgowym
- indywidualny kod kreskowy w formie naklejki usuwalnej bez śladu



INDEKS INDEX OPAK. PKG. EAN BARCODE

★ 160-1770 24 szt. pcs. 5 903364 241193

## Ball pen GR-2051

- retractable with replaceable refill
- ergonomic cover with non-slip elements
- removable sticker with individual barcode



## Ball pen GR-2051A

- retractable with replaceable refill
- ergonomic cover with non-slip elements
- removable sticker with individual barcode



## Ball pen GR-2108A

- retractable with replaceable refill
- ergonomic cover with non-slip elements
- removable sticker with individual barcode



## Ball pen GR-2062

- retractable with replaceable refill
- ergonomic cover with non-slip grip
- removable sticker with individual barcode



★ do wyczerpania zapasów while stock lasts

## Długopis GR-2120

- automatyczny z wymiennym wkładem
- ergonomiczna obudowa z elementami antypoślizgowymi



INDEKS INDEX OPAK. PKG. EAN BARCODE

160-2269 24 szt. pcs. 5 903364 281038

## Długopis GR-2256

- automatyczny z wymiennym wkładem
- ergonomiczna obudowa z elementami antypoślizgowymi



INDEKS INDEX OPAK. PKG. EAN BARCODE

160-2270 24 szt. pcs. 5 903364 281052

## Długopis KOTY 199398

- automatyczny z wymiennym wkładem



INDEKS INDEX OPAK. PKG. EAN BARCODE

160-2253 60 szt. pcs. 8 595083 514770

## Długopis GR-2232

- automatyczny z wymiennym wkładem
- ergonomiczna obudowa z uchwytem antypoślizgowym



INDEKS INDEX OPAK. PKG. EAN BARCODE

160-2231 24 szt. pcs. 5 903364 241940

## Ball pen GR-2120

- retractable with replaceable refill
- ergonomic cover with non-slip elements



Grand®



## Ball pen GR-2256

- retractable with replaceable refill
- ergonomic cover with non-slip elements

Grand®



## Ball pen CATS 199398

- retractable with replaceable refill

Grand®



## Ball pen GR-2232

- retractable with replaceable refill
- ergonomic body with non-slip grip

Grand®



## Długopis WZ-2001

- automatyczny z wymiennym wkładem
- ergonomiczna obudowa z uchwytem antypoślizgowym
- idealny pod nadruk reklamowy – nie posiada żadnych oznaczeń

0,7 mm

1000 m



! długopis pod nadruk bez oznaczeń  
for advertising no marks

INDEKS INDEX OPAK. PKG. EAN BARCODE

160-1774

24 szt. pcs.



## Ball pen WZ-2001

- retractable with replaceable refill
- ergonomic cover with non-slip grip
- for advertising imprint – no marks

Grand®



## Długopis GR-5302

- automatyczny z wymiennym wkładem
- ergonomiczna obudowa z uchwytem antypoślizgowym
- wygodny, trójkątny kształt
- indywidualny kod kreskowy w formie naklejki usuwalnej bez śladu

0,7 mm

1000 m



INDEKS INDEX OPAK. PKG. EAN BARCODE

\* 160-1973

24 szt. pcs.



## Ball pen GR-5302

- retractable with replaceable refill
- ergonomic cover with non-slip grip
- comfortable triangle grip
- removable sticker with individual barcode

Grand®



## Długopis GR-2055A

- automatyczny z wymiennym wkładem
- ergonomiczna obudowa z uchwytem antypoślizgowym
- wygodny, trójkątny kształt
- idealny pod nadruk reklamowy – nie posiada żadnych oznaczeń

0,7 mm

1000 m



! długopis pod nadruk bez oznaczeń  
for advertising no marks

INDEKS INDEX OPAK. PKG. EAN BARCODE

160-1955

24 szt. pcs.



## Ball pen GR-2055A

- retractable with replaceable refill
- ergonomic cover with non-slip grip
- comfortable triangle grip
- for advertising imprint – no marks

Grand®



## Długopis GR-2006A

- automatyczny z wymiennym wkładem
- ergonomiczna obudowa z uchwytem antypoślizgowym
- indywidualny kod kreskowy w formie naklejki usuwalnej bez śladu

0,7 mm

1000 m



INDEKS INDEX OPAK. PKG. EAN BARCODE

160-1072

24 szt. pcs.



## Ball pen GR-2006A

- retractable with replaceable refill
- ergonomic cover with non-slip grip
- removable sticker with individual barcode

Grand®



## Długopis GR-2057A

- automatyczny z wymiennym wkładem
- ergonomiczna obudowa z uchwytem antypoślizgowym
- indywidualny kod kreskowy w formie naklejki usuwalnej bez śladu



INDEKS INDEX OPAK. PKG. EAN BARCODE

160-1066 24 szt. pcs.  5 903364 241018

## Długopis GR-2013

- automatyczny z wymiennym wkładem
- ergonomiczna obudowa z uchwytem antypoślizgowym
- indywidualny kod kreskowy w formie naklejki usuwalnej bez śladu



INDEKS INDEX OPAK. PKG. EAN BARCODE

\* 160-1769 24 szt. pcs.  5 903364 241179

\* do wyczerpania zapasów while stock lasts

## Długopis GR-2078C

- automatyczny z wymiennym wkładem
- ergonomiczna obudowa z uchwytem antypoślizgowym
- indywidualny kod kreskowy w formie naklejki usuwalnej bez śladu



INDEKS INDEX OPAK. PKG. EAN BARCODE

160-1071 24 szt. pcs.  5 903364 241117

## Długopis GR-557

- automatyczny z wymiennym wkładem
- ergonomiczna obudowa z uchwytem antypoślizgowym
- idealny pod nadruk reklamowy – nie posiada żadnych oznaczeń



**długopis pod nadruk bez oznaczeń**  
for advertising no marks

INDEKS INDEX OPAK. PKG. EAN BARCODE

160-1812 24 szt. pcs.  5 903364 239411

## Ball pen GR-2057A

- retractable with replaceable refill
- ergonomic cover with non-slip grip
- removable sticker with individual barcode

Grand®



## Ball pen GR-2013

- retractable with replaceable refill
- ergonomic cover with non-slip grip
- removable sticker with individual barcode

Grand®



## Ball pen GR-2078C

- retractable with replaceable refill
- ergonomic cover with non-slip grip
- removable sticker with individual barcode

Grand®



## Ball pen GR-557

- retractable with replaceable refill
- ergonomic cover with non-slip grip
- for advertising imprint – no marks

Grand®



## Długopis GR-2102

- automatyczny z wymiennym wkładem
- ergonomiczna metalowa obudowa z uchwytem antypoślizgowym



INDEKS INDEX OPAK. PKG. EAN BARCODE

160-2188 24 szt. pcs.  5 903364 241834

## Ball pen GR-2102

Grand®

- retractable with replaceable refill
- ergonomic metal cover with non-slip grip



## Długopis GR-2115

- automatyczny z wymiennym wkładem
- ergonomiczna metalowa obudowa



INDEKS INDEX OPAK. PKG. EAN BARCODE

160-2190 24 szt. pcs.  5 903364 241896

## Ball pen GR-2115

Grand®

- retractable with replaceable refill
- ergonomic metal cover



## Długopis Fandy SOLIDLY

- automatyczny z wymiennym wkładem
- ergonomiczna obudowa z elementami antypoślizgowymi



INDEKS INDEX OPAK. PKG. EAN BARCODE

160-1924 12 szt. pcs.  6 923655 520089

## Ball pen Fandy SOLIDLY

- retractable with replaceable refill
- ergonomic cover with non-slip elements



## Długopisy z wkładem olejowym

Oil ink refill ball pens

Grand®

### GR-590M

- automatyczny z wymiennym wkładem olejowym
- ergonomiczna obudowa z uchwytem antypoślizgowym



INDEKS INDEX OPAK. PKG. EAN BARCODE  
160-2184 48 szt. pcs. 5 903364 280017

### GR-590M

- retractable with replaceable oil refill
- ergonomic cover with non-slip grip



### GR-5903

- automatyczny z wymiennym wkładem olejowym
- ergonomiczna obudowa z elementami antypoślizgowymi
- 4 kolory w plastikowym etui



INDEKS INDEX ZESTAW SET EAN BARCODE  
160-2109 4 kol. col. 5 903364 262624

### GR-5903

- retractable with replaceable oil refill
- ergonomic cover with non-slip elements
- 4 colors in plastic case



### GR-5332

- automatyczny z wymiennym wkładem olejowym
- ergonomiczna obudowa z uchwytem antypoślizgowym
- indywidualny kod kreskowy w formie naklejki usuwalnej bez śladu



INDEKS INDEX OPAK. PKG. EAN BARCODE  
160-2127 24 szt. pcs. 5 903364 262785

### GR-5332

- retractable with replaceable oil refill
- ergonomic cover with non-slip grip
- removable sticker with individual barcode





## Długopis GR-5256 JETPOINT 0.7

- automatyczny z wymiennym wkładem olejowym
- ergonomiczna obudowa z uchwytem antypoślizgowym
- indywidualny kod kreskowy w formie naklejki usuwalnej bez śladu



INDEKS INDEX OPAK. PKG. EAN BARCODE

160-1986 24 szt. pcs.  5 903364 262129

## Ball pen GR-5256 JETPOINT 0.7

- retractable with replaceable oil refill
- ergonomic cover with non-slip grip
- removable sticker with individual barcode



Grand®

## Długopis GR-3608 Touch Pen

- metalowy długopis z wymiennym wkładem
- posiada gumkę do pracy na ekranach dotykowych



INDEKS INDEX OPAK. PKG. EAN BARCODE

160-1994 36 szt. pcs.  5 903364 241742

## Touch pen GR-3608

- metal ball pen with replaceable refill
- with rubber for touch screens

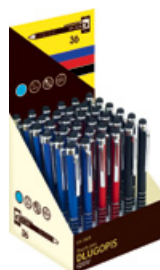

Grand®

## Długopis GR-879 na sprężynce

- plastikowa sprężynka
- leżący lub stojący
- przylepna podstawa



INDEKS INDEX OPAK. PKG. EAN BARCODE

160-1813 25 szt. pcs.  5 903364 240264

## Table ball pen GR-879

- plastic spring
- horizontal or vertical
- adhesive base



Grand®

## Długopis Corvina Classic

- z wymiennym wkładem
- przezroczysta obudowa ABS umożliwia kontrolę stopnia zużycia wkładu
- mosiężna kulka pisząca
- zatyczka w kolorze wkładu



## Ball pen Corvina Classic

- with replaceable refill
- transparent ABS cover enables to control ink use level
- brass writing roller
- pin in refill color



INDEKS INDEX	KOLOR COLOR	OPAK. PKG.	EAN BARCODE
160-1402	● czarny black	50 szt. pcs.	8 003511 411633
160-1403	● czerwony red	50 szt. pcs.	8 003511 431624
160-1404	● niebieski blue	50 szt. pcs.	8 003511 421632
160-1405	● zielony green	50 szt. pcs.	8 003511 441630



INDEKS INDEX	KOLOR COLOR	OPAK. PKG.	EAN BARCODE
160-2156	● czarny black	50 szt. pcs.	8 003511 413835
160-2157	● czerwony red	50 szt. pcs.	8 003511 433833
160-2158	● niebieski blue	50 szt. pcs.	8 003511 423834
160-2159	● zielony green	50 szt. pcs.	8 003511 443832

## Długopis GR-2033

- z wymiennym wkładem
- ergonomiczna obudowa
- idealny pod nadruk reklamowy – nie posiada żadnych oznaczeń

## Ball pen GR-2033

- with replaceable refill
- ergonomic cover
- for advertising imprint – no marks



! **długopis pod nadruk bez oznaczeń**  
for advertising no marks

INDEKS INDEX	KOLOR COLOR	OPAK. PKG.	EAN BARCODE
160-2263	● czarny black	24 szt. pcs.	5 903364 241988
160-2264	● niebieski blue	24 szt. pcs.	5 903364 242008



# corretto®

## Długopis wymazywalny CORRETTO GR-1609

## Erasable ball pen CORRETTO GR-1609

- długopis z wymiennym wkładem
- wymazywanie za pomocą gumki na końcu długopisu lub zatyczce
- tusz znika także po podgrzaniu kartki

- ball pen with replaceable refill
- erase with rubbers on top and on cap of the pen, or by heating the sheet of paper



**! nowa formuła**  
new formula



### blister

- z dodatkowym wkładem

### blister card

- with extra refill





### display

### display



INDEKS INDEX	KOLOR COLOR	OPAK. PKG.	EAN BARCODE
160-2160	● niebieski blue	12 szt. pcs.	

INDEKS INDEX	KOLOR COLOR	OPAK. PKG.	EAN BARCODE
160-2154	● czarny black	24 szt. pcs.	
160-2155	● niebieski blue	24 szt. pcs.	



## Długopis Carioca MAXI

**CARIOCA**

- stworzony z myślą o dzieciach
- automatyczny
- 10 różnokolorowych wkładów
- wykonany z ABS
- jaskrawe, transparentne kolory obudowy
- opakowanie: blister

### Ball pen Carioca MAXI

- designed for children
- retractable
- 10 colors of refills
- made of ABS
- vivid transparent cover
- packaging: blister card



INDEKS INDEX OPAK. PKG. EAN BARCODE

160-1410 18 szt. pcs. 8 003511 415006

## Długopis 4 kolory

**CARIOCA**

- automatyczny
- 4 wkłady
- ergonomiczna obudowa z uchwytem antypoślizgowym
- indywidualny kod kreskowy w formie naklejki usuwalnej bez śladu

### Ball pen 4 colors

- retractable
- 4 colors of refills
- ergonomic cover with non-slip grip
- removable sticker with individual barcode

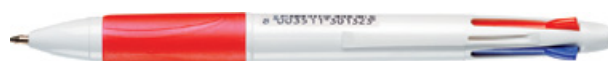

INDEKS INDEX OPAK. PKG. EAN BARCODE

160-2266 24 szt. pcs. 8 003511 301323

## Długopis GR-2020 3 kolory

**Grand**

- automatyczny
- 3 wkłady
- ergonomiczna obudowa z uchwytem antypoślizgowym
- indywidualny kod kreskowy w formie naklejki usuwalnej bez śladu

### Ball pen GR-2020 3 colors

- retractable
- 3 refills
- ergonomic cover with non-slip grip
- removable sticker with individual barcode



INDEKS INDEX OPAK. PKG. EAN BARCODE

\* 160-1068 24 szt. pcs. 5 903364 241056

\* do wyczerpania zapasów while stock lasts

## Długopis 4 kolory KOTY

- automatyczny z wymiennym wkładem

### Ball pen 4 colors CATS

- retractable with replaceable refill



INDEKS INDEX OPAK. PKG. EAN BARCODE

160-2254 48 szt. pcs. 6 930126 706231



## Długopis GR-F5518 4 kolory

- automatyczny
- 4 wkłady
- ergonomiczna obudowa z uchwytem antypoślizgowym

## Ball pen GR-F5518 4 colors

- retractable
- 4 refills
- ergonomic cover with non-slip grip



INDEKS INDEX OPAK. PKG. EAN BARCODE

160-2267

24 szt. pcs.

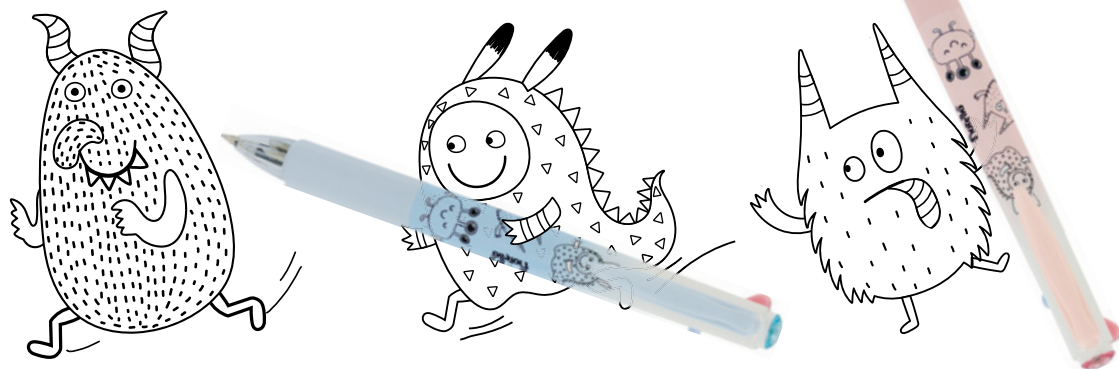

## Długopis żelowy GR-101

- z wymiennym wkładem
- ergonomiczna obudowa z uchwytem antypoślizgowym
- przezroczysta obudowa umożliwia kontrolę stopnia zużycia wkładu
- skuwka w kolorze wkładu

## Gel pen GR-101

- with replaceable refill
- ergonomic cover with non-slip grip
- transparent cover enables to control ink use level
- pin in refill color



INDEKS INDEX KOLOR COLOR OPAK. PKG. EAN BARCODE

160-1025

● czarny black

12 szt. pcs.



160-1026

● czerwony red

12 szt. pcs.



160-1027

● niebieski blue

12 szt. pcs.



160-1028

● zielony green

12 szt. pcs.



## Długopis Fiorella

- fluorescencyjny tusz
- transparentna obudowa i zatyczka w jaskrawym kolorze wkładu
- mosiężna kulka pisząca



INDEKS	INDEX	ZESTAW SET	EAN BARCODE
160-1407	6 kol.	col.	8 003511 427740
160-1409	10 kol.	col.	8 003511 427757

## Długopis GR-91-6 FLUO

- fluorescencyjny tusz
- transparentna obudowa, zatyczka w jaskrawym kolorze wkładu



INDEKS	INDEX	ZESTAW SET	EAN BARCODE
160-2011	6 szt.	pcs.	5 903364 262334

## Długopis żelowy GR-F573-12

- neonowe kolory
- z wymiennym wkładem



INDEKS	INDEX	ZESTAW SET	EAN BARCODE
160-2140	12 kol.	col.	5 903364 241810

## Długopis żelowy z brokatem

- długopis żelowy z brokatowym tuszem
- przezroczysta obudowa umożliwi kontrolę stopnia zużycia wkładu
- skuwka w kolorze wkładu



INDEKS	INDEX	ZESTAW SET	EAN BARCODE
160-1810	6 kol.	col.	5 903364 240301
160-2196	12 kol.	col.	5 903364 280048

## Ball pen Fiorella

- fluo ink
- transparent cover and pin in vivid color of refill
- brass writing roller



## Ball pen GR-91-6 FLUO

- fluorescent ink
- transparent cover enables to control ink use level

Grand®



## Gel pen GR-F573-12

- neon colors
- with replaceable refill

fiorella®



## Glitter gel pen

- gel pen with glitter ink
- transparent cover enables to control ink use level
- pin in refill color

fiorella®





wkład GR-W1

refill GR-W1

- przeznaczony do długopisów:
- for ball pens:  
GR-2051, GR-2051A, GR-2078C, GR-2057A,  
GR-2006A, GR-2013, GR-2060A, GR-2062, GR-2067,  
GR-2067A, GR-587, GR-557, GR-5302, GR-5750,  
GR-5760, GR-2052A, GR-2055A, GR-2108A,  
GR-535, GR-2102, GR-2115



INDEKS INDEX	KOLOR COLOR	OPAK. PKG.	EAN BARCODE
160-1901	● czarny black	5 szt. pcs.	5 903364 241667
160-1900	● niebieski blue	5 szt. pcs.	5 903364 241650



do długopisu HERB

- foliowane pojedynczo, pakowane po 12 szt.

refill HERB

- individually foiled, 12 pcs. welded



INDEKS INDEX	OPAK. PKG.	EAN BARCODE
160-1514	120 szt. pcs.	5 903364 245153

wkład GR-Z1

- wkład wielkopojemnościowy
- metalowa obudowa

refill GR-Z1

- large capacity refill
- metal cover

- do długopisów:
- for ball pens:  
GR-2101, GR-538M, GR-2222,  
GR-0651, GR-2103



INDEKS INDEX	OPAK. PKG.	EAN BARCODE
160-1833	2 szt. pcs.	5 903364 240622



wkład GR-Z2

- wkład wielkopojemnościowy
- plastikowa obudowa

refill GR-Z2

- large capacity refill
- plastic cover

- do długopisów:
- for ball pens:  
GR-2101, GR-538M, GR-2222,  
GR-0651, GR-2103



INDEKS INDEX	KOLOR COLOR	OPAK. PKG.	EAN BARCODE
160-2055	● czarny black	2 szt. pcs.	5 903364 241766
160-1883	● niebieski blue	2 szt. pcs.	5 903364 241698



## Wkłady do długopisu wymazywalnego GR-1609

Eraseable ball pen  
GR-1609 refills

corretto®



INDEKS INDEX	KOLOR COLOR	OPAK. PKG.	EAN BARCODE
160-2176	● czarny black	2 szt. pcs.	
160-2177	● niebieski blue	2 szt. pcs.	



## Wkłady do długopisów żelowych

Gel pen refills

Grand®

### do GR-161

- końcówka zabezpieczona przed wyschnięciem

for GR-161

- tip protected from drying



### do GR-101

- końcówka zabezpieczona przed wyschnięciem

for GR-101

- tip protected from drying



INDEKS INDEX	KOLOR COLOR	OPAK. PKG.	EAN BARCODE
* 160-1839	● czarny black	100 szt. pcs.	

\* do wyczerpania zapasów while stock lasts



INDEKS INDEX	KOLOR COLOR	OPAK. PKG.	EAN BARCODE
* 160-1488	● czarny black	100 szt. pcs.	
* 160-1489	● czerwony red	100 szt. pcs.	
* 160-1490	● niebieski blue	100 szt. pcs.	

\* do wyczerpania zapasów while stock lasts

## Grafity do ołówków automatycznych

- 12 grafitów w fiolce / 60 mm



INDEKS INDEX	GRAFIT LEAD	EAN BARCODE
160-1125	0,5 mm	
160-1124	0,7 mm	

Mechanical pencil graphites

- 12 graphites in vial / 60 mm

Grand®





## Ołówki automatyczne

- z gumką
- na grafity 0,5 mm
- ergonomiczna obudowa z uchwytem antypoślizgowym
- indywidualny kod kreskowy w formie naklejki usuwalnej bez śladu

### GR-123

0,5 mm

INDEKS INDEX OPAK. PKG. EAN BARCODE  
160-1861 24 szt. pcs. 5 903364 241407



### GR-113

0,5 mm

INDEKS INDEX OPAK. PKG. EAN BARCODE  
160-2086 24 szt. pcs. 5 903364 241797

## Ołówek stolarski T07

- lakierowany

HB

INDEKS INDEX OPAK. PKG. EAN BARCODE  
160-1377 12 szt. pcs. 5 903364 252038

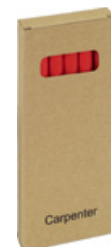

## Mechanical pencils

- with eraser
- for graphites 0.5 mm
- ergonomic cover with non-slip grip
- removable sticker with individual barcode

Grand®

## Carpenter pencil T07

- lacquered

Grand®

## Ołówek z gumką GR-Q3

- wykonany z wysokogatunkowego drewna
- ciemnoczarny, wysokiej jakości grafit
- łatwy do temperowania
- odporny na złamania
- nie zawiera drewna pochodzącego z lasów deszczowych



INDEKS INDEX OPAK. PKG. EAN BARCODE

\* 160-2116 72 szt. pcs.  5 903364 276531

\* do wyczerpania zapasów while stock lasts

## Pencil with eraser GR-Q3

- made of high quality wood
- dark black, high quality lead
- easy to sharpen
- breaking resistant
- does not contain rainforest wood

Grand®



## Ołówek 6602

- lakierowany



INDEKS INDEX OPAK. PKG. EAN BARCODE

160-1764 12 szt. pcs.  5 903364 230531

## Pencil 6602

- lacquered

Grand®



## Ołówek z diamentkami

- wykonany z drewna zabarwionego na czarny kolor
- indywidualny kod kreskowy



INDEKS INDEX OPAK. PKG. EAN BARCODE

160-2274 48 szt. pcs.  5 903364 277024

## Pencil with diamonds

- made of black dyed wood
- individual barcode

Grand®

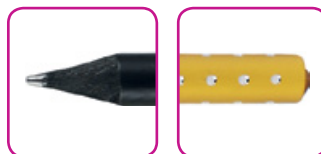

## Ołówek tęczy

- wykonany z drewna zabarwionego na czarny kolor, foliowany kolorowo
- indywidualny kod kreskowy



INDEKS INDEX OPAK. PKG. EAN BARCODE

160-2275 48 szt. pcs.  5 903364 284039

## Rainbow pencil

- made of black dyed wood
- covered with color foil
- individual barcode

Grand®

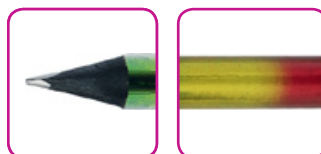

## Ołówek techniczny

- lakierowany
- ostrzony

### Technical pencil

- lacquered
- sharpened



INDEKS INDEX	TWARDOŚĆ HARDNESS	OPAK. PKG.	EAN BARCODE
160-1353	6B	12 szt. pcs.	5 903364 245436
160-1352	5B	12 szt. pcs.	5 903364 245412
160-1350	4B	12 szt. pcs.	5 903364 245399
160-1348	3B	12 szt. pcs.	5 903364 245373
160-1346	2B	12 szt. pcs.	5 903364 244477
160-1354	B	12 szt. pcs.	5 903364 244514
160-1356	HB	12 szt. pcs.	5 903364 244552
160-1355	H	12 szt. pcs.	5 903364 244538
160-1347	2H	12 szt. pcs.	5 903364 244491
160-1349	3H	12 szt. pcs.	5 903364 246013
160-1351	4H	12 szt. pcs.	5 903364 246037

## Zestaw ołówków technicznych

- metalowe pudełko
- zestaw 12 szt. o twardości grafitu: 6H, 4H, 3H, 2H, H, HB, 6B, 5B, 4B, 3B, 2B, B

### Technical pencils set

- metal box
- set 12 pcs., hardness: 6H, 4H, 3H, 2H, H, HB, 6B, 5B, 4B, 3B, 2B, B



INDEKS INDEX	EAN BARCODE
160-1619	5 903364 244712

## Cienkopis klasyczny GR-280

- końcówka fibrowa oprawiona w metal
- tusz na bazie wody

### Fineliner GR-280

- fiber tip enclosed in metal
- water-based ink



INDEKS INDEX	KOLOR COLOR	OPAK. PKG.	EAN BARCODE
160-1871	● czarny black	12 szt. pcs.	5 903364 240356
160-1872	● czerwony red	12 szt. pcs.	5 903364 240417
160-1873	● niebieski blue	12 szt. pcs.	5 903364 240370
160-1874	● zielony green	12 szt. pcs.	5 903364 240394

## Cienkopis klasyczny GR-280 10 kolorów

### Fineliner GR-280 set of 10 colors



INDEKS INDEX	EAN BARCODE
160-1979	5 903364 262044

## Cienkopis kulkowy GR-203

- końcówka kulkowa
- tusz na bazie wody

## Roller pen GR-203

- roller tip
- water-based ink

Grand®



INDEKS	INDEX	KOLOR	COLOR	OPAK.	PKG.	EAN	BARCODE
160-1032		● czarny	black	12 szt.	pcs.	5 903364	239657
160-1033		● czerwony	red	12 szt.	pcs.	5 903364	239893
160-1034		● niebieski	blue	12 szt.	pcs.	5 903364	239688
160-1035		● zielony	green	12 szt.	pcs.	5 903364	239749



## Pióro STILO

- wysokiej jakości pióro na naboje
- stalówka ze stali nierdzewnej
- zapewnia gładkie, miękkie pisanie
- obudowa w neonowych kolorach, ozdobiona srebrnymi geometrycznymi wzorami
- do każdego pióra nabój GRATIS

## Fountain pen STILO

- high quality fountain pen with cartridges
- stainless steel nib
- soft, smooth writing
- cover in neon colors with silver geometrical patterns
- cartridge included

CARIOCA®

INDEKS	INDEX	OPAK.	PKG.	EAN	BARCODE
160-1460		24 szt.	pcs.	8 003511	423049



## Pióro Primary

- wysokiej jakości pióro na naboje
- specjalna okrągła końcówka ze stali nierdzewnej zapewnia wyjątkowo gładkie i miękkie pisanie
- transparentna kolorowa obudowa
- zawiera nabój

## Fountain pen Primary

- high quality fountain pen
- stainless steel roller point provides exceptionally smooth and soft writing
- transparent colored cover
- cartridge included

CARIOCA®

INDEKS	INDEX	OPAK.	PKG.	EAN	BARCODE
160-2163		24 szt.	pcs.	8 003511	415570



## Naboje do piór

- atrament na bazie wody – możliwość wymazania wymazywaczem

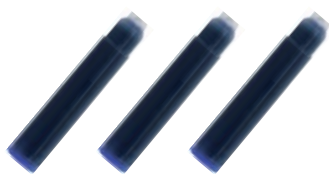

INDEKS INDEX	KOLOR COLOR	OPAK. PKG.	EAN BARCODE
160-1339	● czarny black	100 szt. pcs.	5 907464 200142
160-1340	● niebieski blue	100 szt. pcs.	5 907464 200159



## Pen cartridges

- water-based ink – possible to erase with pen eraser

## Atrament HERO

- wysokiej jakości, trwały atrament do piór wiecznych
- zawiera opóźniacz utleniania i korozji
- bez osadów
- opakowanie szklane
- kolor niebieski – wymazywalny

50 ml



INDEKS INDEX	KOLOR COLOR	OPAK. PKG.	EAN BARCODE
160-1001	● czarny black	12 szt. pcs.	5 903364 244354
160-1002	● granatowy navy blue	12 szt. pcs.	5 903364 244392
160-1003	● niebieski blue	12 szt. pcs.	5 903364 244378

## HERO ink

- high quality durable ink for fountain pen
- contains oxidation and corrosion retardant
- no sediment
- glass bottle
- blue color – erasable



## Pisak wymazywalny No Problem

- pisanie i poprawianie cienką niebieską końcówką
- wymazywanie szeroką białą końcówką
- system SCR: napisz, wymaż, napisz ponownie
- tusz na bazie wody

## Erasable pen No Problem

- writing and rewriting with narrow blue tip
- erasing with wide white tip
- SCR system: write, correct, rewrite
- water-based ink



0,7 mm 4,5 mm

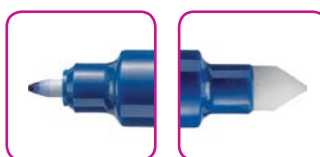

INDEKS INDEX	OPAK. PKG.	EAN BARCODE
160-1484	12 szt. pcs.	8 003511 416119



## Wymazywacz do atramentu INKiller

- wymazywanie atramentu szeroką białą końcówką
- poprawianie cienką niebieską końcówką

## Ink eraser INKiller

- ink erasing with wide white tip
- rewriting with narrow blue tip



0,7 mm 1-4 mm



INDEKS INDEX	OPAK. PKG.	EAN BARCODE
160-2162	50 szt. pcs.	8 003511 414146

## Zakreślacz GR-225

- wysokiej jakości zakreślacz
- ścięta końcówka
- pakowany po 12 szt. lub w zestawie 4 kol.



INDEKS INDEX	KOLOR COLOR	OPAK. PKG.
160-1517	niebieski blue	12 szt. pcs.
160-1518	pomarańczowy orange	12 szt. pcs.
160-1519	różowy pink	12 szt. pcs.
160-1520	zielony green	12 szt. pcs.
160-1521	żółty yellow	12 szt. pcs.

## Highlighter GR-225

- high quality highlighter
- chisel tip
- packed in 12 pcs. box or in 4-color set



EAN BARCODE



## Zakreślacz GR-225 4 kolory

Highlighter GR-225  
set of 4 colors



INDEKS INDEX	ZESTAW SET	EAN BARCODE
160-1722	4 kol. col.	5 903364 240165

## Zakreślacz GR-225P 4 kolory pastelowe

Highlighter GR-225P  
set of 4 pastel colors



INDEKS INDEX	ZESTAW SET	EAN BARCODE
160-2183	4 kol. col.	5 903364 262990

## Zakreślacz fluo GR-219

- tusz pigmentowy
- jaskrawe kolory
- przezroczysta obudowa pozwala na kontrolę stopnia zużycia tuszu
- ścięta końcówka



INDEKS INDEX	ZESTAW SET	EAN BARCODE
160-1881	6 kol. col.	5 903364 239510

## Fluorescent highlighter GR-219

- pigment-based ink
- vivid colors
- transparent cover enables to control ink use level
- chisel tip



## Zakreślacz w sztyfcie HLD12

- transparentny grafit żelowy o grubości ok. 10 mm
- wykręcany sztyft
- łatwa aplikacja na różnych typach atramentu
- nie rozmazuje zakreślanego tekstu odręcznego ani wydruków
- nie przesiąka przez papier
- nie powoduje marszczenia papieru
- **pozostawiony bez zatyczki nie wysycha**
- jednolity, fluorescencyjny kolor
- możliwe ostrzenie nożykiem
- niezwykle gładkie i ciche zakreślanie
- może być używany jako fluorescencyjna kredka
- niewidoczny na fotokopiach

## Dry highlighter HLD12

- transparent lead ca. 10mm diameter
- twist-up
- no blurring of highlighted text
- easy use on various ink types
- no sinking through any paper
- no wrinkles on paper
- **no drying out when left open**
- consistent fluorescent color
- possible sharpening with knife
- smooth and quiet highlighting
- may be also used as fluorescent crayon
- invisible on photocopies



INDEKS INDEX	KOLOR COLOR	OPAK. PKG.	EAN BARCODE
160-1949	● pomarańczowy orange	12 szt. pcs.	8 802946 505685
160-1950	● różowy pink	12 szt. pcs.	8 802946 505692
160-1948	● zielony green	12 szt. pcs.	8 802946 506715
160-1951	● żółty yellow	12 szt. pcs.	8 802946 505678
160-2265	4 kol. col.	blister b/c	8 802946 508075
★ 160-1961	4 kol. col.	pudełko box	8 802946 505791

★ do wyczerpania zapasów while stock lasts

## Zakreślacze pastelowe

- wysokiej jakości zakreślacze
- do pisania na wszystkich rodzajach papieru
- modne pastelowe kolory delikatnie podkreślą ważne treści w dokumentach czy notatkach
- obudowa z elementami antypoślizgowymi

## Pastel highlighters

- high quality highlighters
- perfect on all types of paper
- pastel colors gently emphasize important content in documents or notes
- casing with non-slip parts



INDEKS INDEX	ZESTAW SET	EAN BARCODE
160-2224	6 kol. col.	8 003511 430337

## Zakreślacz w sztyfcie CANDY HLC

- grafit żelowy o grubości ok. 10 mm
- wykręcany sztyft
- łatwa aplikacja na różnych typach atramentu
- nie rozmazuje zakreślanego tekstu odręcznego ani wydruków
- nie przesiąka przez papier
- nie powoduje marszczenia papieru
- **pozostawiony bez zatyczki nie wysycha**
- jednolity, pastelowy kolor
- możliwe ostrzenie nożykiem
- niezwykle gładkie i ciche zakreślanie
- może być używany jako pastelowa kredka
- niewidoczny na fotokopiach
- opakowanie: 12 szt. lub blister 4 kol.

## Dry highlighter CANDY HLC

- lead ca. 10mm diameter
- twist-up
- no blurring of highlighted text
- easy use on different ink types
- no sinking through any paper
- no wrinkles on paper
- **no drying out when left open**
- consistent pastel color
- possible sharpening with knife
- smooth and quiet highlighting
- can be also used as pastel color crayon
- invisible on photocopies
- packaging: 12 pcs. or blister card 4 col.

AMOS®

INDEKS INDEX	KOLOR COLOR	EAN BARCODE
160-2257	miętowy emerald green	8 802946 511990
160-2258	turkusowy aqua blue	8 802946 512010
160-2259	lawendowy lavender violet	8 802946 512027
160-2260	róż pudrowy milky pink	8 802946 512003
160-2261	4 kol. col.	8 802946 512034



## Zakreślacze GR-502P mini pastelowe

- wysokiej jakości zakreślacz
- pastelowe kolory
- tylko 73 mm długości
- opakowanie: stoik 30 szt.

## Highlighters GR-502P mini pastel

- high quality highlighters
- pastel colors
- only 73 mm long
- packaging: jar 30 pcs.

Grand®

**! wygodny stoik na ladę**  
comfortable desk bar



INDEKS INDEX	ZESTAW SET	EAN BARCODE
160-2237	6 kol. col.	5 903364 280055









## Marker tablicowy GR-003

- do tablic suchościernych
- wodoodporny tusz na bazie alkoholu
- okrągła końcówka

## Whiteboard marker GR-003

- waterproof, alcohol-based ink
- rounded tip



INDEKS INDEX	KOLOR COLOR	OPAK. PKG.	EAN BARCODE
160-1308	● czarny black	12 szt. pcs.	 5 903364 240349
160-1309	● czerwony red	12 szt. pcs.	 5 903364 240316
160-1310	● niebieski blue	12 szt. pcs.	 5 903364 240332
160-1311	● zielony green	12 szt. pcs.	 5 903364 240325



## Markery tablicowe

- do tablic suchościernych
- szybkoschnący, ścieralny tusz na bazie alkoholu
- okrągła końcówka o grubości 2,8 mm
- zestaw 4 kol.

## Whiteboard markers

- fast-drying, alcohol-based ink
- rounded tip 2,8mm thick
- set 4 col.



INDEKS INDEX	ZESTAW SET	EAN BARCODE
160-2175	4 kol. col.	 8 003511 432317

## Markery permanentne GR-103C / GR-103R

- niezmywalny tusz na bazie alkoholu
- do większości powierzchni

## Permanent markers GR-103C / GR-103R

- waterproof, alcohol-based ink
- for most surfaces

Grand®



### GR-103C

- końcówka ścięta

### GR-103C

- chisel tip

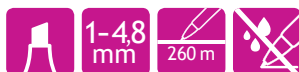

### GR-103R

- końcówka okrągła

### GR-103R

- rounded tip



INDEKS INDEX	KOLOR COLOR	OPAK. PKG.	EAN BARCODE	INDEKS INDEX	KOLOR COLOR	OPAK. PKG.	EAN BARCODE
160-1312	● czarny black	12 szt. pcs.	5 903364 240189	160-1316	● czarny black	12 szt. pcs.	5 903364 240226
160-1313	● czerwony red	12 szt. pcs.	5 903364 240219	160-1317	● czerwony red	12 szt. pcs.	5 903364 240257
160-1314	● niebieski blue	12 szt. pcs.	5 903364 240196	160-1318	● niebieski blue	12 szt. pcs.	5 903364 240233
160-1315	● zielony green	12 szt. pcs.	5 903364 240202	160-1319	● zielony green	12 szt. pcs.	5 903364 240240

## Marker do płyt CD/DVD CM-051

- przeznaczony do gładkich powierzchni
- wodoodporny, niezmywalny
- dwustronna końcówka

## CD/DVD marker CM-051

- for smooth surfaces
- waterproof, indelible
- two-sided

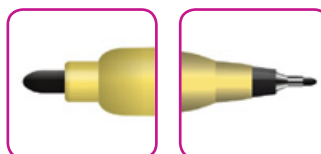

INDEKS INDEX	KOLOR COLOR	OPAK. PKG.	EAN BARCODE
160-1878	● czarny black	24 szt. pcs.	6 930126 705104
160-2272	● czerwony red	24 szt. pcs.	5 903364 280338
160-2273	● niebieski blue	24 szt. pcs.	5 903364 280314



## Marker olejowy GR-25

- wodoodporny, szybkoschnący tusz olejowy
- nieblaknący, odporny na ścieranie
- zastosowanie: stal, guma, drewno, plastik, szkło itp.
- okrągła końcówka fibrowa
- końcówka efektywnie pompująca tusz
- opak. 12 szt.

## Paint marker GR-25

- waterproof, quick-dry oil ink
- fade-proof, wear resistant
- for steel, rubber, wood, plastic, glass etc.
- rounded fibre tip
- efficient pumping tip
- box 12 pcs.



**BRUDNE POWIERZCHNIE**  
DIRTY SURFACE



**STAL**  
STEEL



**GUMA**  
RUBBER



**DREWNO**  
WOOD



**KAMIEŃ**  
STONE



**CERAMIKA, SZKŁO**  
GLASS, PORCELAIN

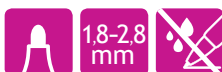

INDEKS INDEX	KOLOR COLOR	OPAK. PKG.	EAN BARCODE
160-1962	○ biały white	12 szt. pcs.	5 903364 240929
160-1963	● czarny black	12 szt. pcs.	5 903364 240745
160-1964	● czerwony red	12 szt. pcs.	5 903364 240868
* 160-2009	● fioletowy violet	12 szt. pcs.	5 903364 262303
160-1965	● niebieski blue	12 szt. pcs.	5 903364 240776
* 160-2008	● pomarańczowy orange	12 szt. pcs.	5 903364 262327
160-1967	● zielony green	12 szt. pcs.	5 903364 240837
160-1969	● żółty yellow	12 szt. pcs.	5 903364 240950
160-1966	● srebrny silver	12 szt. pcs.	5 903364 240899
160-1968	● złoty gold	12 szt. pcs.	5 903364 240806

\* do wyczerpania zapasów while stock lasts

**creative plasticzne**



fiorello®



kupując, wspierasz  
program dożywiania dzieci  
[www.pajacyk.pl](http://www.pajacyk.pl)

pah

## Kredki ołówkowe trójkątne Super Soft

- ostrzone
- przekrój trójkątny
- długość 17,8 cm
- lakierowane
- bardzo miękki grafit
- intensywne kolory
- praktyczne opakowanie
  - po otwarciu wygodny dostęp do kredek
- każda kredka posiada nadruk i lakierowaną końcówkę

## Triangular color pencils Super Soft

- sharpened
- triangular cross-section
- 17,8 cm long
- lacquered
- extra soft lead
- vivid colors
- convenient box
  - easy access to pencils
- every pencil with imprint and lacquered ending

## Kredki Super Soft

- lakierowana końcówka
- długość 17,8 cm

## Super Soft color pencils

- lacquered ending
- 17,8 cm long



36 kol. col.



INDEKS INDEX	ZESTAW SET	EAN BARCODE
170-2186	6 kol. col.	
170-2150	12+2 kol. col.	
170-2187	18 kol. col.	
170-2188	24 kol. col.	
170-2474	36 kol. col.	

## w metalowym etui

- lakierowana końcówka
- długość 17,8 cm

## in metal case

- lacquered ending
- 17,8 cm long



INDEKS	INDEX	ZESTAW	SET	EAN	BARCODE
170-2425	12 kol.	col.		5 903364 277031	
170-2473	24 kol.	col.		5 903364 277307	



## Jumbo

- lakierowana końcówka
- długość 17,8 cm

## Jumbo

- lacquered ending
- 17,8 cm long

INDEKS	INDEX	ZESTAW	SET	EAN	BARCODE
170-2218	12 kol.	col.		5 903364 258962	



inspiracje plastyczne  
creative ideas

[www.fiorelki.pl](http://www.fiorelki.pl)

fiorelloPolska



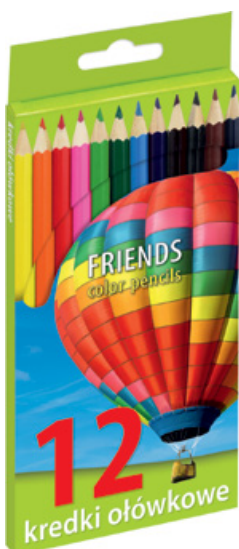

## Kredki ołówkowe sześciokątne

- ostrzone
- długość 17,5 cm
- lakierowane
- miękki grafit
- intensywne kolory



## Hexagonal color pencils

- sharpened
- 17,5 cm long
- lacquered
- soft lead
- vivid colors

INDEKS INDEX	ZESTAW SET	EAN BARCODE
170-1379	6 kol. col.	5 903364 244996
170-1373	12 kol. col.	5 903364 245627
170-2207	18 kol. col.	5 903364 258573
170-1377	24 kol. col.	5 903364 244958
dwustronne, nieostrzone two-sided, not sharpened		
170-1375	12 szt./24 kol. 12 pcs./24 col.	5 903364 244972



## Kredki ołówkowe JUMBO

- ostrzone
- długość 17,5 cm
- lakierowane
- miękki grafit
- intensywne kolory



## Color pencils JUMBO

- sharpened
- 17,5 cm long
- lacquered
- soft lead
- vivid colors

INDEKS INDEX	ZESTAW SET	EAN BARCODE
170-1370	12 kol. col.	5 903364 245450

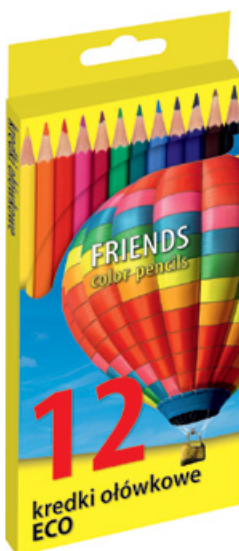

## Kredki ołówkowe ECO

- lakierowane
- miękki grafit
- łatwe do ostrzenia
- bezdrzewne



## Color pencils ECO

- lacquered
- soft lead
- easy to sharpen
- woodless

INDEKS INDEX	ZESTAW SET	EAN BARCODE
170-2302	12 kol. col.	5 903364 276331

## Kredki Multikolor

- ostrzone
- miękkie
- przekrój trójkątny
- średnica wkładu 5,4 mm Jumbo
- wkład: żółto-czerwono-niebieski
- wiele kolorów kreski w zależności od nachylenia i obrotu kredki
- każda kredka posiada nadrukowany kod kreskowy
- opakowanie 12 szt. w tubie

INDEKS INDEX OPAK. PKG. EAN BARCODE

★ 170-2299 12 szt. pcs.  5 903364 276317

★ do wyczerpania zapasów while stock lasts

## Color pencil Multikolor

- sharpened
- soft
- triangular cross-section
- lead diameter 5,4 mm Jumbo
- lead colors: yellow, red, blue
- many colors of the line depending on the angle and rotation of the pencil
- every pencil with imprinted bar code
- 12 pcs. in tube



fiorello®



## Kredki ołówkowe trójkątne

- świetna opcja dla najmłodszych dzieci w wieku przedszkolnym i wczesnoszkolnym
- trójkątny kształt umożliwia ćwiczenie prawidłowego uchwytu, jest wygodny w użytkowaniu
- supermiękki i wydajny grafit w jaskrawych i wyrazistych kolorach
- korpus kredki pokryty trwałym lakierem
- każda kredka ma miejsce na podpis

INDEKS INDEX ZESTAW SET EAN BARCODE

170-2120 24 kol. col.  8 003511 425166

## Triangular color pencils

- excellent option for kindergarten and primary school children
- triangular shape is easy to use, enables training of correct grip
- extra soft and efficient lead, vivid and expressive colors
- pencil covered with durable lacquer
- every pencil with name tag



CARIOCA®



## Kredki ołówkowe

- ostrzone
- długość 17,5 cm
- lakierowane, łatwe do ostrzenia
- supermiękki grafit
- intensywne kolory

INDEKS INDEX ZESTAW SET EAN BARCODE

170-1462 12 kol. col.  8 003511 403805

170-1464 24 kol. col.  8 003511 403812

## Color pencils

- sharpened
- 17,5 cm long
- lacquered, easy to sharpen
- supersoft lead
- vivid colors





**CARIOCA®**

## Kredki ołówkowe TITA

- nowa linia kredek ołówkowych
- wysokiej jakości kredki bezdrzewne
- bardzo miękkie i gładki grafit
- wyraziste i intensywne kolory
- grafit odporny na złamanie
- łatwe do ostrzenia

## Kredki ołówkowe TITA



## Kredki ołówkowe TITA wymazywalne

- wymazywalne za pomocą umieszczonej na końcu gumki
- miejsce na podpis na każdej kredce



## Kredki ołówkowe pastelowe

- ostrzone
- niezwykle gładkie rysowanie
- modne pastelowe kolory
- łatwe do ostrzenia
- przekrój sześciokątny



## Color pencils TITA

- new line of color pencils
- high quality woodless pencils
- very soft and smooth lead
- vivid, expressive colors
- resistant to fall
- easy to sharpen

## Color pencils TITA

INDEKS INDEX	ZESTAW SET	EAN BARCODE
170-2326	12 kol. col.	
170-2327	24 kol. col.	

## Color pencils TITA erasable

- erasable with rubber placed on the end
- place for signature on every pencil



INDEKS INDEX	ZESTAW SET	EAN BARCODE
170-2428	12 kol. col.	

**! 50 różnych kolorów**  
50 different colors

**srebrna, złota i neon**  
silver, gold & neon **!**

INDEKS INDEX	ZESTAW SET	EAN BARCODE
160-2208	50 kol. col.	

## Color pencils pastel

- sharpened
- extremely smooth drawing
- modern pastel colors
- easy to sharpen
- hexagonal cross-section

INDEKS INDEX	ZESTAW SET	EAN BARCODE
160-2229	12 kol. col.	

## Kredki ołówkowe Acquarell

- intensywne kolory
- wysokiej jakości, miękki grafit
- po rozmoczeniu rysunku za pomocą wilgotnego pędzelka można uzyskać efekt farb akwarelowych
- nie zawierają drewna z lasów deszczowych

## Kredki ołówkowe Acquarell

INDEKS INDEX	ZESTAW SET	EAN BARCODE
170-2440	12 kol. col.	

## Kredki ołówkowe Acquarell w metalowym etui

- eleganckie, bezpieczne metalowe etui

INDEKS INDEX	ZESTAW SET	EAN BARCODE
170-2472	12 kol. col.	

## Kredki ołówkowe BiColor

- kredki o wysokiej wytrzymałości, odporne na pękanie
- niezwykle gładkie rysowanie
- jasne kolory z doskonałym pokryciem
- trójkątny kształt uczy prawidłowego chwytu
- zestaw 24 dwustronne kredki to 48 różnych kolorów, zestaw 12 dwustronnych kredek to 24 różne kolory
- funkcjonalne: w piórniku więcej kolorów zajmuje mniej miejsca
- łatwe do ostrzenia



INDEKS INDEX	ZESTAW SET	EAN BARCODE
160-2214	12 szt. / 24 kol. 12 pcs. / 24 col.	
160-2215	24 szt. / 48 kol. 24 pcs. / 48 col.	

## Color pencils Acquarell

- brilliant colors
- high quality, soft lead
- blend the colors with moist brush for watercolor effect
- no rain forest wood included

## Color pencils Acquarell



## Color pencils Acquarell in metal case

- safe metal tin box



CARIOCA®



## Color pencils BiColor

- durable pencils, resistant to cracking
- extremely smooth drawing
- bright colors with perfect coverage
- triangular shape enables training of correct grip
- set 24 double-sided crayons = 48 different colors, set 12 double-sided crayons = 24 different colors
- functional: in the pencil case, more colors take up less space
- easy to sharpen

CARIOCA®





kupując, wspierasz  
program dożywiania dzieci  
[www.pajacyk.pl](http://www.pajacyk.pl)



## Kredki świecowe

- jaskrawe, wyraziste kolory
- kryjące: kolejne warstwy dokładnie pokrywają poprzednie



## Wax crayons

- vivid, expressive colors
- opaque: top layer covers thoroughly the bottom one

INDEKS INDEX	ZESTAW SET	EAN BARCODE
170-1381	6 kol. col.	5 903364 244750
170-1382	8 kol. col.	5 903364 244774
170-1383	12 kol. col.	5 903364 244798
170-1385	16 kol. col.	5 903364 244811
170-1386	24 kol. col.	5 903364 244835
170-1387	32 kol. col.	5 903364 244859

## Kredki świecowe JUMBO

- grube
- jaskrawe, wyraziste kolory
- kryjące – kolejne warstwy dokładnie pokrywają poprzednie



## Wax crayons JUMBO

- thick
- vivid, expressive colors
- opaque – top layer covers thoroughly the bottom one

INDEKS INDEX	ZESTAW SET	EAN BARCODE
170-1384	12 kol. col.	5 903364 246181



## Kredki świecowe JUMBO trójkątne

- grube
- jaskrawe, wyraziste kolory
- kryjące – kolejne warstwy dokładnie pokrywają poprzednie



## Wax crayons JUMBO triangular

- thick
- vivid, expressive colors
- opaque – top layer covers thoroughly the bottom one

INDEKS INDEX	ZESTAW SET	EAN BARCODE
170-2209	12 kol. col.	5 903364 258832

## Kredki świecowe

- wysokiej jakości kredki świecowe
- łatwe do ostrzenia
- jaskrawe, wyraziste kolory
- kryjące – kolejne warstwy dokładnie pokrywają poprzednie

INDEKS INDEX ZESTAW SET EAN BARCODE

170-1870 12 kol. col.



## Wax crayons

- high quality wax crayons
- easy to sharpen
- vivid, expressive colors
- opaque – top layer covers thoroughly the bottom one

CARIOCA®



## Kredki Plastello JUMBO

- nowoczesne kredki świecowe: trwalsze, mniej łamliwe niż tradycyjne
- nowa formuła zapewnia trzykrotnie dłuższe pisanie
- niebrudzące
- trójkątny kształt zapewnia wygodne trzymanie

INDEKS INDEX ZESTAW SET EAN BARCODE

170-2185 12 kol. col.



## Wax crayons Plastello JUMBO

- innovative wax crayons: more durable, less fragile to traditional wax crayons
- new formula enables three times longer drawing line
- clean
- triangular shape provides comfortable grip

CARIOCA®



## Pastele olejne

- wysokiej jakości, supermiękkie pastele
- intensywne kolory odporne na światło
- łatwe rozprowadzanie oraz mieszanie kolorów
- mocno kryjące
- do stosowania na papierze, tekturze, płótnie, drewnie

INDEKS INDEX ZESTAW SET EAN BARCODE

170-2441 12 kol. col.



170-2442 24 kol. col.



## Oil pastels

- high quality super soft oil pastels
- brilliant colors resistant to light
- easy drawing and blending of colors
- high coverage of the painted surface
- for paper, cardboard, canvas and wood

CARIOCA®



# CARIOCA<sup>®</sup> baby



## CARIOCA<sup>®</sup> baby



### Kredki Misiaki BABY

- stworzone z myślą o najmłodszych, przeznaczone dla dzieci od 1. roku życia
- kredki w zabawnym kształcie misia zachęcają do zabawy
- tył kredki zawiera wypustki, które są pomocne w nauce chwytania
- intensywne kolory
- bezzapachowe i niebrudzące
- 48 szt.: praktyczny kuferek ułatwiający przechowywanie kredek



### Teddy crayons BABY

- specifically developed for children over 1 year old
- teddy bear shape encourage toddlers to play
- special tabs on every crayon help to develop gripping
- brilliant colors
- clean, odorless
- 48 pcs.: useful box for easy storage of crayons



• for children from 1 year old!

CE

INDEKS	INDEX	ZESTAW SET	EAN BARCODE
160-2209		6 kol. col.	8 003511 429560
160-2217		48 szt. (8x6 kol.) 48 pcs. (8x6 col.)	8 003511 429584

• 6 różnych emocji:



• 6 various emotions:

## Kredki 3w1 BABY

- wyjątkowo grube okrągłe kredki
- przeznaczone dla małych dzieci, od 1. roku życia
- 3w1: mogą być używane jako tradycyjne kredki, kredki świecowe lub akwarele
- supermiękkie i wydajny grafit w jaskrawych, wyrazistych kolorach



• for children from 1 year old!

INDEKS INDEX ZESTAW SET EAN BARCODE

170-2348

10 kol. col.



CARIOCA  
Baby

## Kredki ołówkowe trójkątne BABY

- grube kredki trójkątne dla dzieci od 2. roku życia
- nie zawierają drewna: po złamaniu nie tworzą się ostre drzazgi
- świetna propozycja dla najmłodszych dzieci w wieku przedszkolnym i wczesnoszkolnym
- trójkątny kształt umożliwia ćwiczenie prawidłowego uchwytu, jest wygodny w użytkowaniu
- supermiękkie i wydajny grafit w jaskrawych, wyrazistych kolorach odporny na złamanie
- łatwe do ostrzenia

## Triangular color pencils BABY

- thick triangular color pencils for children from 2 years old
- wood-free: no sharp splinters when broken
- excellent option for kindergarten and primary school children
- triangular shape is easy to use, enables training of correct grip
- extra soft and efficient grip, vivid and expressive colors, resistant to cracking
- easy to sharpen

**!** dla dzieci od 2. roku życia  
for children from 2 years old

INDEKS INDEX ZESTAW SET EAN BARCODE

170-2349

10 kol. col.



CARIOCA  
Baby

## Kredki BABY

- super miękkie pastele olejne
- stworzone z myślą o najmłodszych, przeznaczone dla dzieci od 2 lat
- ekstra grube
- pomocne w nauce chwytania
- stymulują zdolności motoryczne
- jasne, żywe kolory
- zmywalne
- średnica kredki 15 mm

## BABY crayons

- super soft oil pastels
- developed for children from 2 years old
- extra large body helps to develop correct grip
- stimulate motor skills
- bright colors
- washable
- crayon diameter 15 mm

**!** dla dzieci od 2. roku życia  
for children from 2 years old

INDEKS INDEX ZESTAW SET EAN BARCODE

170-2573

8 kol. col.



CARIOCA  
Baby



## Pisaki-Misiaki BABY JUMBO

- stworzone z myślą o najmłodszych, przeznaczone dla dzieci od 1. roku życia
- zabawne zatyczki w formie główki misia zachęcają dzieci do zamykania pisaków
- zdobiony obrazkami korpus w rozmiarze Jumbo łatwy do uchwycenia dla małej rączki
- tusz łatwy do usunięcia ze skóry lub tkaniny za pomocą samej wody
- końcówka wyposażona w blokadę – nie ma możliwości wciśnięcia jej do środka
- owalna końcówka bardzo mało wystaje z obsadki – trudno ją ugryźć lub zniszczyć przez uderzenia



## Fibre pens BABY JUMBO

- specifically developed for children over 1 year old
- funny, bear-shaped plugs encourage children to close marker's cap
- large size of decorated body makes it easy for young hands to hold
- superwashable ink – easy to remove from skin or fabric with water only
- point-blocked – not possible to push it inside
- flat oval tip hard to bite or shatter



• for children from 1 year old!

INDEKS INDEX ZESTAW SET EAN BARCODE

160-1930

6 kol. col.



## Pisaki Super Baby

- stworzone z myślą o najmłodszych, przeznaczone dla dzieci od 2 lat
- duża, zaokrąglona końcówka zapewnia maksimum bezpieczeństwa użytkowania i umożliwia łatwe wypełnienie dużych powierzchni
- polietylenowa końcówka o grubości 7 mm
- końcówka wyposażona w blokadę – nie ma możliwości wciśnięcia jej do środka
- wysokiej jakości, wyrazisty tusz na bazie wody
- tusz łatwy do usunięcia ze skóry lub tkaniny za pomocą samej wody
- bezpieczna wentylowana zatyczka umożliwia oddychanie w przypadku połknięcia



## Fibre pens Super Baby

- specifically developed for children over 2 years old
- large round tip provides maximum safety and covers large areas
- fibre pen 7 mm thick
- point-blocked – not possible to push it inside
- high quality vivid ink, water-based
- superwashable ink – easy to remove from skin or fabric with water only
- safe ventilated plug enables breathing if swallowed

**! dla dzieci od 2. roku życia**  
for children from 2 years old

INDEKS INDEX ZESTAW SET EAN BARCODE

160-1970

6 kol. col.



160-1892

12 kol. col.



## Farby temperey do malowania palcami

- idealne dla najmłodszych, którzy jeszcze nie potrafią używać pędzla
- można je dowolnie mieszać, co pozwala uzyskać nowe kolory i odcienie
- łatwo zmywalne z rąk i tkanin
- bezpieczne, bezzapachowe
- gotowe do użycia bez dodawania wody

INDEKS INDEX	ZESTAW SET	EAN BARCODE
170-2275	6 kol. x 80 ml 6 col. x 80 ml	

## Finger paints

- perfect for toddlers who are not yet able to use brush
- can be mixed to obtain new colors and shades
- easy washable from hands and fabric
- safe, odorless
- ready to use with no addition of water







**! dla dzieci od 2. roku życia**  
! for children from 2 years old



INDEKS INDEX	ZESTAW SET	EAN BARCODE
170-2574	8 kol. x 50 ml 8 col. x 50 ml	



- opak. 500 ml
- bottles 500 ml

INDEKS INDEX	KOLOR COLOR	EAN BARCODE
170-2434	○ biały white	
170-2439	● żółty yellow	
170-2436	● czerwony red	
170-2437	● niebieski blue	
170-2438	● zielony green	
170-2435	● czarny black	



## Pędzel BABY

- łatwy do trzymania
- idealny do dużych powierzchni
- syntetyczne włosie

**! dla dzieci od 2. roku życia**  
! for children from 2 years old

INDEKS INDEX	EAN BARCODE
170-2592	

## BABY brush

- easy to handle
- perfect for large surfaces
- synthetic bristle





# CARIOCA<sup>®</sup> METALLIC



METALICZNE – IDEALNE DO CIEMNYCH POWIERZCHNI

METALLIC – PERFECT FOR DARK SURFACES

## CARIOCA<sup>®</sup> METALLIC



### Kredki ołówkowe metaliczne

- idealne do ciemnych powierzchni
- ostrzone
- łatwe do ostrzenia
- mocny grafit
- sześciokątne

### Metallic color pencils

- perfect for dark surfaces
- sharpened
- easy to sharpen
- strong lead
- hexagonal cross-section



INDEKS INDEX ZESTAW SET EAN BARCODE

170-2567

12 kol. col.



## CARIOCA<sup>®</sup> METALLIC



### Kredki świecowe metaliczne

- idealne do ciemnych powierzchni
- kryjące – kolejne warstwy dokładnie pokrywają poprzednie

### Metallic crayons

- perfect for dark surfaces
- high covering – top layer covers thoroughly the bottom one



INDEKS INDEX ZESTAW SET EAN BARCODE

170-2568

8 kol. col.



## Pisaki metaliczne

- idealne do ciemnych powierzchni
- trwałe kolory na porowatych powierzchniach, usuwalne z gładkich powierzchni
- można utrwalić emalią akrylową, aby uzyskać efekt na bardzo długi czas
- tusz łatwy do usunięcia ze skóry lub tkaniny za pomocą samej wody
- poliesterowa końcówka
- końcówka wyposażona w blokadę – nie ma możliwości wciśnięcia jej do środka
- bezpieczna wentylowana zatyczka umożliwia oddychanie w przypadku połknięcia
- obudowa z tworzywa sztucznego pochodzącego w 53% z recyklingu



INDEKS INDEX ZESTAW SET

170-2569 8 kol. col.

EAN BARCODE



CE 0,5-1 mm

## Metallic fibre pens

- perfect for dark surfaces
- permanent colors on porous surfaces and removable from smooth surfaces
- fix with acrylic enamel for a long-lasting effect
- easy to remove from skin or fabric with water only
- felt tip pens
- safe ventilated plug enables breathing if swallowed
- point-blocked: not possible to push it inside
- 53% recycled plastic body



CARIOCA  
METALLIC

## Farby w szyfcie Temperello metaliczne

- idealne do ciemnych powierzchni
- miękki szyft pozwala na łatwe i przyjemne malowanie
- nie wymagają używania pędzla i wody, ale można ich użyć, by uzyskać efekt akwareli
- wyraziste, łatwo mieszalne kolory
- łatwowymyalne
- mocno kryjące
- szybkoschnące
- nie marszczą papieru
- nie zawierają rozpuszczalników

INDEKS INDEX ZESTAW SET

170-2570 6 kol. col.

EAN BARCODE



## Poster paint stick Temperello metallic

- perfect for dark surfaces
- soft stick, easy and comfortable painting
- it can be used with no brush or water, but you can use it to create watercolor effect
- vivid, blendable colors
- easy to clean
- high covering
- quick-drying
- no paper wrinkling
- solvent free



CARIOCA  
METALLIC

# CARIOCA<sup>®</sup> Temperello

KOLOROWE JAK FARBY ŁATWE JAK KREDKI  
COLORFUL LIKE PAINTS EASY LIKE CRAYONS



CARIOCA<sup>®</sup>

## Farby w szyćcie Temperello

- miękki szyćt pozwala na łatwe i przyjemne malowanie
- nie wymagają używania pędzla i wody, ale można ich użyć, by uzyskać efekt akwareli
- wyraziste, łatwo mieszalne kolory
- łatwo zmywalne
- mocno kryjące, szybko schnące
- nie marszczą papieru
- nie zawierają rozpuszczalników
- opakowanie zawiera: 12 kolorów klasycznych, 6 neonowych, 6 metalicznych

## Poster paint stick Temperello

- soft stick, easy and comfortable painting
- it can be used with no brush or water, but you can use it to create watercolor effect
- vivid, blendable colors
- easy to clean
- high covering, quick drying, no paper wrinkling
- solvent free
- set includes: 12 classic, 6 neon, 6 metallic colors



efekt kredki świecowej  
wax crayon



efekt tempery  
tempera paint



efekt farb wodnych  
watercolor



mieszanie kolorów  
blending

CE

INDEKS INDEX

170-2524

ZESTAW SET

24 kol. col.

EAN BARCODE



## Kredki do twarzy MaskUp

- wykręcane kredki do twarzy i ciała
- łatwo się rozprowadzają – nie brudzą rąk
- łatwo zmywalne ze skóry za pomocą wody z mydłem, spieralne z tkanin
- kolory łatwo mieszają się ze sobą
- możliwość zaostrenia temperówką lub nożykiem dla uzyskania precyzyjnych linii (wymagana pomoc osoby dorosłej)
- produkt testowany dermatologicznie
- kosmetyk – potwierdzona jakość
- idealne na (nie tylko) dziecięcą imprezę
- zestaw 6 intensywnych kolorów
- wewnątrz instrukcje!



INDEKS INDEX ZESTAW SET EAN BARCODE

170-2508

6 kol. col.



## Face paint MaskUp

- twisted crayons for face and body
- easy to use – no dirty hands
- washable from skin or fabric with soapy water
- colors mix easily
- use sharpener or knife to obtain precise lines (adult assistance required)
- dermatologically tested
- cosmetic – quality confirmed
- perfect for (not only) children's party
- set of 6 intense colors
- instruction inside!



CARIOCA®

BĄDŹ TYM, KIM CHCESZ...

...UŻYWAJ BEZPIECZNYCH PRODUKTÓW!



Kredki i farby do twarzy to produkty szczególne – używane są przez dzieci, a na skórze pozostają często bardzo długo. Szczególnie **ważny** jest wybór **bezpiecznego** produktu, który nie wywoła podrażnień.

BE, WHOEVER  
YOU WANT TO BE...  
...USE SAFE PRODUCTS!

Face paint is a special product: it is used by children and it remains on skin for a long time. That is why the choice of a really **safe** product is **crucial**: it cannot cause any skin irritation.



Kredki do twarzy CARIOCA MaskUp spełniają wymogi Dyrektywy w sprawie **bezpieczeństwa zabawek** 2009/48/EC oraz Regulacji dot. **produktów kosmetycznych** 2009/1223/EC.

CARIOCA MaskUp face paint conforms to Directive 2009/48/EC "**Safety of Toys**" and Regulation 2009/1223/EC "**Cosmetic products**".



## Kredki wykręcane Color Twist

- łatwe w użyciu wykręcane kredki
- nie wymagają temperowania
- niebrudzące, bezzapachowe
- miękki grafit, jaskrawe kolory
- do stosowania na papierze, tekturze i kartonie
- transparentna obudowa z widocznym kolorowym grafitem

## Twist-up crayons Color Twist

- easy to use twist-up crayons
- no need of sharpening
- clean, odorless
- soft lead, vivid colors
- for paper and cardboard
- transparent cover with color lead visible



INDEKS INDEX	ZESTAW SET	EAN BARCODE
* 170-2211	6 kol. col.	5 903364 258856
* 170-2210	12 kol. col.	5 903364 258870

\* do wyczerpania zapasów while stock lasts



## Kredki wykręcane Silky Twisters CST12

- wysokiej jakości niebrudzące, bezzapachowe kredki
- bardzo miękki wykręcany grafit
- można używać jako kredki, pastele olejne, farby wodne (po spryskaniu rysunku wodą należy użyć pędzelka)
- do stosowania na papierze lub płótnie

## Twist-up crayons Silky Twisters CST12

- high quality odorless crayons
- exceptionally soft twisted lead
- use as crayon, oil pastel or water color (spray drawing with water and use brush)
- for paper and canvas



INDEKS INDEX	ZESTAW SET	EAN BARCODE
170-2225	12 kol. col.	8 02946 507597



## Kredki artystyczne COLORIX CRX5PC12

- oryginalne kredki artystyczne
- wykręcane – nie brudzą rąk
- mogą być używane jako tradycyjne kredki, pastele lub akwarele (przy użyciu wilgotnego pędzelka)
- do stosowania na papierze lub płótnie
- bezzapachowe, łatwo zmywalne
- jaskrawe, wyraziste kolory
- kryjące – kolejne warstwy dokładnie pokrywają poprzednie
- supermiękki grafit

## Artistic crayons COLORIX CRX5PC12



- original artistic crayons
- twist-up: no dirty hands
- can be used as traditional crayons, pastels or water colors (with wet brush)
- for paper or canvas
- odorless, easily washable
- bright, vivid colors
- opaque – top layer covers thoroughly the bottom one
- extra soft lead



INDEKS INDEX	ZESTAW SET	EAN BARCODE
170-2105	12 kol. col.	8 02946 502127

## Pisaki

- końcówka o grubości 2 mm, z włókien polietylenowych
- tusz na bazie wody
- bezpieczna wentylowana zatyczka umożliwia oddychanie w przypadku połknięcia

INDEKS INDEX	ZESTAW SET	EAN BARCODE
160-1387	6 kol. col.	
160-1382	12 kol. col.	



## Fibre pens

- PE fibre tip 2 mm thick
- water-based ink
- safe ventilated plug enables breathing if swallowed



## Pisaki GR-725

- nylonowa końcówka o grubości 2 mm
- tusz na bazie wody
- bezpieczna wentylowana zatyczka umożliwia oddychanie w przypadku połknięcia
- pakowane po 25 szt. w woreczku

INDEKS INDEX	KOLOR COLOR	EAN BARCODE
* 160-1983	niebieski blue	
* 160-1984	zielony green	

\* do wyczerpania zapasów while stock lasts

## Fibre pens GR-725

- fibre tip 2 mm thick
- water-based ink
- safe ventilated plug enables breathing if swallowed
- 25 pcs. in foil bag

Grand®



## Pisaki trójkątne GR-290

- pisaki o przekroju trójkątnym – wygodne do trzymania
- tusz na bazie wody
- zestaw 12 kolorów w rozkładanym plastikowym pudełku
- bezpieczna wentylowana zatyczka umożliwia oddychanie w przypadku połknięcia



INDEKS INDEX	ZESTAW SET	EAN BARCODE
160-1980	12 kol. col.	

## Triangular fibre pens GR-290

- triangular cross-section provide comfortable grip
- water-based ink
- set of 12 colors in folded plastic case
- safe ventilated plug enables breathing if swallowed

fiorelo®





### Pisaki Fun GR-F887-12

- pisaki szkolne w intensywnych kolorach
- końcówka wyposażona w blokadę – nie ma możliwości wciśnięcia jej do środka
- wyrazisty tusz na bazie wody
- bezpieczna wentylowana zatyczka umożliwia oddychanie w przypadku połknięcia
- spieralne

### Fibre pens Fun GR-F887-12

- school fibre pens in intense colors
- point-blocked – not possible to push it inside
- vivid ink, water-based
- safe ventilated plug enables breathing if swallowed
- washable from fabrics



INDEKS INDEX ZESTAW SET EAN BARCODE

160-2115

12 kol. col.



### Pisaki Bimarker GR-F816-12

- dwie końcówki: cienka i szeroka
- końcówka wyposażona w blokadę – nie ma możliwości wciśnięcia jej do środka
- bezpieczna wentylowana zatyczka umożliwia oddychanie w przypadku połknięcia
- spieralne

### Bimarker markers GR-F816-12

- double-sided markers with wide and narrow tip
- point-blocked – not possible to push it inside
- safe ventilated plug enables breathing if swallowed
- washable from fabrics



INDEKS INDEX ZESTAW SET EAN BARCODE

160-2037

12 kol. col.



### Pisaki Comfort GR-F865-12

- wygodny trójkątny uchwyt z elementami antypoślizgowymi
- duża okrągła końcówka
  - końcówka wyposażona w blokadę – nie ma możliwości wciśnięcia jej do środka
- bezpieczna wentylowana zatyczka umożliwia oddychanie w przypadku połknięcia
- spieralne

### Comfort markers GR-F865-12

- comfortable triangular grip with non-slip elements
- large round tip
- point-blocked – not possible to push it inside
- safe ventilated plug enables breathing if swallowed
- washable from fabrics



INDEKS INDEX ZESTAW SET EAN BARCODE

\* 160-2032

12 kol. col.



\* do wyczerpania zapasów while stock lasts



## Pisaki Jumbo trójkątne GR-F659-12

- trójkątna obudowa ułatwia trzymanie
- gruba końcówka wyposażona w blokadę  
– nie ma możliwości wciśnięcia jej do środka
- bezpieczna wentylowana zatyczka umożliwia oddychanie w przypadku połknięcia
- spiralne

## Jumbo triangular markers GR-F659-12

- triangular shape for comfortable grip
- large tip
- point-blocked – not possible to push it inside
- safe ventilated plug enables breathing if swallowed
- washable from fabrics

INDEKS INDEX ZESTAW SET

160-2030 12 kol. col.

EAN BARCODE



kupując, wspierasz  
program dożywiania dzieci  
[www.pajacyk.pl](http://www.pajacyk.pl)



## Pisaki Super Baby GR-F165-8

- przeznaczone dla małych dzieci
- krótka, zaokrąglona końcówka umożliwia łatwe kolorowanie dużych powierzchni
- końcówka wyposażona w blokadę  
– nie ma możliwości wciśnięcia jej do środka
- bezpieczna wentylowana zatyczka umożliwia oddychanie w przypadku połknięcia
- spiralne

## Super Baby markers GR-F165-8

- for young children
- short rounded tip for easy coloring of large surfaces
- point-blocked – not possible to push it inside
- safe ventilated plug enables breathing if swallowed
- washable from fabrics

INDEKS INDEX ZESTAW SET

160-2033 8 kol. col.

EAN BARCODE







## Pisaki Mega GR-F815-8

- wyjątkowa stożkowa końcówka umożliwia rysowanie linii o grubości 1-8 mm
- końcówka wyposażona w blokadę – nie ma możliwości wciśnięcia jej do środka
- spieralne

## Mega markers GR-F815-8

- unique conical tip enables line thickness 1-8 mm
- point-blocked – not possible to push it inside
- washable from fabrics



CE 1-8 mm

INDEKS INDEX

ZESTAW SET

EAN BARCODE

\* 160-2031

8 kol. col.



\* do wyczerpania zapasów while stock lasts



## Pisaki Glitter GR-F118-6

- jasne, żywe, nieblaknące kolory tuszu brokatowego
- tusz wodoodporny, nie zawiera metali ciężkich
- brokat nie wykrusza się
- końcówka okrągła
- bezpieczna wentylowana zatyczka umożliwia oddychanie w przypadku połknięcia

## Glitter markers GR-F118-6

- bright, vivid, no fading colors of glitter ink
- waterproof ink, no heavy metals
- strong adhesion of the glitter
- round tip
- safe ventilated plug enables breathing if swallowed



CE 1,5 mm

INDEKS INDEX

ZESTAW SET

EAN BARCODE

\* 160-1998

6 kol. col.



\* do wyczerpania zapasów while stock lasts



## Pisaki Metallic GR-F129-6

- zmywalny tusz metaliczny
- przeznaczony do szkła, ceramiki, plastiku, drewna, płyt CD itp.
- końcówka wyposażona w blokadę – nie ma możliwości wciśnięcia jej do środka
- końcówka okrągła

## Metallic markers GR-F129-6

- washable metallic ink
- for glass, ceramic, plastic, wood, CD etc.
- point-blocked – not possible to push it inside
- round tip



CE 1-3 mm

INDEKS INDEX

ZESTAW SET

EAN BARCODE

160-1999

6 kol. col.



## Pisaki Flash wymazywalne GR-F890-12

- w zestawie 11 pisaków kolorowych oraz wymazywacz
- wymazywacz służy do poprawiania błędów lub pisania białym kolorem na pokolorowanej powierzchni
- końcówka wyposażona w blokadę – nie ma możliwości wciśnięcia jej do środka
- bezpieczna wentylowana zatyczka umożliwia oddychanie w przypadku połknięcia
- spiralne



INDEKS INDEX ZESTAW SET  
160-2151 12 szt. pcs.

EAN BARCODE



CE 1-3 mm

## Flash markers erasable GR-F890-12

- set of 11 color markers and eraser
- eraser for correcting mistakes or writing with white on colored surface
- point-blocked – not possible to push it inside
- safe ventilated plug enables breathing if swallowed
- washable from fabrics



kupując, wspierasz program dożywiania dzieci  
[www.pajacyk.pl](http://www.pajacyk.pl)



## Pisaki MultiColor GR-F166-8

- w zestawie 6 pisaków kolorowych oraz 2 pisaki Magic zmieniające kolor
- magiczny pisak pozwala na uzyskanie dwóch kolorów każdego pisaka
- końcówka wyposażona w blokadę – nie ma możliwości wciśnięcia jej do środka
- bezpieczna wentylowana zatyczka umożliwia oddychanie w przypadku połknięcia



INDEKS INDEX ZESTAW SET  
160-2035 8 szt. pcs.

EAN BARCODE



CE 1,4-6 mm

## MultiColor markers GR-F166-8

- set of 6 color markers and 2 Magic markers for changing colors
- Magic marker enables to obtain 2 different colors of every color marker
- point-blocked – not possible to push it inside
- safe ventilated plug enables breathing if swallowed





## Pisaki T-Shirt GR-F125-6

- pisaki do ozdabiania tkanin
- utrwalenie rysunku następuje przez zaprasowanie
- utrwalone wzory są odporne na pranie w temp. do 60°C
- końcówka wyposażona w blokadę – nie ma możliwości wciśnięcia jej do środka
- bezpieczna wentylowana zatyczka umożliwia oddychanie w przypadku połknięcia

## T-Shirt liners GR-F125-6

- for decorating of fabric
- fix the drawing by ironing
- fixed drawings are resistant to washing in water up to 60°C
- point-blocked – not possible to push it inside
- safe ventilated plug enables breathing if swallowed



INDEKS INDEX

ZESTAW SET

EAN BARCODE

160-2038

6 kol. col.



kupując, wspierasz program dożywiania dzieci  
[www.pajacyk.pl](http://www.pajacyk.pl)



## Pisaki stemple GR-F205ST

- pisaki dwa w jednym: końcówka pisząca i nasączona pieczętka z wesołym wzorem
- tusz na bazie wody
- bezpieczna wentylowana zatyczka umożliwia oddychanie w przypadku połknięcia

## Stamp pens GR-F205ST

- 2-in-1: writing tip and soaked stamp with cheerful pattern
- water-based ink
- safe ventilated plug enables breathing if swallowed



INDEKS INDEX

ZESTAW SET

EAN BARCODE

160-2114

12 kol. col.



## Pisaki Sketch dwustronne GR-F726-12

- podwójna końcówka: pędzelek + cienkopis
- do tworzenia boulet journali, komiksów i innych prac kreatywnych
- końcówka pędzelkowa pozwala uzyskać ciągłe, jednolite linie o różnej grubości
- cienka końcówka przeznaczona do cienkich linii i detali
- bezpieczna wentylowana zatyczka umożliwia oddychanie w przypadku połknięcia
- grubość linii: cienka końcówka 0,4 mm, pędzelek 0–6 mm

CE 0,4 mm 0-6 mm

INDEKS INDEX ZESTAW SET EAN BARCODE

160-2232

12 kol. col.



## Sketch markers double-sided GR-F726-12

- double nib: brush & fineliner
- for bullet journals, cartoons and other creative works
- brush nib enables smooth lines with various thickness
- fineliner for details
- safe ventilated plug enables breathing if swallowed
- line thickness: fineliner 0,4 mm, brush nib 0–6 mm

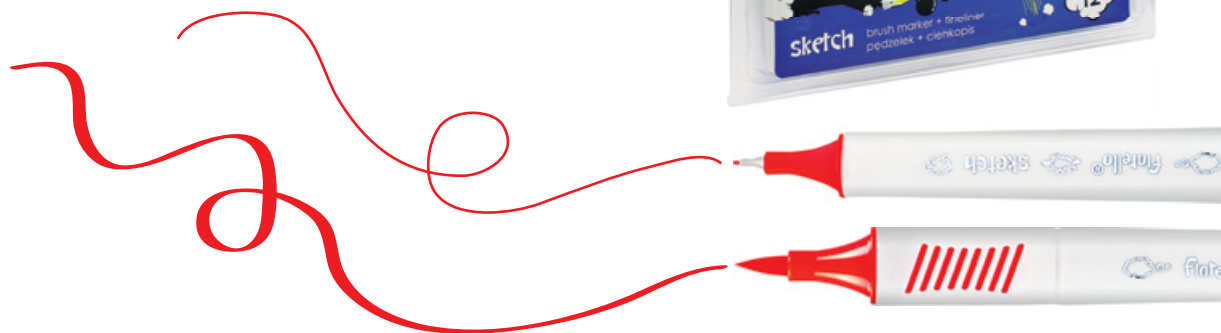

## Marker permanentny POSTER GR-1712

- do pisania i rysowania
- idealny do plakatów
- szybkoschnący, wodoodporny
- może być stosowany na gładkiej powierzchni
- podwójna końcówka 10 mm/17 mm
- opak. 6 szt.

## Permanent POSTER Marker GR-1712

- for writing and drawing
- perfect for posters
- quick dry, waterproof
- can be used on any smooth surface
- double nib 10 mm/17 mm
- box 6 pcs.



INDEKS INDEX KOLOR COLOR EAN BARCODE

160-2240

● czarny black



160-2242

● czerwony red



160-2241

● niebieski blue



160-2243

● zielony green



160-2245

● różowy pink



160-2244

● żółty yellow



10 mm 17 mm





## Markery akrylowe GR-1106

- szybko schnący tusz na bazie wody
- kryjące, intensywne kolory
- przeznaczone do wielu powierzchni, jak karton, drewno, ceramika, tynk, tkanina, skóra...
- można ozdabiać nimi torebki, buty, pokrowce na telefon, kamienie i inne
- dla artystów i amatorów

## Acrylic markers GR-1106

- water-based, quick-drying
- bright, opaque colors
- for many surfaces, eg. for cardboard, wood, ceramic, plaster, fabric, leather...
- to decorate handbags, shoes, mobile phone shells, stones and other materials
- for artists and amateurs



CE 2 mm

INDEKS INDEX ZESTAW SET

160-2262 12 kol. col.

EAN BARCODE



## Pisaki JOY

- miękka filcowa końcówka
- końcówka wyposażona w blokadę – nie ma możliwości wciśnięcia jej do środka
- wysokiej jakości, wyrazisty tusz na bazie wody
- tusz łatwy do usunięcia ze skóry lub tkaniny za pomocą samej wody
- bezpieczna wentylowana zatyczka umożliwia oddychanie w przypadku połknięcia

## Felt tip pens JOY

- soft felt tip
- point-blocked: not possible to push it inside
- high quality vivid ink, water-based
- superwashable ink – easy to remove from skin or fabrics with water only
- safe ventilated plug enables breathing if swallowed



CE 1-2 mm

INDEKS INDEX ZESTAW SET

160-1466 6 kol. col.

160-1467 10 kol. col.

160-1468 12 kol. col.

160-1469 18 kol. col.

160-1470 24 kol. col.

160-1472 36 kol. col.

EAN BARCODE



## Pisaki JOY

- pakowane po 50 szt.

## Felt tip pens JOY

- packaging: 50 pcs.

INDEKS INDEX KOLOR COLOR

160-1475 ● czarny black

160-1476 ● czerwony red

EAN BARCODE



## Pisaki BIRELLO

- dwie filcowe końcówki o grubości pisania 2 i 4 mm
- końcówka wyposażona w blokadę – nie ma możliwości wciśnięcia jej do środka
- wysokiej jakości, wyrazisty tusz na bazie wody
- tusz łatwy do usunięcia ze skóry lub tkaniny za pomocą samej wody
- bezpieczna wentylowana zatyczka umożliwia oddychanie w przypadku połknięcia

INDEKS	INDEX	ZESTAW SET	EAN BARCODE
160-1462	10 kol. col.		
160-1463	12 kol. col.		
160-1464	24 kol. col.		

## Felt tip pens BIRELLO

- dual tip, 2 and 4 mm line thickness
- point-blocked – not possible to push it inside
- high quality vivid ink, water-based
- superwashable ink – easy to remove from skin or fabric with water only
- safe ventilated plug enables breathing if swallowed



CARIOCA®



## Pisaki Bi-Color

- dwustronne: 12 pisaków, 24 kolory
- końcówka filcowa
- intensywne kolory
- tusz łatwy do usunięcia ze skóry lub tkaniny za pomocą samej wody
- końcówka wyposażona w blokadę – nie ma możliwości wciśnięcia jej do środka
- bezpieczna wentylowana zatyczka umożliwia oddychanie w przypadku połknięcia

INDEKS	INDEX	ZESTAW SET	EAN BARCODE
160-2164	12 szt./24 kol. 12 pcs./24 col.		

## Bi-Color markers

- double-sided – 12 markers, 24 colors
- felt tip
- brilliant colors
- superwashable ink – easy to remove from skin or fabric with water only
- point-blocked – not possible to push it inside
- safe ventilated plug enables breathing if swallowed



CARIOCA®



## Pisaki JUMBO

- filcowa końcówka
- końcówka wyposażona w blokadę – nie ma możliwości wciśnięcia jej do środka
- wysokiej jakości, wyrazisty tusz na bazie wody
- tusz łatwy do usunięcia ze skóry lub tkaniny za pomocą samej wody
- bezpieczna wentylowana zatyczka umożliwia oddychanie w przypadku połknięcia

INDEKS	INDEX	ZESTAW SET	EAN BARCODE
160-1479	12 kol. col.		

## Felt tip pens JUMBO

- felt tip
- point-blocked – not possible to push it inside
- high quality vivid ink, water-based
- superwashable ink – easy to remove from skin or fabric with water only
- safe ventilated plug enables breathing if swallowed

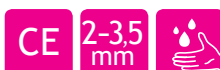

CARIOCA®



**CARIOCA®**



**Pisaki metrowe**

- jeden metr pisaków
- filcowa końcówka
- końcówka wyposażona w blokadę – nie ma możliwości wciśnięcia jej do środka
- wysokiej jakości, wyrazisty tusz na bazie wody
- tusz łatwy do usunięcia ze skóry lub tkaniny za pomocą samej wody
- bezpieczna wentylowana zatyczka umożliwia oddychanie w przypadku połknięcia
- zawiera kartonowy pojemnik na długopisy do pokolorowania (należy wyciąć z tyłu opakowania)

**Coloring meter felt tip pens**

- a meter of felt tip pens
- point-blocked: not possible to push it inside
- high quality vivid ink, water-based
- superwashable ink – easy to remove from skin or fabric with water only
- safe ventilated plug enables breathing if swallowed
- contains a pen holder to cut and color in the back part of the box



INDEKS INDEX ZESTAW SET EAN BARCODE

★ 160-2207	96 szt. pcs.	8 1003511 410223
160-2278	100 szt. pcs.	8 1003511 410193

★ do wyczerpania zapasów while stock lasts

**CARIOCA®**



**Pisaki PASTEL**

- filcowa końcówka
- końcówka wyposażona w blokadę – nie ma możliwości wciśnięcia jej do środka
- wysokiej jakości, wyrazisty tusz na bazie wody
- tusz łatwy do usunięcia ze skóry lub tkaniny za pomocą samej wody
- bezpieczna wentylowana zatyczka umożliwia oddychanie w przypadku połknięcia

**Felt tip pens PASTEL**

- felt tip pens
- point-blocked: not possible to push it inside
- high quality vivid ink, water-based
- easy to remove from skin or fabric with water only
- safe ventilated plug enables breathing if swallowed



INDEKS INDEX ZESTAW SET EAN BARCODE

160-2228	8 kol. col.	8 1003511 430320
----------	-------------	------------------



PASTELOWE – POZNAJ CAŁĄ SERIĘ  
 PASTEL – GET TO KNOW THE WHOLE SERIES



## Pisaki Magic ColorUp

- filcowa końcówka
- 4 pisaki kryjące
- 2 pisaki fluorescencyjne, zmieniające kolor pozostałych
- bezpieczna wentylowana zatyczka umożliwia oddychanie w przypadku połknięcia
- końcówka wyposażona w blokadę – nie ma możliwości wciśnięcia jej do środka



INDEKS	INDEX	ZESTAW SET	EAN BARCODE
160-2216		6 szt. pcs.	

## Magic ColorUp felt tip pens

- felt tip pens
- 4 cover pens
- 2 fluorescent pens which change the color of the others
- safe ventilated plug enables breathing if swallowed
- point-blocked: not possible to push it inside



## Pisaki Magic Laser

- filcowa końcówka
- końcówka wyposażona w blokadę – nie ma możliwości wciśnięcia jej do środka
- wysokiej jakości, wyrazisty tusz na bazie wody
- bezpieczna wentylowana zatyczka umożliwia oddychanie w przypadku połknięcia
- w zestawie pisaki kolorowe oraz wymazywacz
- wymazywacz służy do poprawiania błędów lub pisania białym kolorem na pokolorowanej powierzchni



INDEKS	INDEX	ZESTAW SET	EAN BARCODE
* 160-2223		8 szt. pcs.	
160-2277		10 szt. pcs.	

## Magic Laser felt tip pens

- felt tip pens
- point-blocked – not possible to push it inside
- high quality vivid ink, water-based
- safe ventilated plug enables breathing if swallowed
- set of color pens with eraser
- eraser for correcting errors or writing with white color on colored area



\* do wyczerpania zapasów while stock lasts

## Pisaki Magic – zestaw

- filcowa końcówka
- 9 pisaków Erasable + 1 pisak wymazujący
- 5 pisaków ColorUp + 5 pisaków fluorescencyjnych, zmieniających kolor pozostałych
- 9 pisaków ColorChange + 1 pisak zmieniający kolor
- bezpieczna wentylowana zatyczka umożliwia oddychanie w przypadku połknięcia
- końcówka wyposażona w blokadę – nie ma możliwości wciśnięcia jej do środka



INDEKS	INDEX	ZESTAW SET	EAN BARCODE
160-2271		30 szt. pcs.	

## Magic felt tip pens set

- felt tip pens
- 9 erasable pens + 1 Magic erasing pen
- 5 ColorUp pens + 5 fluorescent pens which change the color of the others
- 9 ColorChange pens + 1 Magic changing pen
- safe ventilated plug enables breathing if swallowed
- point-blocked: not possible to push it inside



CARIOCA®

CARIOCA®

CARIOCA®



**CARIOCA®**

### Pisaki Brush Tip

- filcowa końcówka w formie pędzelka
- idealne do kaligrafii
- intensywne kolory
- tusz łatwy do usunięcia ze skóry lub tkaniny za pomocą samej wody
- końcówka wyposażona w blokadę – nie ma możliwości wciśnięcia jej do środka
- bezpieczna wentylowana zatyczka umożliwia oddychanie w przypadku połknięcia



INDEKS INDEX

ZESTAW SET

EAN BARCODE

160-2165

10 kol. col.

**CARIOCA®**

### Pisaki Acquarell

- końcówka filcowa umożliwia osiągnięcie linii o grubości 2-3 mm
- końcówka wyposażona w blokadę – nie ma możliwości wciśnięcia jej do środka
- wysokiej jakości, wyrazisty tusz na bazie wody
- tusz łatwy do usunięcia ze skóry lub tkaniny za pomocą samej wody, z bawełny w temp. 60°C
- bezpieczna wentylowana zatyczka umożliwia oddychanie w przypadku połknięcia
- po rozmyciu rysunku za pomocą zmoczonego pędzelka można uzyskać efekt farb akwarelowych



INDEKS INDEX

ZESTAW SET

EAN BARCODE

160-1461

12 kol. col.

**CARIOCA®**

### Pisaki Stemple

- wysokiej jakości dwustronne pisaki: z jednej strony filcowa końcówka pisząca, a z drugiej – nasączona pieczętka z wesołym wzorem
- pieczętki: Ø 9 mm, grubość pisania 1-6 mm
- końcówka wyposażona w blokadę – nie ma możliwości wciśnięcia jej do środka
- wysokiej jakości, wyrazisty tusz na bazie wody
- bezpieczna wentylowana zatyczka umożliwia oddychanie w przypadku połknięcia



INDEKS INDEX

ZESTAW SET

EAN BARCODE

160-1902

6 kol. col.



160-1903

12 kol. col.



### Felt tip pens Brush Tip

- brush-shaped felt tip
- perfect for calligraphy stroke
- vivid colors
- superwashable ink – easy to remove from skin or fabric with water only
- point-blocked – not possible to push it inside
- safe ventilated plug enables breathing if swallowed

### Acquarell felt tip pens

- felt tip, writing width 2-3 mm
- point-blocked – not possible to push it inside
- high quality vivid ink, water-based
- superwashable ink – easy to remove from skin or fabric with water only, from cotton at 60°C
- safe ventilated plug enables breathing in case of swallow
- water color paint effect obtained with moistened brush

### Stamp markers

- high quality dual markers: classic felt tip and stamp
- stamps: Ø 9 mm, writing width 1-6 mm
- point-blocked – not possible to push it inside
- high quality vivid ink, water-based
- safe ventilated plug enables breathing if swallowed

## Pisaki zapachowe Perfume

- wysokiej jakości pisaki zapachowe
- końcówka filcowa
- pachnący, łatwo zmywalny tusz
- końcówka wyposażona w blokadę
  - nie ma możliwości wciśnięcia jej do środka
- bezpieczna wentylowana zatyczka umożliwia oddychanie w przypadku połknięcia
- aromaty nie zawierają substancji uczulających
- 12 zapachów: lukrecja, czekolada, brzoskwinia, truskawka, pomarańcza, banan, jabłko, mięta, anyż, winogrona, lawenda, wanilia

INDEKS INDEX ZESTAW SET EAN BARCODE

160-2110

12 kol. col.



## Felt tip pens Perfume

- high quality perfumed felt tip pens
- scented, washable ink
- point-blocked - not possible to push it inside
- safe ventilated plug enables breathing if swallowed
- aromas without allergenic substances
- 12 scents: liquorice, chocolate, peach, strawberry, orange, banana, apple, mint, anise, grapes, lavender, vanilla

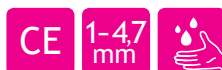

CARIOCA®



## Pisaki zapachowe Perfume MAXI

- wysokiej jakości pisaki zapachowe
- pachnący, łatwo zmywalny tusz
- końcówka wyposażona w blokadę
  - nie ma możliwości wciśnięcia jej do środka
- bezpieczna wentylowana zatyczka umożliwia oddychanie w przypadku połknięcia
- aromaty nie zawierają substancji uczulających
- 10 zapachów: lukrecja, pomarańcza, jabłko, anyż, lawenda, czekolada, truskawka, banan, winogrono, wanilia

INDEKS INDEX ZESTAW SET EAN BARCODE

160-2203

10 kol. col.



## Felt tip pens Perfume MAXI

- high quality perfumed felt tip pens
- washable ink
- point-blocked - not possible to push it inside
- safe ventilated plug enables breathing if swallowed
- aromas with no allergenic substances
- 10 scents: liquorice, orange, apple, anise, lavender, chocolate, strawberry, banana, grapes, vanilla



CARIOCA®



## Pisaki zapachowe Perfume Stemple

- wysokiej jakości pisaki zapachowe
- pachnący, łatwo zmywalny tusz
- końcówka wyposażona w blokadę
  - nie ma możliwości wciśnięcia jej do środka
- bezpieczna wentylowana zatyczka umożliwia oddychanie w przypadku połknięcia
- aromaty nie zawierają substancji uczulających
- 8 zapachów: lukrecja, pomarańcza, brzoskwinia, jabłko, truskawka, anyż, banan, lawenda

INDEKS INDEX ZESTAW SET EAN BARCODE

160-2202

8 kol. col.



## Felt tip pens Perfume STAMP

- high quality perfumed felt tip pens
- washable ink
- point-blocked - not possible to push it inside
- safe ventilated plug enables breathing if swallowed
- aromas with no allergenic substances
- 8 scents: liquorice, orange, peach, apple, strawberry, anise, banana, lavender



CARIOCA®



**CARIOCA®**



**Pisaki do tkanin  
CROMATEX**

- filcowa końcówka
- końcówka wyposażona w blokadę – nie ma możliwości wciśnięcia jej do środka
- wysokiej jakości, wyrazisty tusz na bazie wody
- trwałe, jaskrawe kolory
- bezpieczna wentylowana zatyczka umożliwia oddychanie w przypadku połknięcia
- prasowanie utrwala naniesiony na tkaninę wzór
- odporny na pranie w temp. do 60°C

**Fabric markers  
CROMATEX**

- felt tip
- point-blocked – not possible to push it inside
- high quality vivid ink, water-based
- durable vivid colors
- safe ventilated plug enables breathing if swallowed
- resistant to washing at 60°C



INDEKS INDEX	ZESTAW SET	EAN BARCODE
160-1473	6 kol. col.	8 003511 409562
160-1474	12 kol. col.	8 003511 409579

**CARIOCA®**



**Farby do tkanin**

- wysokiej jakości farby do tkanin
- pozwalają tworzyć wypukłe wzory
- intensywne żywe kolory
- czas schnięcia: min. 5 godzin, w zależności od grubości warstwy
- niespieralne – zapewniają trwałe zdobienie tkaniny

**Fabric paints**

- high quality fabric paints
- raised painting effect
- intensive bright colors
- time of drying up: min. 5 hours, depending on the amount of paint applied
- permanent decoration of fabric (not washable)



INDEKS INDEX	KOLORY COLORS	EAN BARCODE
160-2112	perłowe pearl	8 003511 421397
160-2111	neonowe neon	8 003511 421311

**AMOS®**



**Kredki do szkła  
GLASS FUN GF6P**

- kredki do różnych zastosowań
- idealne do szklanych powierzchni, takich jak szyby, lustra, kafelki itd.
- nieblaknące, trwałe, wyraziste kolory
- niebrudzące i bezzapachowe
- rozpuszczalne w wodzie
- łatwo zmywalne za pomocą wilgotnego ręcznika
- wykęcany sżyft w plastikowej obudowie

**Crayons for glass  
'Glass Fun' GF6P**

- multi purpose crayons
- perfect for glass surfaces, like window, glass, mirror, tile etc.
- consistent, durable, vivid colors
- odorless, no dirty hands
- water-soluble
- easily washable with damp towel
- twist-up lead in plastic casing



INDEKS INDEX	ZESTAW SET	EAN BARCODE
* 170-2296	6 kol. col.	8 802946 508303

\* do wyczerpania zapasów while stock lasts

## Stempelki

- do ozdabiania zeszytów, prezentów, zaproszeń, listów, prac plastycznych
- nasączone kolorowym tuszem
- obudowa w kolorze tuszu, zatyczki z wzorami
- wzory w 6 kolorach
- indywidualny kod kreskowy na każdym stempelku

## Stamps

- useful for decorating notebooks, gifts, invitations, letters, artworks
- soaked with ink
- casing in color of ink, cap showing pattern inside
- individual barcode on every stamp



## stempelki Zwierzaki ZOO

- odcisnięte kontury można pokolorować kredkami

## stamps Animals

- patterns can be colored with color pencils



INDEKS INDEX SYMBOL SYMBOL ZESTAW SET

170-2350 GR-FP-26 26 wzorów patterns

EAN BARCODE



## stempelki Literki

- pomocne w nauce czytania i pisania
- zawierają wszystkie znaki alfabetu polskiego

## stamps Letters

- help to learn reading & writing
- Polish alphabet signs included



INDEKS INDEX SYMBOL SYMBOL ZESTAW SET

170-2432 GR-FL-32 32 wzory patterns

EAN BARCODE



## stempelki Cyferki

- pomocne w nauce liczenia

## stamps Numbers

- help to learn counting



INDEKS INDEX SYMBOL SYMBOL ZESTAW SET

170-2433 GR-FC-10 10 wzorów patterns

EAN BARCODE



## stempelki Buźki

- zestaw 26 różnych wzorów lub po 10 najbardziej charakterystycznych miniek

## stamps Faces

- set of 26 various faces or 10 pcs. of the most typical ones

INDEKS INDEX SYMBOL SYMBOL MOTYW MOTIF

170-2431 GR-FF-26 buźki faces

ZESTAW SET

26 wzorów patterns

EAN BARCODE



170-2493 GR-FF-10U buźki wesole happy

10 szt. pcs.



★ 170-2494 GR-FF-10S buźki smutne sad

10 szt. pcs.



★ 170-2495 GR-FF-10N buźki neutralne neutral

10 szt. pcs.



★ do wyczerpania zapasów while stock lasts

## Farby tempery

- wodorozcieńczalne tempery
- idealne do nauki i do prac grupowych
- do malowania na wszystkich porowatych powierzchniach: papierze, kartonie, drewnie, polistyrenie itp.
- łatwo zmywalne, bezzapachowe
- można je dowolnie mieszać, co pozwala uzyskać nowe kolory i odcienie
- możliwość warstwowego malowania i korekt
- gotowe do użycia bez dodawania wody
- przechowywać w temperaturze 10–40°C



## Tempera paints

- water-soluble tempera paints
- perfect for beginners and collective works
- for rigid surfaces: paper, cardboard, wood, polystyrene
- easily washable, odorless
- can be mixed to obtain new colors and shades
- possibility of stratified painting and corrections
- ready to use with no addition of water
- store in 10–40°C



biały  
white

170-2353

500 ml



170-1440

1000 ml



łosiowy  
salmon pink

170-2278



170-1449



żółty cytrynowy  
lemon yellow

170-2367



170-1864



żółty  
yellow

170-2366



170-1453



pomarańczowy  
orange

170-2361



170-1448



czerwony  
red

170-2359



170-1444



różowy  
pink

170-2362

500 ml



170-2303

1000 ml



ciemnoróżowy  
magenta

170-2357



170-1865



fioletowy  
violet

170-2276



170-1445



śląkityny  
cyan

170-2354



170-1442



jasnoniebieski  
light blue

170-2360



170-1446



granatowy  
navy blue

170-2277



zielony morski  
sea green

170-2365

500 ml



170-1451

1000 ml



jasnozielony  
light green

170-2364



170-1866



zielony  
green

170-2363



170-1450



jasnobrązowy  
light brown

170-2356



170-1867



brązowy  
brown

170-2355



170-1441



czarny  
black

170-2358



170-1443



## metaliczne metallic



## neonowe neon



## pastelowe pastel



## Farby tempery

- wodorozcieńczalne tempery
- idealne do nauki i do prac grupowych
- do malowania na wszystkich porowatych powierzchniach: papierze, kartonie, drewnie, polistyrenie itp.
- łatwo zmywalne, bezzapachowe
- można je dowolnie mieszać, co pozwala uzyskać nowe kolory i odcienie
- możliwość warstwowego malowania i korekt
- gotowe do użycia bez dodawania wody
- przechowywać w temperaturze 10–40°C
- szczelne plastikowe pojemniki
- pojemność: 6 x 25 ml

## Tempera paints

- water-soluble tempera paints
- perfect for beginners and collective works
- for rigid surfaces: paper, cardboard, wood, polystyrene
- easily washable, odorless
- can be mixed to obtain new colors and shades
- possibility of stratified painting and corrections
- ready to use with no addition of water
- store in 10–40°C
- tight plastic containers
- capacity: 6 x 25 ml

INDEKS INDEX ZESTAW SET EAN BARCODE

\* 170-1459 6 kol. col. 8 003511 022006



\* do wyczerpania zapasów while stock lasts



## Farby plakatowe

- zmywalne
- intensywne kolory
- pakowane w plastikowe pojemniki po 20 ml
- wyprodukowane w Polsce

## Poster paints

- washable
- vivid colors
- plastic containers, capacity 20 ml
- made in Poland



INDEKS INDEX ZESTAW SET EAN BARCODE

170-1869 6 kol. col. 5 903364 258177

170-1634 12 kol. col. 5 903364 258191





## Farby akwarelowe

- zmywalne
- jaskrawe kolory
- w zestawie pędzelek z nylonowym włosiem



## Water color paints

- washable
- vivid colors
- set includes nylon bristle brush

INDEKS	INDEX	ZESTAW	SET	EAN	BARCODE
170-1015		8 kol. x 2 g	8 col. x 2 g	5 903364 245665	
170-1012		12 kol. x 4 g	12 col. x 4 g	5 903364 245689	
170-1013		16 kol. x 2 g	16 col. x 2 g	5 903364 245702	
170-1014		24 kol. x 2 g	24 col. x 2 g	5 903364 245726	



## Farby akwarelowe na paletce

- zmywalne
- jaskrawe kolory
- w zestawie pędzelek z nylonowym włosiem oraz paletka z miejscem do mieszania kolorów



## Water color palette

- washable
- vivid colors
- set includes nylon bristle brush and palette providing place for mixing colors

INDEKS	INDEX	ZESTAW	SET	EAN	BARCODE
170-2373		12 kol.	col.	5 903364 276829	



## Farby wodne GR-FW10

- zmywalne
- w zestawie drewniany pędzelek z końskiego włosia
- trwałe, funkcjonalne etui z atrakcyjną owijką w kształcie sowy



## Water color GR-FW10

- washable
- set includes horse hair bristle brush with wooden handle
- durable case with distinctive owl-shaped wrapper

INDEKS	INDEX	ZESTAW	SET	EAN	BARCODE
170-2507		10 kol.	col.	5 903364 277482	

## Farby akwarelowe

- zmywalne
- jaskrawe kolory
- w zestawie pędzelek z nylonowym włosiem

## Water color paints

- washable
- vivid colors
- set includes nylon bristle brush



INDEKS INDEX ZESTAW SET

170-1551 12 kol. x 2 g 12 col. x 2 g

EAN BARCODE



## Kubek niekapek

- zabezpiecza miejsce prac plastycznych
- posiada zakrętkę z otwieraniem wieczkiem
- dodatkowe wgłębienia umożliwiają wygodne układanie pędzli np. w trakcie suszenia

## Painting cup

- protects working place
- cap with lid
- grooves for comfortable drying of brushes



INDEKS INDEX

EAN BARCODE

170-2340



kupując, wspierasz  
program dożywiania dzieci  
[www.pajacyk.pl](http://www.pajacyk.pl)



## Pędzle szkolne

- do farb akwarelowych, plakatowych i temper
- włosie kozy
- metalowe okucie
- plastikowa rękojeść

## School brushes

- for water color, poster & tempera paints
- goat bristle
- metal ferrule
- plastic handle



### w tubie

- opak. 72 szt. w sztywnej tubie PET

### drum

- 72 pcs. in durable PET drum



### GR-2252

- blister

### GR-2252

- blister card



INDEKS INDEX ROZMIAR SIZE EAN BARCODE

170-1428 1-6

170-1429 7-12

INDEKS INDEX ROZMIAR SIZE OPAK. PKG. EAN BARCODE

170-1417 1-6 6 szt. pcs.

170-1416 1-6 2 x 6 szt. pcs.





## Pędzle szkolne kolorowe

- zestaw pędzelków w krótkich, kolorowych uchwytach z przezroczystego plastiku
- nylonowe włosie w kolorze uchwytu
- do różnych technik malarskich
- poręczne – mieszczą się w każdym tornistrze

## Color school brushes

- brushes with short color handles made of transparent plastic
- nylon bristle in handle color
- for various techniques
- handy – fit in any school bag

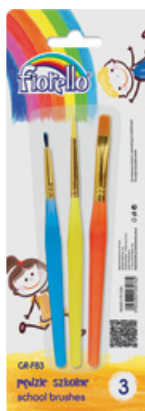

### GR-FB3

- fasony włosia:  
1 płaski, 2 okrągłe

### GR-FB3

- 3 various bristle types:  
1 flat, 2 round



### GR-FB5

- 5 różnych fasonów włosia:  
płaskie: szeroki, wąski, ścięty  
okrągłe: średni, wąski

### GR-FB5

- 5 various bristle types:  
flat: wide, narrow, chisel  
round: medium, narrow

INDEKS INDEX	OPAK. PKG.	EAN BARCODE
170-2256	3 szt. pcs.	5 903364 265762

INDEKS INDEX	OPAK. PKG.	EAN BARCODE
170-2215	5 szt. pcs.	5 903364 258948



kupując, wspierasz  
program dożywiania dzieci  
[www.pajacyk.pl](http://www.pajacyk.pl)



## Plastelina

- miękka, łatwa w kształtowaniu
- nie brudzi rąk
- wyraziste kolory
- waga 1 rolki koloru: 16 g (+/- 3 g)
- wyprodukowane w Polsce
- bezterminowa gwarancja

## Plasticine

- soft, easy to shape
- no dirty hands
- vivid colors
- 1 color roll: 16 g (+/- 3 g)
- made in Poland
- lifetime warranty



INDEKS INDEX	ZESTAW SET	EAN BARCODE
170-1430	6 kol. col.	5 903364 263409
170-1431	10 kol. col.	5 903364 263423
170-1432	12 kol. col.	5 903364 263430



## Plastelina PLASTY

- miękka, łatwa w kształtowaniu
- wyraziste kolory
- nie brudzi rąk
- nie wysycha, nie kurczy się
- nie zawiera glutenu

CE

## Plasticine PLASTY

- soft, easy to shape
- vivid colors
- no dirty hands
- no drying up, no shrinking
- gluten-free



- 6 kol. pastelowych, 100 g
- 6 col. pastel, 100 g

170-2525 



- 10 kol. klasycznych, 200 g
- 10 col. classic, 200 g

170-2526 



- 12 kol. klasycznych, 150 g
- 12 col. classic, 150 g

170-2527 

## PASTEL



- 3 kol. klasyczne, 180 g
- 3 col. classic, 180 g

170-2528 



- 12 kol. klasycznych, 12x150 g
- 12 col. classic, 12x150 g

170-2529 

**Masa do modelowania**

- samoutwardzalna masa modelarska
- gotowa do użycia, miękka, przyjemna w dotyku
- nieprzezroczysta
- łatwa do wyrabiania, wygładzania oraz do natożenia na dowolne podłoże (porowate powierzchnie najpierw zwilżyć wodą)
- nie wymaga wypalania, wysycha i utwardza się pod wpływem powietrza
- gotowe prace można udekorować farbami, np. temperą, lub pisakami
- idealna w domu i szkole, dla hobbystów oraz artystów, doskonała na warsztaty artystyczne
- pokrycie gotowej pracy lakierem ochronnym nada jej połysk i trwałość
- aby masa nie wysychała, należy przechowywać ją w szczelnym pojemniku
- waga 500 g

**Modelling material**

- self-hardening
- ready to use, soft, pleasant touch
- opaque
- easy to knead and to smoothen
- can be applied to any surface (porous surfaces: moisten with water first)
- air-dry: no baking required
- finished works can be decorated with paints, e.g. tempera, or felt-tip pens
- perfect for home and school use, for hobbyists and artists, for art workshops
- covering finished work with protective varnish gives it gloss and durability
- store in airtight container
- weight 500 g



**INDEKS INDEX**

170-2572

170-2571

**ZESTAW SET**

○ biała white

● terakota terracotta

**EAN BARCODE**



## Magiczny piasek

- można bawić się w domu
- miękka i gładka faktura
- aksamitny w dotyku
- bezpieczny dla dzieci i bezglutenowy
- nigdy nie wysycha i może być używany wielokrotnie
- ma specjalną strukturę, która pomaga w utrzymaniu czystości, nie klei się do rąk
- pozwala na łatwe modelowanie i formowanie kształtów rękami lub za pomocą foremek



### GR-F2500P

- piasek, kolor naturalny 2500 g
- pakowany w wiaderko

### GR-F2500P

- natural color sand 2500g
- packed in bucket

INDEKS INDEX EAN BARCODE

170-2279 

## Magic sand

- new indoor activity
- soft and smooth texture
- safe for kids, gluten-free
- never dries out, can be used repeatedly
- sticks only to itself, so it is essentially mess free
- easy to shape with hands, or by using molds and crafting tools



### cyferki GR-F600P

- piasek, kolor naturalny 600 g
- zawiera foremki

### numbers GR-F600P

- natural color sand 600g
- moulds included

INDEKS INDEX EAN BARCODE

★ 170-2281 

★ do wyczerpania zapasów while stock lasts



kupując, wspierasz program dożywiania dzieci [www.pajacyk.pl](http://www.pajacyk.pl)



### klocki GR-F712PK

- 3 x 200 g kolorowy + 100 g naturalny
- zawiera foremki

### blocks GR-F712PK

- 3 x 200g color + 100g natural
- moulds included

INDEKS INDEX EAN BARCODE

★ 170-2306 

★ do wyczerpania zapasów while stock lasts



### ZOO GR-F1010PB

- 500 g złoty + 500 g srebrny
- zawiera foremki

### ZOO GR-F1010PB

- 500g golden + 500g silver
- moulds included

INDEKS INDEX EAN BARCODE

★ 170-2325 

★ do wyczerpania zapasów while stock lasts



## Masa plastyczna CIASTO-PLASTO®

- masa plastyczna przeznaczona dla dzieci powyżej 4 lat
- łatwo poddaje się modelowaniu
- dostępna w żywych kolorach, które mogą być dowolnie mieszane
- miękka i lekka, nawet po wyschnięciu
- nie brudzi rąk i powierzchni
- nie łamie się, nie pęka i nie kruszy
- odbija się od różnych powierzchni jak piłka
- nie wymaga wypalania ani wypiekania, wysycha pod wpływem powietrza
- nie zawiera glutenu

## i-CLAY

- soft modeling clay for children over 4 years old
- easy to shape
- easily mixed vivid colors
- soft and lightweight, also after drying
- no dirty hands or surface
- no cracking, no breaking, no crumbling
- bounces like a ball
- air-dry: no baking required
- contains no gluten

## Mieszanie kolorów

Color mixing

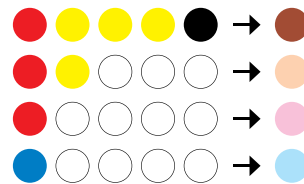
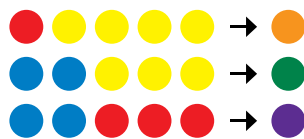

[www.ciastoplasto.pl](http://www.ciastoplasto.pl)



mieszanie kolorów  
color mixing

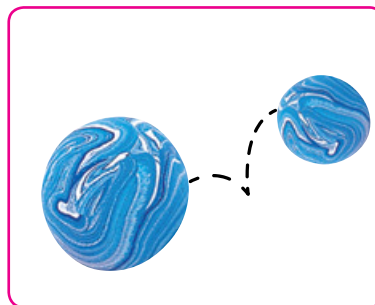

odbijanie  
bouncing



narzędzia  
tools

## Ciasto-Plasto®

• pojemność: 30 g

## i-Clay

• capacity: 30 g



AMOS®

INDEKS INDEX	KOLOR COLOR	EAN BARCODE
170-2254	○ biały fluo white fluo	5 903364 233648
170-1631	○ biały white	5 903364 231989
170-1632	● żółty yellow	5 903364 231996
170-1628	● pomarańczowy orange	5 903364 231958
170-1629	● czerwony red	5 903364 231965
170-1630	● fioletowy violet	5 903364 231972
170-1626	● niebieski blue	5 903364 231934
170-1627	● zielony green	5 903364 231941
170-1553	● czarny black	5 903364 231927



- biała masa świecąca w ciemności
- white glowing in the dark



## Ciasto-Plasto® IC18P4S

- w zestawie: 4 kolory (niebieski, neonowy zielony i różowy, fluorescencyjny biały), instrukcja
- pojemność: 4 x 18 g

## i-Clay IC18P4S

- set of 4 colors (blue, neon green and pink, fluorescent white), manual
- capacity: 4 x 18 g

INDEKS INDEX	EAN BARCODE
170-2227	8 802946 506927



## Ciasto-Plasto® IC18P4

- w zestawie: 4 kolory, instrukcja
- pojemność: 4 x 18 g

## i-Clay IC18P4

- set contains: 4 colors, manual
- capacity: 4 x 18 g

INDEKS INDEX	EAN BARCODE
170-2208	8 802946 501045



## Ciasto-Plasto® IC8P

- w zestawie: 8 kolorów, instrukcja
- pojemność: 8 x 18 g

## i-Clay IC8P

- set contains: 8 colors, manual
- capacity: 8 x 18 g

INDEKS INDEX	EAN BARCODE
170-1503	8 802946 500567

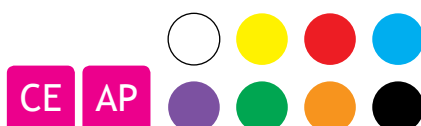



AMOS®



### Ciasto-Plasto® IC6PAL

- w zestawie: 5 kolorów, akcesoria, instrukcja
- pojemność: 5 x 18 g



### i-Clay IC6PAL

- set contains: 5 colors, accessories, manual
- capacity: 5 x 18 g



INDEKS INDEX

EAN BARCODE

★ 170-1022



★ do wyczerpania zapasów while stock lasts



### Ciasto-Plasto® IC6PT

- w zestawie: 6 kolorów, narzędzia, instrukcja
- pojemność: 6 x 18 g

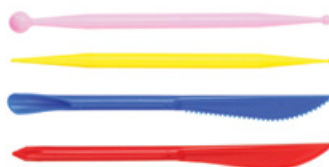

### i-Clay IC6PT

- set contains: 6 colors, tools, manual
- capacity: 6 x 18 g



INDEKS INDEX

EAN BARCODE

170-1023



### Ciasto-Plasto® Cukiernia IC6BK

- w zestawie: 6 kolorów, 2 farby Glass Deco, ściana cukierni, postacie
- pojemność Ciasto-Plasto: 6 x 18 g, pojemność Glass Deco: 2 x 10,5 ml

### i-Clay 'Bakery' IC6BK

- set contains: 6 colors, 2 Glass Deco paints, bakery walls, figures
- i-Clay capacity: 6 x 18 g, Glass Deco capacity: 2 x 10,5 ml



INDEKS INDEX

EAN BARCODE

★ 170-2104



★ do wyczerpania zapasów while stock lasts

## CIASTO-PLASTO® Puszysta Chmurka

- masa plastyczna przeznaczona dla dzieci powyżej 3 lat
- łatwo poddaje się modelowaniu
- miękka i lekka
- posiada oryginalną, delikatną strukturę chmurki
- nie wymaga wypalania ani wypiekania, wysycha pod wpływem powietrza
- nie brudzi rąk i powierzchni
- można samodzielnie tworzyć kolory używając pisaków lub farb
- idealna do tworzenia ornamentów, dekoracji, zabawek i innych kreatywnych czynności

## I-CLAY Soft Cloud

- soft modeling clay for children over 3 years old
- easy to shape
- soft and light
- cloud structure
- air dry: no baking required
- no dirty hands or surface
- easy to create colors with coloring markers
- ideal for making fancy ornaments, accessories, toys and creative artworks



AMOS®



struktura puszystej chmurki  
cloud structure

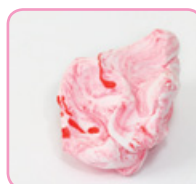

kolorowanie  
coloring

### SM70

- magiczna masa o pojemności 70 g netto w hermetycznym pudełeczku

### SM70

- magic clay 70 g net weight in airtight container

INDEKS INDEX

EAN BARCODE

\* 170-2370



CE

\* do wyczerpania zapasów while stock lasts



### SM70P-C

- w zestawie: magiczna masa o pojemności 70 g netto w hermetycznym pudełeczku, 3 foremki 3D, 8 foremek 2D, 2 kolorowe pisaki

### SM70P-C

- set contains: 3 3D molds, 8 2D molds, 2 markers, 70 g net weight of magic clay in airtight container



INDEKS INDEX

EAN BARCODE

\* 170-2371



CE

\* do wyczerpania zapasów while stock lasts





### Farby witrażowe Glass Deco

- wysokiej jakości farby witrażowe przeznaczone do samodzielnego wykonania witraży oraz dekoracji szkła, porcelany, lusterek, płytek ceramicznych i tworzyw sztucznych
- wyraziste kolory, łatwa aplikacja farb
- odklejalne – gotowy, wyschnięty wzór można przenosić z folii na inne powierzchnie
- możliwe jest łączenie farb witrażowych z innymi technikami: klejem z brokatem, Ciasto-Plasto

### Glass Deco paints

- high quality glass deco paints for creating individual stained glass and decorating glass, porcelain, mirrors, tiles and other surfaces
- vivid colors, easy application
- removable – dry pattern can be moved from foil to other surface
- possible to use with other techniques: Glitter Glue, i-Clay

### Instrukcja użycia

### How to use it



- Przezroczystą folię położyć na wzorniku
- Place transparent foil on pattern



- Rysować konturem po liniach wzoru, poczekać do wyschnięcia
- Draw contour, wait until lines get dry



- Obszary wewnątrz wzoru wypełnić farbą
- Fill contour with colors



- Po wyschnięciu odkleić wzór od folii podkładowej
- When dry, peel off your work from foil



- Nakleić na szybę, porcelanę, tworzywa sztuczne itp.
- Place it on glass, porcelaine, plastic, etc.



### Farby witrażowe GD10P6

#### ZAWIERA:

- czarny kontur
- 5 kolorów farb
- folie i wzorniki
- pojemność: 10,5 ml

### Glass Deco GD10P6

#### SET CONTAINS:

- black contour
- 5 paint colors
- foils and templates
- capacity: 10,5 ml



INDEKS INDEX

EAN BARCODE

170-1044



### Farby witrażowe GD10P10

#### ZAWIERA:

- czarny kontur
- 9 kolorów farb
- folie i wzorniki
- pojemność: 10,5 ml

### Glass Deco GD10P10

#### SET CONTAINS:

- black contour
- 9 paint colors
- foils and patterns
- capacity: 10,5 ml



INDEKS INDEX

EAN BARCODE

170-1692



## Farby witrażowe GD10P12R

### ZAWIERA:

- czarny kontur, złoty kontur
- 10 kolorów farb
- klej w sztyfcie 8 g
- folie i wzorniki
- pojemność: 10,5 ml

## Glass Deco GD10P12R

### SET CONTAINS:

- black contour, gold contour
- 10 paint colors
- glue stick 8 g
- foils and templates
- capacity: 10,5 ml



INDEKS INDEX

EAN BARCODE

170-1045



CE

AP



## Farby witrażowe GD22PW6

### ZAWIERA:

- czarny kontur
- 5 kolorów farb
- 2 wymienne końcówki
- folie i wzorniki
- pojemność: 22 ml

## Glass Deco GD22PW6

### SET CONTAINS:

- black contour
- 5 paint colors
- 2 extra nozzles
- foils and templates
- capacity: 22 ml



INDEKS INDEX

EAN BARCODE

170-2443



CE

AP



## Farby witrażowe GD22P7R

### ZAWIERA:

- czarny kontur 40 ml
- 6 kolorów farb po 22 ml (w tym 2 fluorescencyjne – świecą w ciemności)
- klej w sztyfcie 8 g
- 2 wymienne końcówki
- folie i wzorniki

## Glass Deco GD22P7R

### SET CONTAINS:

- black contour 40 ml
- 6 paint colors 22 ml (including 2 fluorescent)
- glue stick 8 g
- 2 extra nozzles
- foils and templates



INDEKS INDEX

EAN BARCODE

170-1049



CE

AP



# GLASS DECO

AMOS®

## Farby witrażowe GD22P10



**ZAWIERA:**

- czarny kontur 40 ml
- 9 kolorów farb po 22 ml
- 2 wymienne końcówki
- folie i wzorniki

## Glass Deco GD22P10

SET CONTAINS:

- black contour 40 ml
- 9 paint colors, 22 ml each
- 2 extra nozzles
- foils and templates



INDEKS INDEX

EAN BARCODE

170-2221



## Farby witrażowe GD22P13

**ZAWIERA:**

- 2 czarne kontury
- 8 kolorów klasycznych
- 3 kolory perłowe
- folie i wzorniki
- 2 wymienne końcówki
- pojemność: 13 x 22 ml

## Glass Deco GD22P13

SET CONTAINS:

- 2 black contours
- 8 classic colors
- 3 pearl colors
- foils and templates
- 2 extra nozzles
- capacity: 13 x 22 ml



INDEKS INDEX

EAN BARCODE

170-1050



## Farby witrażowe GD22D24

**ZAWIERA:**

- 5 kolorów x 4 butelki
- czarny kontur x 4 butelki
- pojemność: 22 ml

## Glass Deco GD22D24

SET CONTAINS:

- 5 colors x 4 bottles
- black contour x 4 bottles
- capacity: 22 ml



INDEKS INDEX

EAN BARCODE

170-1047



## Farby witrażowe GD22D24BG – kontury

**ZAWIERA:**

- czarny kontur x 16 butelek
- złoty kontur x 8 butelek
- pojemność 22 ml

## Glass Deco GD22D24BG contour

SET CONTAINS:

- 16 bottles of black contour
- 8 bottles of gold contour
- capacity: 22 ml



INDEKS INDEX

EAN BARCODE

170-2298



## Farby witrażowe breloki SD10B06-D1

### ZAWIERA:

- 6 gotowych witraży – breloków do pomalowania
- 6 kolorów farb
- pojemność: 10,5 ml



INDEKS INDEX

EAN BARCODE

170-1041



## Glass Deco Suncatchers SD10B06-D1

### SET CONTAINS:

- 6 ready-to-use suncatchers to paint
- 6 paint colors
- capacity: 10,5 ml

**GLASS DECO**

**AMOS**



## Farby witrażowe breloki SD10B06-D2

### ZAWIERA:

- 3 gotowe witraże – breloki do pomalowania
- 6 kolorów farb
- pojemność: 10,5 ml



INDEKS INDEX

EAN BARCODE

170-1548



## Glass Deco Suncatchers SD10B06-D2

### SET CONTAINS:

- 3 ready-to-use suncatchers to paint
- 6 paint colors
- capacity: 10,5 ml



## Farby witrażowe breloki

### ZAWIERA:

- 6 gotowych witraży – breloków do pomalowania
- 6 kolorów farb
- pojemność: 10,5 ml

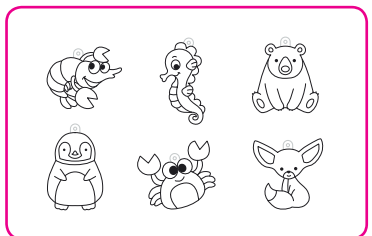

INDEKS INDEX

SYMBOL SYMBOL

ZESTAW SET

EAN BARCODE

\* 170-2449

SD10P6-A

Zwierzęta Animals

8 802946 508914

\* 170-2450

SD10P6-C

Autka Cars

8 802946 508921



## Glass Deco Suncatchers

### SET CONTAINS:

- 6 ready-to-use suncatchers to paint
- 6 paint colors
- capacity: 10,5 ml

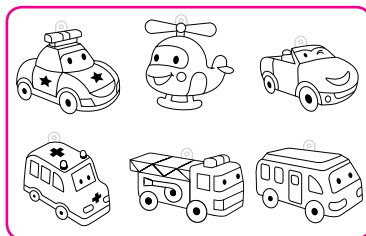

SD10P6-A

SD10P6-C

\* do wyczerpania zapasów while stock lasts

# GLASS DECO

## AMOS®



### Farby witrażowe Christmas

**ZAWIERA:**

- gotowe witraże-breloki z wzorami bożonarodzeniowymi do pomalowania
- farby witrażowe
- pojemność: 10,5 ml

### Glass Deco Christmas

**SET CONTAINS:**

- ready-to-use suncatchers to paint, Christmas patterns
- Glass Deco paints
- capacity: 10,5 ml



INDEKS INDEX	SYMBOL SYMBOL	ZESTAW SET	EAN BARCODE
170-2368	SD10P10-CH	10 kol., 12 witrażyków 10 col., 12 suncatchers	



### Farby witrażowe zestawy

**ZAWIERA:**

- 12 gotowych witraży-breloków do pomalowania
- 10 kol. farb
- pojemność: 10,5 ml

### Glass Deco sets

**SET CONTAINS:**

- 12 ready-to-use suncatchers to paint
- 10 paint colors
- capacity: 10,5 ml

gwiazdozbiory  
constellations



zwierzęta  
animals



INDEKS INDEX	SYMBOL SYMBOL	ZESTAW SET	EAN BARCODE
170-2565	SD10P10-CL	gwiazdozbiory constellations	
170-2564	SD10P10-ZA	zwierzęta animals	

## Witrażyki

- witraże-breloki do pomalowania
- obszary wewnątrz wzoru wypełnić farbami Glass Deco, ułożyć pokolorowane witraże na równej powierzchni i pozostawić do wyschnięcia
- gotowe witraże można połączyć żyłką lub łańcuszkiem
- w zestawie 6 witrażyków

## Suncatchers

- ready-to-use suncatchers to paint
- fill the contours with Glass Deco paints, put the colored suncatchers on even surface and let them dry
- when dry, suncatchers can be connected with a line or a chain
- 6 pieces set

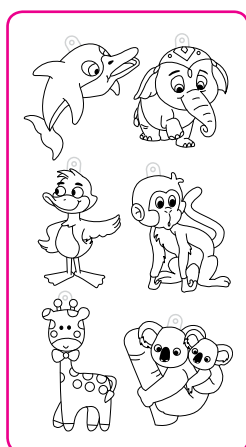

SCS6-AN



SCS6-LP

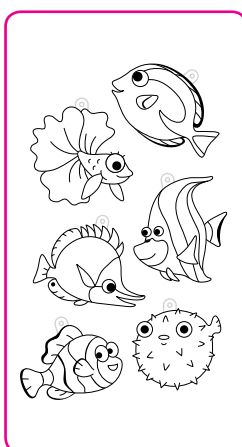

SCS6-TF

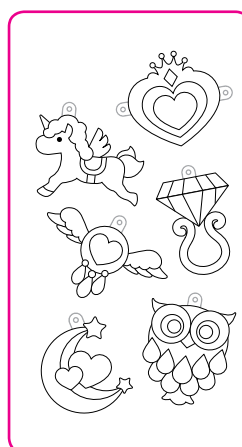

SCS6-JP



INDEKS	INDEX	SYMBOL	SYMBOL	ZESTAW	SET	EAN	BARCODE
★	170-2445	SCS6-AN	Animals			8	802946510900
★	170-2446	SCS6-LP	Little Princess			8	802946510887
★	170-2447	SCS6-TF	Tropical Fish			8	802946510917
★	170-2448	SCS6-JP	Jewel Pendant			8	802946510924



★ do wyczerpania zapasów while stock lasts

## Farby witrażowe Ice Jewelry GD10P10IJ

### ZAWIERA:

- 3 bransoletki
- 5 pierścionków
- 8 kolorów farb
- 2 kontury
- folie i wzorniki
- pojemność: 10 x 10,5 ml

## Glass Deco Ice Jewelry GD10P10IJ

### SET CONTAINS:

- 3 bracelets
- 5 rings
- 8 paint colors
- 2 contours
- foils and templates
- capacity: 10 x 10,5 ml



INDEKS	INDEX	EAN	BARCODE
170-2102		8	802946504503



### Farby witrażowe MY STYLE SD10P6-MSB

- zestaw do samodzielnego wykonania biżuterii – bransoletek i naszyjników

- ZESTAW ZAWIERA:  
6 witrażyków  
12 mini witrażyków  
300 korallików, żytkę  
6 kolorów farb  
pojemność: 6 x 10,5 ml

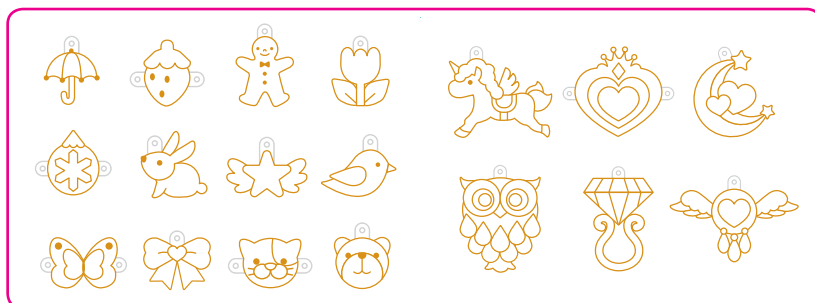

### Glass Deco MY STYLE SD10P6-MSB

- make your own jewelry: bracelets & necklaces
- SET CONTAINS:  
6 ready-to-use suncatchers to paint  
12 small ready-to-use suncatchers to paint  
300 beads, one string  
6 color paints  
capacity: 6 x 10,5 ml



INDEKS INDEX

EAN BARCODE

★ 170-2372



★ do wyczerpania zapasów while stock lasts

### Farby witrażowe POPART PA22P6-F

- kryjące, nieprzezroczyste farby witrażowe przeznaczone do samodzielnego wykonania witraży oraz dekoracji szkła, porcelany, lusterek, płytek ceramicznych i tworzyw sztucznych
- wyraziste kolory, łatwa aplikacja farb
- odklejalne z folii
- gotowy, wyschnięty wzór można przenosić z folii na inne powierzchnie
- możliwe jest łączenie farb witrażowych z innymi technikami: klejem z brokatem, Ciasto-Plasto

- ZESTAW ZAWIERA:  
3 ramki  
3 podkładki  
3 arkusze folii  
czarny kontur  
5 kolorów farb  
2 końcówki  
wzorniki, instrukcja  
pojemność: 22 ml



### Glass Deco POPART PA22P6-F

- vivid & opaque glass deco paints for creating individual stained glass and decorating glass, porcelain, mirrors, tiles and other surfaces
- vivid colors, easy application
- removable from foil
- dry pattern can be moved from foil to other surface
- possible to use with other techniques: Glitter Glue, I-CLAY
- SET CONTAINS:  
3 frames  
3 pads  
3 vinyl sheets  
black contour  
5 paint colors  
2 extra nozzles  
patterns  
instruction  
capacity: 22 ml



kryjące  
opaque



INDEKS INDEX

EAN BARCODE

★ 170-2444



★ do wyczerpania zapasów while stock lasts

### Klej z brokatem Glitter Glue

- dekoracyjny klej w płynie zawierający drobinki brokatu, przeznaczony do dekoracji papieru, kartonu, drewna i innych powierzchni
- wygodny: namaluj wzór za pomocą kleju i poczekaj aż zaschnie
- nie wymaga dodatkowych akcesoriów
- nie brudzi, nie rozsypuje się
- po zaschnięciu drobinki brokatu nie wykruszają się
- możliwe jest łączenie Glitter Glue z innymi technikami: farbami witrażowymi, Ciasto-Plasto

### Glitter Glue

- transparent decorative liquid glue with glitter
- for paper, cardboard, wood and other surfaces
- easy to use: draw a pattern and let it dry
- requires no extra accessories
- no mess, no spill
- after drying, glitter will not crumble up
- possible to use with Glass Deco paints, I-Clay



### Klej z brokatem confetti GCF10B5

- zawiera drobinki brokatu oraz kolorowe confetti
- w zestawie 5 kolorów
- pojemność: 5 x 10,5 ml

### Glitter Glue confetti GCF10B5

- contains glitter and colorful confetti
- 5 colors
- capacity: 5 x 10,5 ml

INDEKS INDEX

EAN BARCODE

170-1027



### Klej z brokatem neonowy GNE10B5

- neonowy klej zawiera drobinki brokatu
- w zestawie 5 kolorów neonowych
- pojemność: 5 x 10,5 ml

### Glitter Glue neon GNE10B5

- neon glue with glitter
- 5 colors
- capacity: 5 x 10,5 ml

INDEKS INDEX

EAN BARCODE

170-1034





# Glitter Glue

## AM•S®



### Klej z brokatem GCL10B6

- w zestawie 6 kolorów
- pojemność: 6 x 10,5 ml

### Glitter Glue GCL10B6

- 6 colors
- capacity: 6 x 10,5 ml



INDEKS INDEX

170-1031

EAN BARCODE



### Klej z brokatem GCL10B10

- w zestawie 10 kolorów
- pojemność: 10 x 10,5 ml

### Glitter Glue GCL10B10

- 10 colors
- capacity: 10 x 10,5 ml



INDEKS INDEX

170-2219

EAN BARCODE



### Klej z brokatem GCL10BK50

- w zestawie 6 kolorów  
w plastikowym wiadereczku
- pojemność: 50 x 10,5 ml

### Glitter Glue GCL10BK50

- 6 colors in plastic bucket
- capacity: 50 x 10,5 ml



INDEKS INDEX

170-2220

EAN BARCODE



### Klej z brokatem GCL22D24 GS

- w zestawie: złoty x 18 butelek,  
srebrny x 6 butelek
- pojemność: 24 x 22 ml

### Glitter Glue GCL22D24 GS

- set contains: golden x 18 bottles,  
silver x 6 bottles
- capacity: 24 x 22 ml

INDEKS INDEX

EAN BARCODE

170-1694



### Klej z brokatem GCL22D24

- w zestawie 6 kolorów x 4 butelki
- pojemność: 24 x 22 ml

### Glitter Glue GCL22D24

- 6 colors x 4 bottles
- capacity: 24 x 22 ml

INDEKS INDEX

EAN BARCODE

170-1033



### Klej z brokatem GCL120P5

- w zestawie 5 kolorów
- pojemność: 5 x 120 ml

### Glitter Glue GCL120P5

- 5 colors
- capacity: 5 x 120 ml

INDEKS INDEX

EAN BARCODE

170-1881



## Sypki brokat

- dekoracyjne drobinki brokatu
- namaluj odpowiedni kształt klejem i posyp brokatem
- przeznaczony do dekoracji papieru, kartonu, drewna i innych powierzchni

CE

## Glitter powder

- decorative glitter
- draw shape with glue and sprinkle it with glitter
- for paper, cardboard, wood and other surfaces



### GR-B6B61

- 6 kolorów x 6 g
- 6 colors x 6g

170-2239



### GR-B6B62

- 6 kolorów x 6 g
- 6 colors x 6g

170-2237



### GR-B7B2

- 2 kol. x 7 g
- 2 colors x 7g

170-2260



### GR-B5B8

- 8 kolorów x 4,5 g
- 8 colors x 4,5g

170-2238



### GR-B8B3

- 3 kolory x 8 g
- 3 colors x 8g

170-2235



### GR-B8B4

- 4 kolory x 8 g
- 4 colors x 8g

170-2378



### GR-B60R6

- 6 kolorów
- 60 g w stoiczku
- 6 colors
- 60g in the jar

170-2234



### GR-B60R6-2

- 6 pastelowych kolorów
- 60 g w stoiczku
- 6 pastel colors
- 60g in the jar

170-2261



### GR-B10B6

- 6 kolorów x 10 g
- 6 colors x 10g

170-2480

### GR-B5D48

- 8 kolorów x 6 fiolek (4,5 g)
- 8 colors x 6 vials (4,5g)

170-2236



## Klej z brokatem

- dekoracyjny bezbarwny klej w płynie zawierający drobinki brokatu
- wygodny: namaluj wzór za pomocą kleju i poczekaj aż zaschnie
- nie wymaga dodatkowych akcesoriów, nie brudzi, nie rozsypuje się
- po zaschnięciu drobinki brokatu nie wykruszają się
- przeznaczony do dekoracji papieru, kartonu, drewna i innych powierzchni



**GR-BK06B6**

- 6 kolorów x 6 ml
- 6 colors x 6 ml

170-2229



**GR-BK13B3**

- 3 kolory x 13 ml
- 3 colors x 13 ml

170-2233



**GR-KK13B5**

- zawiera drobinki confetti
- 5 kolorów x 13 ml
- contains colorful confetti
- 5 colors x 13 ml

170-2231



**GR-BK13B6**

- 6 kolorów x 13 ml
- 6 colors x 13 ml

170-2232



**GR-BK20B3**

- 3 kolory x 20 ml
- 3 colors x 20 ml

170-2230



**GR-BK20D24**

- 6 kolorów x 4 butelki
- 6 colors x 4 bottles

170-2228



**GR-BK60D12**

- 2 x 6 kol. x 60 ml
- 2 x 6 col. x 60 ml

170-2262

## Glitter Glue

- transparent decorative liquid glue with glitter
- easy to use: draw a pattern and let it dry
- no extra accessories, no mess, no spill
- after drying, glitter will not crumble up
- for paper, cardboard, wood and other surfaces

CE



**GR-BK75B2**

- 2 kol. x 75 ml
- 2 col. x 75 ml

\* 170-2263

\* do wyczerpania zapasów while stock lasts

## Cekiny oczka samoprzylepne

- oczka z ruchomymi czarnymi źrenicami

CE



GR-KE150-7

- 7 mm, 150 szt.
- 7 mm, 150 pcs.

170-2269



GR-KE80-12

- 12 mm, 80 szt.
- 12 mm, 80 pcs.

170-2270



GR-KE40-15

- 15 mm, 40 szt.
- 15 mm, 40 pcs.

170-2429



GR-KE15-20

- 20 mm, 15 szt.
- 20 mm, 15 pcs.

170-2430



## Cekiny oczka fluo

- oczka z ruchomymi czarnymi źrenicami
- świecące w ciemności

CE



GR-KE50-12F

- 12 mm, 50 szt.
- 12 mm, 50 pcs.

170-2560



GR-KE15-20F

- 20 mm, 15 szt.
- 20 mm, 15 pcs.

170-2563



GR-KE10-25F

- 25 mm, 10 szt.
- 25 mm, 10 pcs.

170-2562



GR-KE04-40F

- 40 mm, 4 szt.
- 40 mm, 4 pcs.

170-2561

## Wiggle eyes adhesive

- eyes with black moving pupils

## Wiggle eyes fluo

- eyes with black moving pupils
- glowing in the dark

CE



GR-C14-7

• 7x7 mm, 14 g



GR-C14-8

• 8x8 mm, 14 g



GR-C14-10

• 10x10 mm, 14 g



GR-C14-6C

• 6x6 mm, 14 g



GR-C14-6B

• 6x6 mm, 14 g

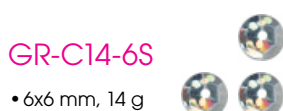

GR-C14-6S

• 6x6 mm, 14 g

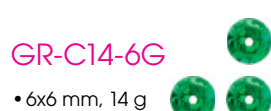

GR-C14-6G

• 6x6 mm, 14 g



GR-C14-13

• 13x13 mm, 14 g



GR-C14-14

• 14x14 mm, 14 g



GR-C14-15

• 15x15 mm, 14 g



GR-K145

• 6x6 mm, kwiaty  
• 6x6 mm, flowers



GR-K141

• 14x16 mm, choinki  
• 14x16 mm, Christmas trees



GR-K142

• 18x18 mm, śnieżynki  
• size 18x18 mm, snow flakes



GR-K143

• 19x19 mm, gwiazdki  
• 19x19 mm, stars



GR-K144

• 12x13 mm, serduszka  
• 12x13 mm, hearts



GR-C14-M

• miks, 14 g  
• assorted, 14 g

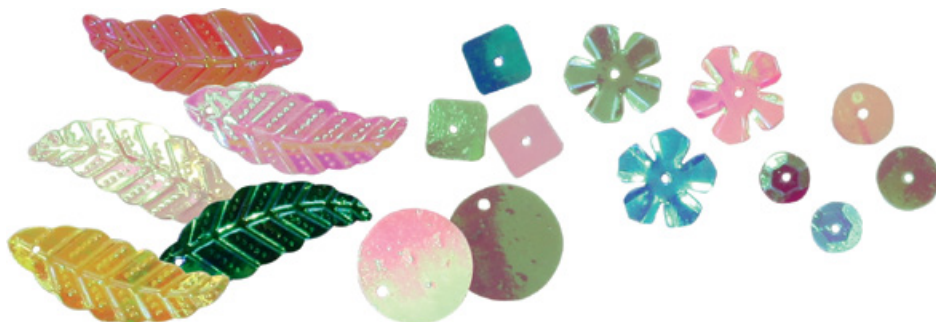

## Cekiny confetti

• w słoiczku z dozownikiem

CE



GR-C80-7

• 7x7 mm, 80 g

170-2539



GR-C50-14

• 14x14 mm, 50 g

170-2537



## Confetti sequins

• in jar with dispenser



GR-C90-8

• 8x8 mm, 90 g

170-2540



GR-C70-M

• miks assorted, 70 g

170-2538



GR-K251

• 5 x 2 g

170-2243



GR-K252

• 5 x 2 g

170-2244



GR-K8B8

• 8 x 8 g

170-2471



GR-K80R6

• 6 kolorów i kształtów  
• 80 g w słoiczku  
• 6 colors & shapes  
• 80g in a jar

170-2380



## Perełki samoprzylepne

- idealne do zdobienia projektów scrapbookingowych, kartek okolicznościowych, pudełek oraz wszelkich prac kreatywnych
- można naklejać pojedyncze elementy lub całe paseczki

CE

## Pearls adhesive

- perfect for scrapbooking projects, greeting cards, decorating boxes and all types of creative work
- possible to use whole strips or single elements only

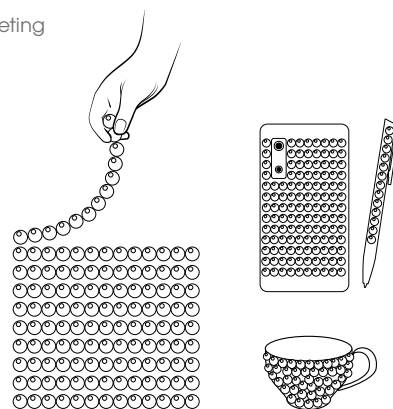

GR-PS162-3

170-2575

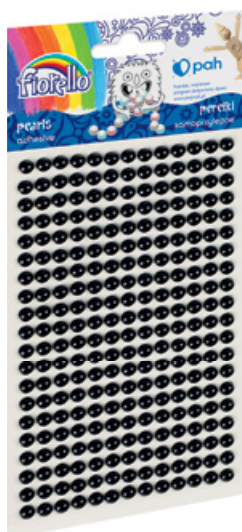

GR-PS162-10

170-2576

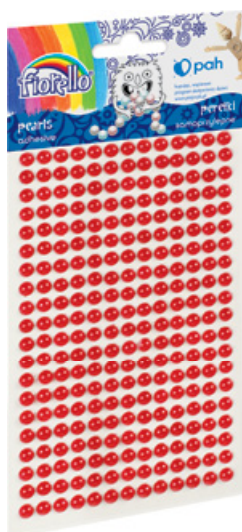

GR-PS162-4

170-2577

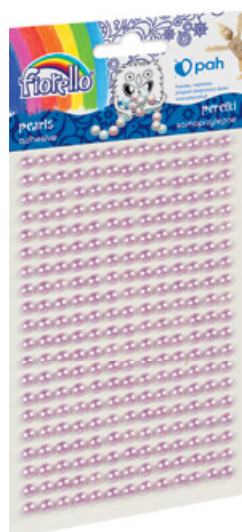

GR-PS162-7

170-2578

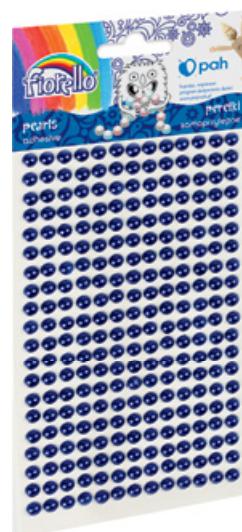

GR-S162-6

170-2579

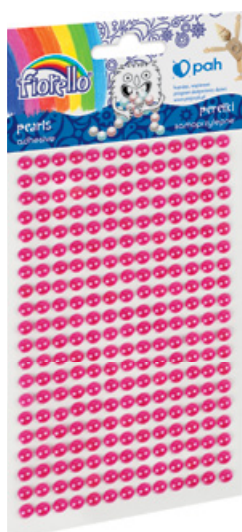

GR-PS162-8

170-2580



GR-PS162-9

170-2581

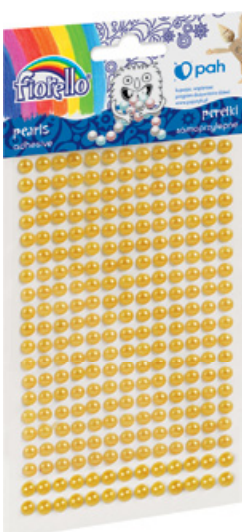

GR-PS162-5

170-2582

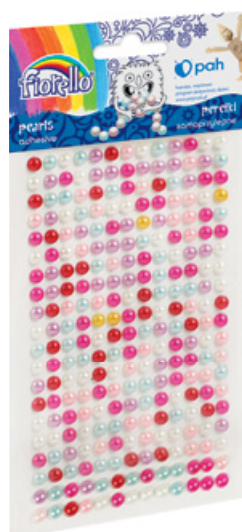

GR-PS162-1

170-2583

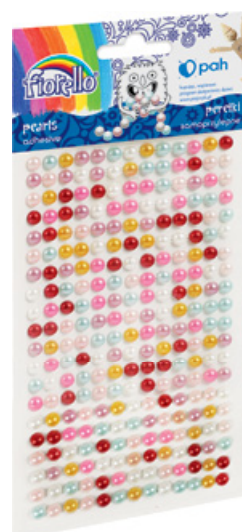

GR-PS162-2

170-2584





## Diamenciki samoprzylepne

- błyszczące diamenciki samoprzylepne w różnych kolorach i rozmiarach
- idealne do zdobienia projektów scrapbookingowych, kartek okolicznościowych, pudełek oraz wszelkich prac kreatywnych
- można naklejać pojedyncze elementy lub całe paseczki

## Diamonds adhesive

- glossy adhesive diamonds in various colors and sizes
- perfect for scrapbooking projects, greeting cards, decorating boxes and all types of creative work
- possible to use whole strips or single elements only

CE



GR-DS01

170-2397



GR-DS02

170-2398



GR-DS03

170-2399



GR-DS04

170-2400

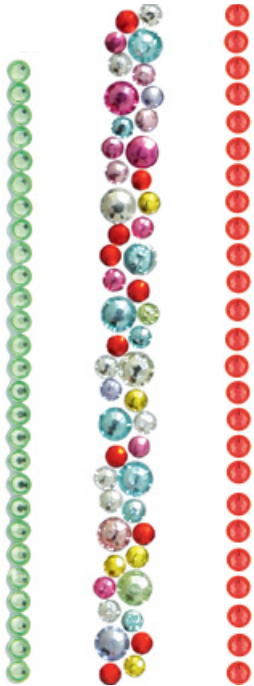

GR-DS05

170-2401



GR-DS06

170-2402



GR-DS07

170-2403



GR-DS08

170-2404

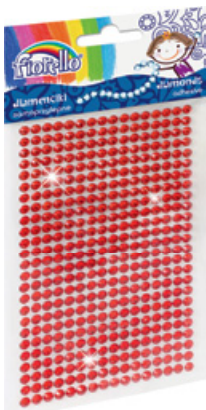

GR-DS039-1

170-2391

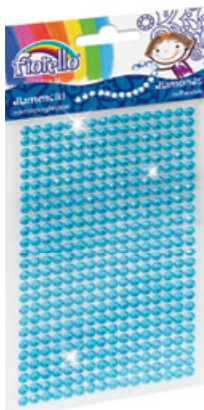

GR-DS039-2

170-2392

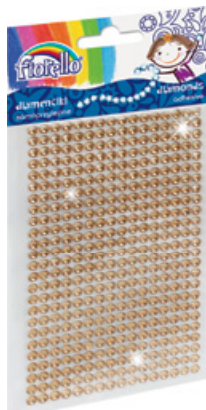

GR-DS039-3

170-2393



GR-DS039-4

170-2394

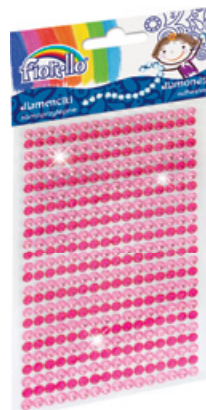

GR-DS040

170-2395



GR-DS041

170-2396



CE



GR-DS081-1

170-2461  
5 903364 278861

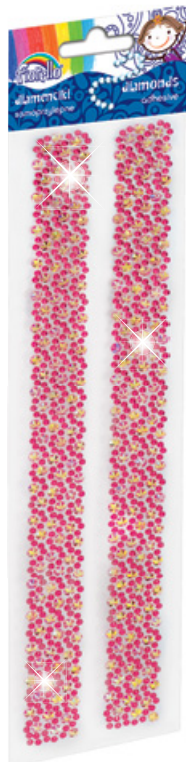

GR-DS081-2

170-2462  
5 903364 278885

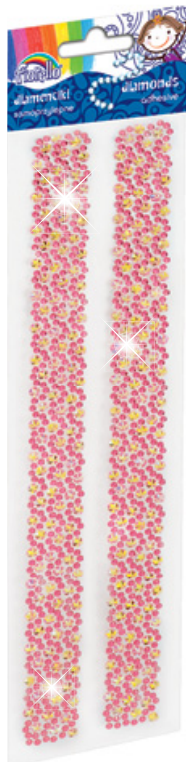

GR-DS081-3

170-2463  
5 903364 278908



GR-DS081-4

170-2464  
5 903364 278922



GR-DS081-5

170-2465  
5 903364 278946

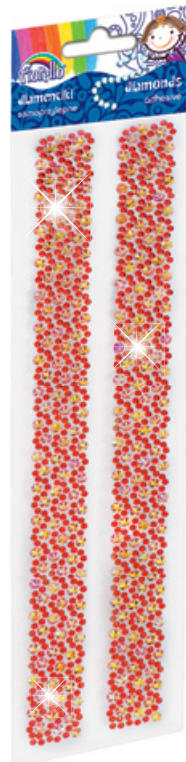

GR-DS081-6

170-2466  
5 903364 278960

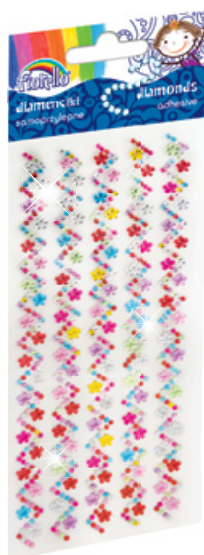

GR-DS070

170-2460  
5 903364 278847

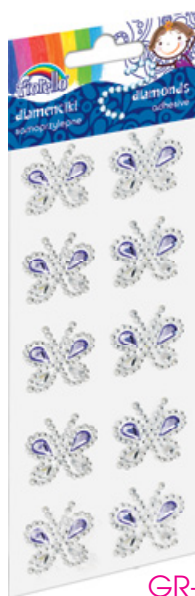

GR-DS089

170-2475  
5 903364 279028



GR-DS085

170-2467  
5 903364 278984



GR-DS137

170-2468  
5 903364 279004

CE



GR-DS090-01

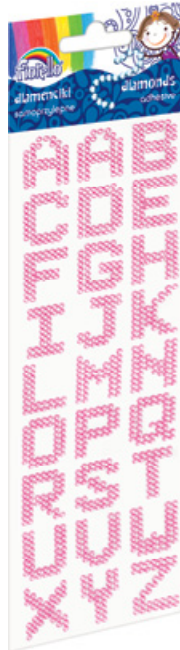

GR-DS090-02

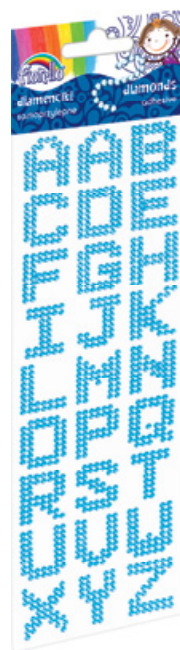

GR-DS090-03

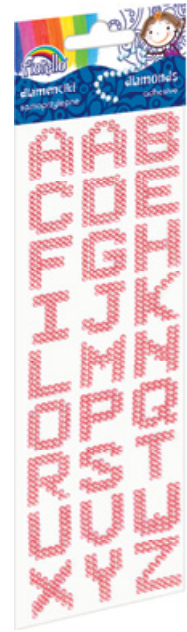

GR-DS090-04



**Naklejki wypukłe**

Convex stickers

- samoprzylepne naklejki wypełnione miękką pianką
- idealne do zdobienia projektów scrapbookingowych, kartek okolicznościowych, pudełek oraz wszelkich prac kreatywnych

- adhesive stickers filled with soft foam
- perfect for scrapbooking projects, greeting cards, decorating boxes and all types of creative work

CE

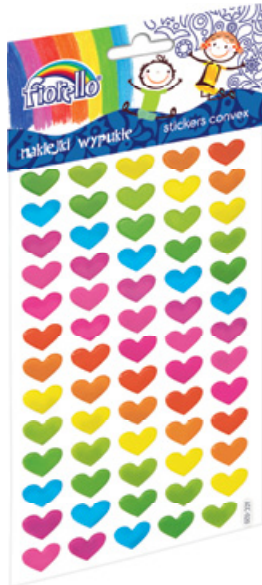

GR-NP139

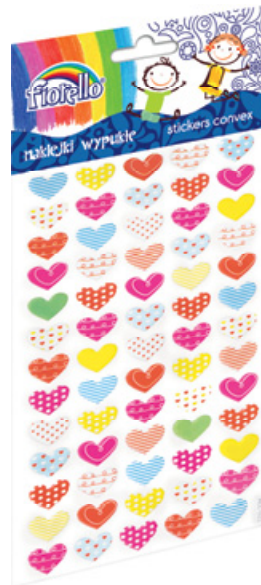

GR-NP145

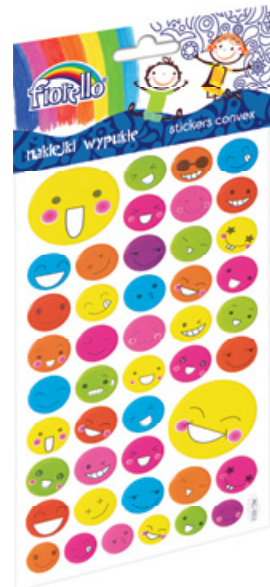

GR-NP147



CE



GR-NP140

170-2456



GR-NP138

170-2484



GR-NP141

170-2457



GR-NP127

170-2481



GR-NP134

170-2483



kupując, wspierasz program dożywiania dzieci

[www.pajacyk.pl](http://www.pajacyk.pl)



## Naklejki piankowe

- samoprzylepne, wykonane z miękkiej pianki
- idealne do zdobienia projektów scrapbookingowych, kartek okolicznościowych, pudełek oraz wszelkich prac kreatywnych

## Foam stickers

- adhesive stickers, made of soft foam
- ideal for scrapbooking projects, greeting cards, decorating boxes and all types of creative work

CE



GR-NP125

170-2383



GR-NP129

170-2385



GR-NP128

170-2384



GR-NP130

170-2386



GR-NP133

170-2387



GR-NP290

170-2388



GR-NP299

170-2389



## Naklejki dekoracyjne 3D

- samoprzylepne naklejki papierowo-foliowe z elementami brokatowymi
- efekt przestrzenny dzięki kostkom, które unoszą elementy naklejki
- idealne do zdobienia projektów scrapbookingowych, kartek okolicznościowych, pudełek oraz wszelkich prac kreatywnych

CE



GR-NP018

170-2470



## Decor 3D stickers

- adhesive stickers made of paper&foil, with glittery elements
- 3D effect by special cubes rising the sticker's elements
- perfect for scrapbooking projects, greeting cards, decorating boxes and all types of creative work



GR-NP015

170-2469



## Naklejki filcowe



- samoprzylepne, wykonane z miękkiego filcu
- idealne do zdobienia projektów scrapbookingowych, kartek okolicznościowych, pudełek oraz wszelkich prac kreatywnych

## Felt stickers

- adhesive stickers, made of soft felt
- perfect for scrapbooking projects, greeting cards, decorating boxes and all types of creative work

CE



GR-NP332

170-2390



## Ozdoby filcowe



- wykonane z miękkiego filcu
- idealne do zdobienia projektów scrapbookingowych, kartek okolicznościowych, pudełek oraz wszelkich prac kreatywnych

## Felt deco

- made of soft felt
- perfect for scrapbooking projects, greeting cards, decorating boxes and all types of creative work

CE



GR-CH323

170-2459



GR-CH301

170-2458



CE



GR-WD717

- spinacz sowa 41x22 mm, 10 szt.
- clamp owl 41x22 mm, 10 pcs.

170-2515



GR-WD723

- spinacz kwiatek 38x26 mm, 6 szt.
- clamp flower 38x26 mm, 6 pcs.

170-2516



GR-WD647

- spinacz 30x5 mm, 25 szt.
- clamp 30x5 mm, 25 pcs.

170-2517



GR-WD645

- spinacz 48x7 mm, 12 szt.
- clamp 48x7 mm, 12 pcs.

170-2518



GR-WD915

- spinacz BN, 10 szt.
- clamp Xmas, 10 pcs.

170-2534



GR-WD699

- spinacz BN, 10 szt.
- clamp Xmas, 10 pcs.

170-2535



GR-WD449

- spinacz BN filc, 6 szt.
- clamp Xmas felt, 6 pcs.

170-2536

CE



GR-WD122

- guzik kwiatek 10 szt.:  
6 x 20 mm i 4 x 25 mm
- button flower 10 pcs.:  
6 x 20 mm and 4 x 25 mm

170-2520



GR-WD791

- serduszko 28 mm, 15 szt.
- heart 28 mm, 15 pcs.

170-2521



GR-WD607

- guzik owoce 20 mm, 20 szt.
- button fruit 20 mm, 20 pcs.

170-2519



GR-WD605

- sowa 20x30 mm, 15 szt.
- owl 20x30 mm, 15 pcs.

170-2522



GR-WD059

- śnieżynka 40 mm, 10 szt.
- snowflake 40 mm, 10 pcs.

170-2533



GR-WD858

- śnieżynka 30 mm, 10 szt.
- snowflake 30 mm, 10 pcs.

170-2532



GR-WD811

- gwiazdka 29 mm, 15 szt.
- star 29 mm, 15 pcs.

170-2530



GR-WD824

- anioł 25x30 mm, 15 szt.
- angel 25x30 mm, 15 pcs.

170-2531



## Druciki kreatywne

• średnica 6 mm, długość 30 cm, 15 szt.

## Chenille craft stems

• diameter 6 mm, 30 cm long, 15 pcs.

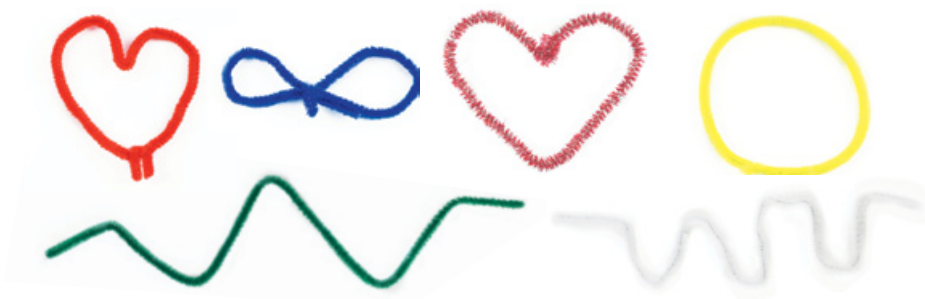

INDEKS INDEX	KOLOR COLOR	EAN BARCODE
170-2544	○ biały white	8 595083 521853
170-2545	● czerwony red	8 595083 521914
170-2546	● niebieski blue	8 595083 522140
170-2547	● zielony green	8 595083 522072
170-2548	● żółty yellow	8 595083 557906
170-2541	5 kol. miks 5 col. assorted	8 595083 521426
170-2542	5 kol. miks metaliczne 5 col. assorted metallic	8 595083 521754

## Pompony kreatywne

• w odcieniach koloru głównego, 120 szt.

## Craft pom poms

• shades of dominant color, 120 pcs.



INDEKS INDEX	KOLOR COLOR	EAN BARCODE
170-2549	● czerwony red	8 595083 557203
170-2550	● niebieski blue	8 595083 523796
170-2551	● zielony green	8 595083 523840
170-2552	● żółty yellow	8 595083 557289



• miks kolorów i rozmiarów, 78 szt.

• assorted colors & sizes, 78 pcs.

INDEKS INDEX	KOLOR COLOR	EAN BARCODE
170-2543	miks assorted	8 595083 522942

## Wzorki w taśmie

- oryginalne wzorki - ożywią notatki
- do wszelkich prac artystycznych: zdobienia zeszytów, kartek, pocztówek, prezentów itd.
- samoprzylepne

## Pattern tape

- unique patterns bring notes to life
- for all types of creative work: decorating notebooks, greeting cards, postcards, gifts etc.
- self-adhesive



CE 6 mm  
4 m

INDEKS INDEX	SYMBOL SYMBOL	RODZAJ TYPE	EAN BARCODE
* 170-2408	GR-FT1	lew morski sea lion	5 903364 253196
* 170-2409	GR-FT2	miś polarny polar bear	5 903364 253219
* 170-2410	GR-FT3	świnka piggy	5 903364 253233
* 170-2411	GR-FT4	pingwin penguin	5 903364 253257



\* do wyczerpania zapasów while stock lasts

## Taśmy dekoracyjne

- odrywane ręcznie bez konieczności użycia nożyczek
- do kolorowania markerami permanentnymi na bazie alkoholu oraz długopisami: GRAND Fluo GR-91-6 lub Carioca Fiorella (dekorację należy pozostawić do wyschnięcia)
- rozmiar 48 mm x 5 m
- samoprzylepne

## Decorative tapes

- easy to tear off by hand – no need to use scissors
- for coloring with permanent alcohol-based markers or with pens: GRAND Fluo GR-91-6 and Carioca Fiorella (leave the work to dry after coloring)
- size 48 mm x 5 m
- self-adhesive

CE

INDEKS INDEX	RODZAJ TYPE	EAN BARCODE
* 170-2322	safari safari	5 903364 234980
* 170-2321	adventure adventure	5 903364 234973
* 170-2320	mandala mandala	5 903364 234966



\* do wyczerpania zapasów while stock lasts

## Fartuszek ochronny

- chroni ubrania przed zabrudzeniem w trakcie zabaw artystycznych
- łatwy do zakładania i zdejmowania
- długie rękawy wykończone gumką
- dwie kieszenie z przodu na drobiazgi
- miejsce na podpis
- regulowane zapięcie na rzep
- wodoodporny
- można prać w 30°C
- pakowany w woreczek z zawieszka

## Apron

- designed to give free rein to creativity without being afraid of stains
- easy to put on and off
- long sleeves with elastic band
- two front pockets
- name tag
- adjustable velcro closure
- waterproof
- washable at 30°C
- packed in a bag with hanger



INDEKS	INDEX	ZESTAW	SET	EAN	BARCODE
170-2557		2-4 lata	years	8 003511 331009	
170-2558		5-8 lat	years	8 003511 331016	



## Przybornik na długopisy „Kosz” 1760

- pojemnik na długopisy i kredki w kształcie kontenera na śmieci
- przydatny w utrzymaniu porządku na każdym biurku
- dostępny w kilku kolorach
- rozmiar: 105x80x140 mm
- bez wyposażenia

## Pen holder 'Trash can' 1760

- pens and crayons holder
- unusual shape of garbage can
- helps to keep order on every desk
- available in several colors
- size: 105x80x140 mm
- not equipped



INDEKS	INDEX	EAN	BARCODE
120-1929		8 690857 017607	

## Kolorowanka

- dwustronna
- z motywem zwierząt, literek oraz cyferek
- pomocna w nauce alfabetu, liczenia oraz języka angielskiego (każdy obrazek ma swoją angielską nazwę)
- w zestawie 10 pisaków Carioca Joy
- pakowana w wygodne foliowe etui z uchwytem
- 16 stron do kolorowania

## Coloring book

- two-sided
- animals, letters and numbers help to learn the alphabet, counting and English language (each picture has its English name)
- set contains 10 Carioca Joy fibre pens
- packed in convenient plastic case with handle
- 16 pages

**CARIOCA®**

CE

INDEKS INDEX

160-2206

EAN BARCODE



## Kolorowanka w rolce

- samoprzylepna, odlepialna – może być przyklejana i odklejana wiele razy
- nie pozostawia śladów po odklejeniu
- z motywem zwierząt i literek – pomocna w nauce alfabetu oraz języka angielskiego (każdy obrazek ma swoją angielską nazwę)
- wspaniała zabawa dla małego artysty
- rolka mini: zestaw 6 kredek Tita mini (10x85 cm) rolka maxi: zestaw 8 kredek Tita + kolorowanka w rolce maxi (30x198 cm)

## Coloring roll

- self-adhesive, stick & re-stick – it can be stucked and peeled off many times
- no residue when removed
- animals and letters help to learn the alphabet and English language (each picture has its English name)
- great fun for small artist
- mini roll: set of 6 Tita mini color pencils and coloring roll (10x85 cm) maxi roll: set of 8 Tita color pencils and coloring roll (30x198 cm)

**CARIOCA®**

CE

INDEKS INDEX

ROLKA ROLL

KREDKI COLOR PENCILS

EAN BARCODE

160-2205

mini 10x85 cm

mini, 6 kol. col.



160-2204

maxi 30x198 cm

8 kol. col.





## Zestawy plastyczne – walizeczki

- zestawy tematyczne
- w każdej walizeczce bogaty zbiór produktów do prac plastycznych

### Craft boxes

- ideas for art activities
- every case with wide range of craft utensils



### zestaw plastyczny **POZNAJĘ EMOCJE**

- balony emoty 12 szt.
- naklejki wypukłe buźki kolorowe 45 szt.
- stempelki buźki 26 szt.
- ruchome oczka 40 szt.



#### Set 'EMOTIONS'

- balloons faces 12 pcs.
- stickers convex faces 45 pcs.
- stamps faces 26 pcs.
- wiggle eyes 40 pcs.

INDEKS INDEX SYMBOL SYMBOL EAN BARCODE

170-2553

GR-ZF1



### zestaw plastyczny **POZNAJĘ LITERKI**

- naklejki wypukłe literki 47 szt.
- diamentki samoprzylepne literki 27 szt.
- stempelki literki 32 szt.
- spinacze drewniane 12 szt.



#### Set 'LETTERS'

- stickers convex letters 47 pcs.
- diamonds adhesive letters 27 pcs.
- stamps letters 32 pcs.
- wooden clamps 12 pcs.

INDEKS INDEX SYMBOL SYMBOL EAN BARCODE

170-2554

GR-ZF2



### zestaw plastyczny **NAKLEJKI** na każdą okazję

- naklejki piankowe
- naklejki wypukłe buźki kolorowe 45 szt.
- naklejki wypukłe serca 65 szt.
- diamentki samoprzylepne paseczki
- ruchome oczka 150 szt.

#### Set 'STICKERS'

- foam stickers
- stickers convex faces 45 pcs.
- stickers convex hearts 65 pcs.
- diamonds adhesive strips
- wiggle eyes 150 pcs.

INDEKS INDEX SYMBOL SYMBOL EAN BARCODE

170-2555

GR-ZF3



## zestaw plastyczny RYSOWANIE

- kredki ołówkowe Super Soft 14 kol.
- kredki świecowe trójkątne grube 12 kol.
- pisaki dwustronne BiMarker 12 kol.
- wzorki w taśmie



INDEKS INDEX SYMBOL SYMBOL EAN BARCODE

170-2556

GR-ZF4



## Set 'DRAWING'

- color pencils 14 col.
- wax crayons triangular jumbo 12 col.
- double-sided markers BiMarker 12 col.
- pattern tape



Rzeczywisty wygląd i skład zestawów plastycznych może różnić się od prezentowanego.

The actual appearance and composition of the Craft Boxes may be different from the one presented.

## Piórnik zwijany na kredki ołówkowe

- piórn timer zwijany uszyty z wytrzymałego, grubo tkanego materiału
- miejsce na 24 kredki i inne akcesoria
- posiada wewnętrzną zakładkę, która zabezpiecza przed wypadaniem wyposażenia i chroni je przed uszkodzeniem
- wiązany na gruby, pleciony sznurek
- idealny na prezent, dla pasjonatów rysowania i ekologii
- nie zawiera wyposażenia



INDEKS INDEX

170-2559

EAN BARCODE



## Pencil case roll-up

- roll-up pencil case made of durable, thick woven fabric
- for 24 crayons and other accessories
- internal tab prevents utensils from falling out and protects them
- tied with a thick, braided rope
- perfect for a gift, for drawing and ecology enthusiasts
- no accessories included



## Zestawy kreatywne

- do stworzenia własnych, wyjątkowych ozdób

## Creative sets

- create unique necklaces & bracelets

### Drewniane koralki

- w zestawie: kuferek, drewniane koralki, gumki
- przejrzysty kuferek pozwala łatwo posortować elementy, może być też torebką na inne drobiazgi

### Wooden beads

- set includes: jewelry chest, wooden beads, cords
- transparent chest enables easy separating of accessories, it can be handbag for other accessories as well



CE

INDEKS INDEX SYMBOL SYMBOL EAN BARCODE

170-2585

GR-F8141



### Bizuteria

- w zestawie: koralki, alfabet: koralki/charmsy, żyłki, gumka, akcesoria
- ponad 400 elementów

### Jewelry

- set includes: beads, alphabet beads/charms, cords, accessories
- 400+ elements



CE

INDEKS INDEX SYMBOL SYMBOL EAN BARCODE

170-2586

GR-F8254



## Zestaw 3D do kolorowania Create & Color Elephant

- zabawny kartonowy model 3D: koloruj i łącz elementy
- łatwo zmywalne pisaki
- może służyć także jako niebanalny pojemnik na przybory
- zestaw zawiera:  
18 pisaków Carioca Joy i Jumbo  
kartonowe elementy do stworzenia modelu słonia

## Coloring set 3D Create & Color Elephant

CARIOCA®

- funny Pop-Up models to color and assemble
- washable color pens
- it can be used as creative pencil case
- set includes:  
18 Carioca Joy and Jumbo felt tip pens  
cardboard elements to create 3D elephant model

CE



### Elephant

170-2426  
\*  8 003511 429027



## Zestaw 3D do kolorowania Create & Color Planny

- zabawny kartonowy model 3D: koloruj i łącz elementy
- łatwo zmywalne pisaki
- zestaw zawiera:  
10 pisaków dwustronnych Carioca Birello  
kartonowe elementy do stworzenia modelu samolotu

## Coloring set 3D Create & Color Planny

- funny Pop-Up models to color and assemble
- washable color pens
- set includes:  
10 Carioca Birello double-tip felt tip pens  
cardboard elements to create 3D plane model

CE



### Planny

170-2427  
\*  8 003511 429041



\* do wyczerpania zapasów while stock lasts



**Zestaw Puzzle do kolorowania**

- duże kartonowe puzzle z konturami do kolorowania
- dwustronne – dwa wzory
- rozmiar puzzli po złożeniu: 70x100 cm
- łatwo zmywalne pisaki
- zestaw zawiera:  
24 pisaki Carioca Joy z cienką końcówką  
12 pisaków Carioca Jumbo z grubą końcówką  
35 puzzli

CE

**Set of jigsaw puzzles for coloring**

- large cardboard puzzles with patterns for coloring
- double-sided – two patterns
- size of image: 70x100 cm
- washable color pens
- set contains:  
24 Carioca Joy color pens with fine tip  
12 Carioca Jumbo color pens with maxi tip  
35 puzzles

24 sztuki pcs  
12 sztuk pcs



Adventures

170-2341



City & Jungle

170-2342



Monsters

170-2491



Empire

170-2492



\* do wyczerpania zapasów while stock lasts

**rozmiar 1:1**

scale 1:1

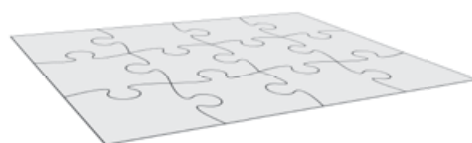

rozmiar po złożeniu: 70x100 cm  
size of image: 70x100 cm

## Piórniki z wyposażeniem

- wewnątrz wysokiej jakości przybory Carioca
- zamykane na zamek błyskawiczny

### jednokomorowy

- zawiera:
  - 6 pisaków Carioca Neon
  - 3 długopisy Corvina Arrow (czerwony, czarny, niebieski)
  - 2 ołówki HB
  - długopis wymazywalny Carioca
- żywe, neonowe kolory
- można prać w 40°C
- wymiary: 23x10x5 cm



INDEKS INDEX

171-1027

EAN BARCODE



INDEKS INDEX

171-1028

EAN BARCODE



## jednokomorowy do kolorowania

- zawartość:
  - 6 pisaków Carioca Doodles
  - 6 kredek ołówkowych Carioca Tita
  - pisak do tkanin Carioca Fabric
  - długopis Corvina 51
  - linijka
  - temperówka
  - gumka do wymazywania Carioca
- wymiary: 19,5x13,2x2,5 cm

## one-zipper, for coloring

- contains:
  - 6 Carioca Doodles felt tip pens (fine nib)
  - 6 color pencils Carioca Tita
  - fineliner Carioca Fabric
  - Corvina 51 ball pen
  - ruler
  - pencil sharpener
  - pencil eraser Carioca
- dimensions: 19,5x13,2x2,5 cm



## Piórniki z wyposażeniem

Pencil cases equipped

CARIOCA®

### dwukomorowy do kolorowania

- zawartość:  
18 pisaków Carioca Doodles  
12 kredek ołówkowych Carioca Tita  
2 pisaki do tkanin Carioca Fabric  
ołówek HB Carioca  
długopis Corvina 51  
linijka  
temperówka  
gumka do wymazywania Carioca
- wymiary: 19,5x13,2x4,7 cm

### two-zipper, for coloring

- contains:  
18 Carioca Doodles felt tip pens (fine nib)  
12 color pencils Carioca Tita  
2 fineliners Carioca Fabric  
Carioca HB pencil  
Corvina 51 ball pen  
ruler  
pencil sharpener  
pencil eraser Carioca
- dimensions: 19,5x13,2x4,7 cm



INDEKS INDEX

EAN BARCODE

171-1029



CE



**CARIOCA®**  
Fabric

+ TEXTILE  
PERMANENT MARKER

pisak do tkanin wewnątrz!



**WIĘCEJ KOLORÓW ZNAJDZIESZ  
W MARKERACH DO TKANIN  
NA STR. 208**

Need more colors?  
Check Fabric Markers CARIOCA at page 208!



### Blok rysunkowy

- format A4 lub A3
- wyprodukowano w Polsce

### Drawing pad

- A4 or A3 format
- made in Poland

	INDEKS INDEX	FORMAT FORMAT	ZAWIERA SHEETS	EAN BARCODE
<b>A4</b>	150-1241	A4	20 kartek sheets	5 903364 242022
<b>A3</b>	150-1261	A3	20 kartek sheets	5 903364 242930



### Blok rysunkowy kolorowy

- format A4 lub A3
- wyprodukowano w Polsce

### Color drawing pad

- A4 or A3 format
- made in Poland

	INDEKS INDEX	FORMAT FORMAT	ZAWIERA SHEETS	EAN BARCODE
<b>A4</b>	150-1436	A4	16 kartek sheets	5 903364 254773
<b>A3</b>	150-1437	A3	16 kartek sheets	5 903364 254780



### Blok techniczny

- format A4 lub A3
- wyprodukowano w Polsce

### Technical pad

- A4 or A3 format
- made in Poland

	INDEKS INDEX	FORMAT FORMAT	ZAWIERA SHEETS	EAN BARCODE
<b>A4</b>	150-1090	A4	10 kartek sheets	5 903364 242725
<b>A3</b>	150-1262	A3	10 kartek sheets	5 903364 242947



### Blok techniczny kolorowy

- format A4 lub A3
- wyprodukowano w Polsce

### Color technical pad

- A4 or A3 format
- made in Poland

	INDEKS INDEX	FORMAT FORMAT	ZAWIERA SHEETS	EAN BARCODE
<b>A4</b>	150-1438	A4	8 kartek sheets	5 903364 254797
<b>A3</b>	150-1439	A3	8 kartek sheets	5 903364 254803

## Plótno malarskie w bloku Canvas

- trzykrotnie gruntowane akrylem, gotowe do malowania plótno bawełniane
- przeznaczone do malowania farbami olejnymi, akrylowymi, plakatowymi oraz pastelami olejnymi i pisakami
- wygodny w użyciu jednostronnie klejony blok
- dla profesjonalistów i hobbystów
- 100% bawełna
- bezkwasowe
- gramatura ± 300 g/m<sup>2</sup>
- 10 arkuszy

## Canvas artist's pad

- cotton canvas, triple primed with acrylic paint & markers
- for oil, acrylic, poster paint, for oil pastels & markers
- comfortable pad, short side glued
- for professionals and hobbyists
- 100% cotton
- acid-free
- weight ± 300 gsm
- 10 sheets



INDEKS INDEX	SYMBOL SYMBOL	ROZMIAR SIZE	EAN BARCODE
150-1435	GR-F0912	227x300 mm	5 903364 238360
150-1444	GR-F1216	305x406mm	5 903364 238421
150-1445	GR-F1620	406x508 mm	5 903364 238438
150-1446	GR-F1824	457x610 mm	5 903364 238445



akryl i olej  
acrylic & oil



farba plakatowa  
poster paint



pastele olejne  
oil pastel



pisaki  
markers

## Bibuła gładka – blok



- format A4
- blok zawiera 60 arkuszy gładkiej bibuły (5x12 kolorów)

## Bibuła gładka



- wymiary arkusza: 50x35 cm
- rolka: 12 arkuszy gładkiej bibuły (12 kolorów)
- opak. 5 rolek

## Tissue paper pad

- sheet format: A4
- 60 sheets of tissue paper (5x12 colors)

## Tissue paper

- sheet size: 50x35 cm
- roll: 12 sheets of tissue paper (12 colors)
- packaging 5 rolls

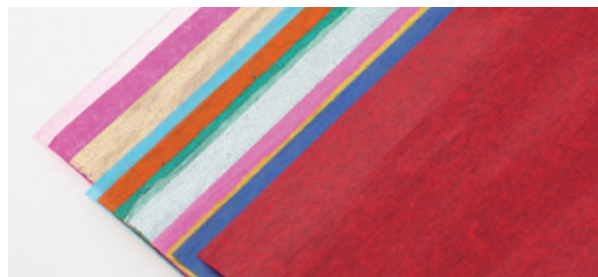

INDEKS INDEX	EAN BARCODE	A4
170-2346	5 903364 256890	

INDEKS INDEX	EAN BARCODE	Color palette
170-1989	5 903364 256848	



## Bibuła dekoracyjna marszczona

- wymiary arkusza: 200x50 cm
- spełnia normy dot. zawartości nonylphenolu
- opak. 10 rolek

## Crepe paper

- sheet size: 200x50 cm
- conforms to nonylphenol content standards
- packaging 10 rolls

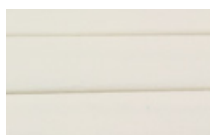

biały  
white  
170-1614  
5 903364 256302

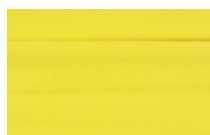

jasnożółty  
light yellow  
170-1987  
5 903364 256364



żółty  
yellow  
170-1612  
5 903364 256326



ciemnożółty  
dark yellow  
170-2307  
5 903364 256579

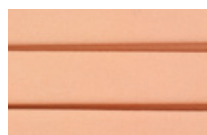

łososiowy  
salmon pink  
170-1878  
5 903364 256227

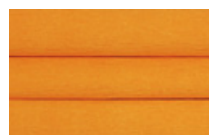

pomarańczowy jasny  
light orange  
170-2308  
5 903364 256593



pomarańczowy  
orange  
170-1617  
5 903364 256166



ciemnopomarańczowy  
dark orange  
170-1984  
5 903364 256388



czerwony  
red  
170-1607  
5 903364 256241



ciemnoczerwony  
dark red  
170-2309  
5 903364 256616

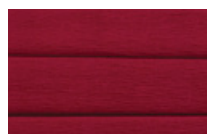

bordowy  
maroon  
170-1988  
5 903364 256401



jasnoróżowy  
light pink  
170-1608  
5 903364 256203



ciemnoróżowy  
dark pink  
170-1985  
5 903364 256425



fioletowy  
violet  
170-1877  
5 903364 256449

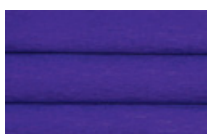

chabrowy  
mauve blue  
170-2310  
5 903364 256630

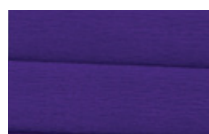

ciemnofioletowy  
dark violet  
170-1980  
5 903364 256289



jasnoniebieski  
light blue  
170-1982  
5 903364 256463



błękitny  
sky blue  
170-2311  
5 903364 256654



niebieski  
blue  
170-1616  
5 903364 256043

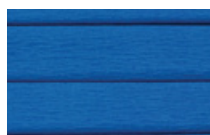

ciemnoniebieski  
dark blue  
170-1983  
5 903364 256487



granatowy  
navy blue  
170-1615  
5 903364 256067



jasnozielony  
light green  
170-1986  
5 903364 256500

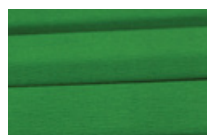

zielony  
green  
170-1611  
5 903364 256142



ciemnozielony  
dark green  
170-1610  
5 903364 256128



oliwkowy  
olive green  
170-2313  
5 903364 256692

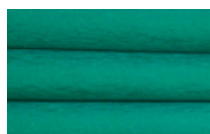

morski  
sea green  
170-2312  
5 903364 256678

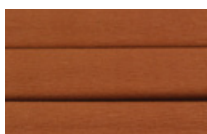

jasnobrązowy  
light brown  
170-1981  
5 903364 256524

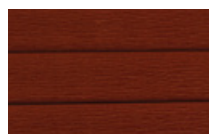

brązowy  
brown  
170-1876  
5 903364 256081

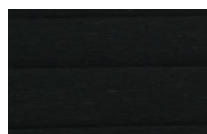

czarny  
black  
170-1613  
5 903364 256029

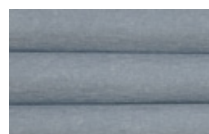

szary  
grey  
170-2314  
5 903364 256715

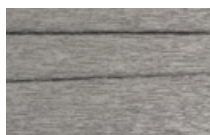

srebrny  
silver  
170-1619  
5 903364 256265

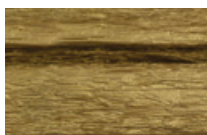

złoty  
golden  
170-1618  
5 903364 256104

kolory w zestawach colors in sets



zestaw 1  
set 1  
170-1605  
5 903364 256333



zestaw 2  
set 2  
170-1606  
5 903364 256555



zestaw 3  
set 3  
170-2509  
5 903364 256999

## Bibuła dekoracyjna krótka

- wymiary arkusza: 200x25 cm
- spełnia normy dot. zawartości nonylphenolu
- opak. 10 rolek



zestaw 1  
set 1

170-2300

5 903364 256876

## Short crepe paper

- sheet size: 200x25 cm
- conforms to nonylphenol content standards
- packaging 10 rolls



zestaw 2  
set 2

170-2301

5 903364 256883



## Akcesoria do balonów

## Balloon accessories



INDEKS INDEX	PRODUKT PRODUCT	OPAK. PKG.	EAN BARCODE
170-1601	pompka pump	1 szt. pc.	
170-1687	nakładka cap	100 szt. pcs.	
170-1686	patyczek stick	100 szt. pcs.	



## Balony emoty

- wykonane w 100% z wytrzymałego naturalnego lateksu
- opak. 12 sztuk, rozmiar 12"



## Balony fantazyjne

### Fancy balloons



### Balloons emots

- made of 100% durable natural latex
- 12 pcs., size 12"

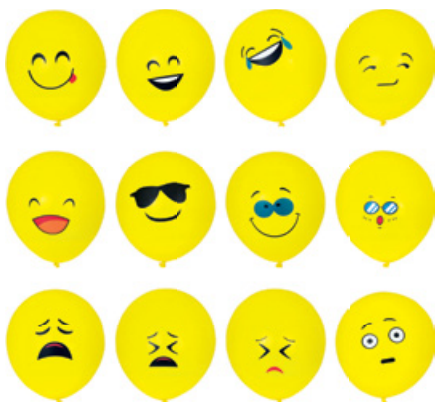
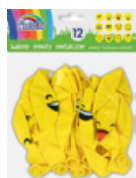

CE

INDEKS INDEX	RODZAJ TYPE	EAN BARCODE
170-2328	klasyczne classic	
170-2347	metaliczne metallic	



INDEKS INDEX	RODZAJ TYPE	OPAK. PKG.	EAN BARCODE
170-1595	„bomba wodna” water bomb	120 szt. pc.	
170-1597	długie do modelowania modelling balloons	100 szt. pcs.	
170-1598	piłki punch balls	4 szt. pcs.	





## Balony tradycyjne

- wykonane w 100% z wytrzymałego naturalnego lateksu
- możliwość napełniania hełmem
- dostępne w różnych rozmiarach i kolorach
- pakowane po 100 szt.

## Traditional balloons

- 100% natural rubber
- helium filling possible
- different sizes and colors available
- bag of 100 pcs.

### metaliczne

### metallic



biały perłowy  
white pearl

10" 170-1562



12" 170-1578



kremowy  
cream

10" 170-1589



12" 170-1582



jasnożółty  
light yellow

10" 170-1676



12" 170-1682



rózowy  
pink

10" 170-2122



12" 170-2121



czerwony  
red

10" 170-1587



12" 170-1588



niebieski  
blue

10" 170-1565



12" 170-1646



jasnozielony  
light green

10" 170-1685



12" 170-1683



zielony  
green

10" 170-1566



12" 170-1585



złoty  
golden

10" 170-1568



12" 170-1586



srebrny  
silver

10" 170-2502



12" 170-2503



czarny  
black

10" 170-2501



12" 170-2504



pomarańczowy  
orange

12" 170-2510



### zestawy kolorystyczne

- miks kolorów balonów metalicznych, pastelowych lub neonowych

### color sets

- assorted metallic, pastel or neon colors



100 szt. 100 pcs.

12 szt. 12 pcs.

#### metaliczne metallic

10" 170-1678



12" 170-1684



#### pastelowe pastel

10" 170-1673



12" 170-1681



#### neonowe neon

10" 170-1604



#### metaliczne metallic

10" 170-2451



12" 170-2455



#### pastelowe pastel

10" 170-2453



12" 170-2454



#### neonowe neon

10" 170-2452



**arts artystyczne**

## Pastele suche

- suche kredki do nastrojowych rysunków na papierze
- przekrój kwadratowy
- intensywne, nasycone kolory
- kwadratowy kształt i boczne ułożenie kredki pozwala na pokrywanie dużych obszarów za jednym pociągnięciem
- można mieszać i cieniować kolory
- aby uniknąć rozmazania rysunku, należy użyć utrwalacza

## Dry pastels

- dry, square pastels for romantic drawings on paper
- square cross-section
- intensive, saturated colors
- square shape and side grip enable to cover large areas with one stroke
- colors can be mixed and shaded
- use fixative to avoid smudging

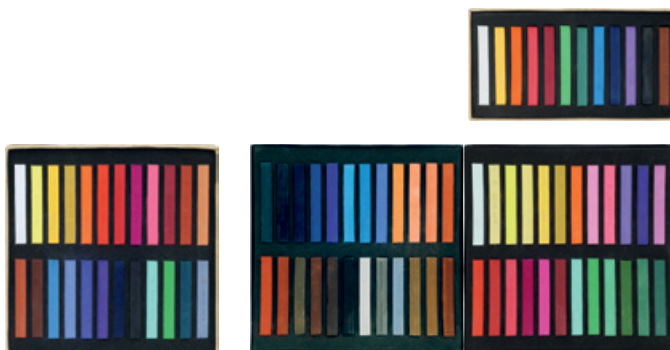

INDEKS INDEX	SYMBOL SYMBOL	ZESTAW SET	EAN BARCODE
170-2090	F2012	12 kol. col.	
170-2091	F2024	24 kol. col.	
170-1887	F2048	48 kol. col.	

## Pastele olejne

- przekrój okrągły
- umożliwiają płynne, gładkie rysowanie
- kredki są wytrzymałe – niełatwo je złamać
- kolory można nakładać na siebie i korygować, używając terpentyny jako rozpuszczalnika
- obrazy są trwałe i odporne na światło

## Oil pastels

- round cross-section
- enable to draw fluently and smoothly
- durable – resistant to breaking
- colors can be put on one another and corrected with turpentine as a solvent
- paintings are durable and resistant to light



INDEKS INDEX	SYMBOL SYMBOL	ZESTAW SET	EAN BARCODE
170-1884	E1220	12 kol. col.	
170-1885	E1223	16 kol. col.	
170-1886	E1225	25 kol. col.	

## Farby akwarelowe

- farby transparentne
- mogą być mieszane bezpośrednio na papierze
- łatwo rozpuszczalne w wodzie
- przeznaczone do lekkich, zwiewnych obrazków, pejzaży, portretów malowanych na porowatym papierze
- pakowane w trwałe, aluminiowe tubki, chroniące przed wysychaniem i zapobiegające utlenianiu się zapachu farb

## Water colors

- transparent paints
- colors may be mixed directly on paper
- water-soluble
- for light and ethereal pictures, landscapes, portraits painted on porous paper
- durable metal tubes prevent paints from drying



INDEKS INDEX	SYMBOL SYMBOL	ZESTAW SET	TUBKA TUBE	EAN BARCODE
170-1907	E1325	12 kol. col.	5 ml	6 901893 200253
170-1908	E1336B	12 kol. col.	12 ml	6 901893 220367
170-1909	E1338B	18 kol. col.	12 ml	6 901893 220381



## Farby akrylowe

- dobrze i szybko schną, nie pękają
- doskonale przepuszczają powietrze
- odporne na wilgoć
- odporne na blaknięcie – kolory są intensywne i trwałe
- przeznaczone do malowania, pisania na papierze, drewnie, materiałach, cemencie, bambusie
- po zakończonej pracy pędzle należy umyć lub zamoczyć w wodzie
- pakowane w trwałe, aluminiowe tubki, chroniące przed wysychaniem i zapobiegające utlenianiu się zapachu farb

## Acrylic colors

- fast drying, no cracking
- excellent air circulation
- resistant to humidity
- fade-resistant: colors are durable and vivid
- for painting and writing on paper, wood, fabric, cement, bamboo
- brushes should be washed or soaked in water
- durable metal tubes prevent paints from drying



INDEKS INDEX	SYMBOL SYMBOL	ZESTAW SET	TUBKA TUBE	EAN BARCODE
170-2153	81306B	6 kol. col.	30 ml	6 901893 803027
170-1910	812B	12 kol. col.	12 ml	6 901893 620129
170-1911	818B	18 kol. col.	12 ml	6 901893 620181



## Farby akrylowe 816B

- pojemność 120 ml

INDEKS INDEX	KOLOR COLOR	EAN BARCODE
170-2593	biały titanium white	6 901893 032984
170-2594	czarny black	6 901893 033318
170-2595	czerwony crimson red	6 901893 033073

## Acrylic colors 816B

- capacity 120 ml

INDEKS INDEX	KOLOR COLOR	EAN BARCODE
170-2596	niebieski ultramarine blue	6 901893 033134
170-2597	zielony sap green	6 901893 033233
170-2598	żółty lemon yellow	6 901893 033011



## Farby olejne

- z trwałych pigmentów, mają konsystencję pasty
- dokładnie kryją, można je retuszować
- namalowane obrazy długo zachowują świeże kolory
- przeznaczone do malowania na zagruntowanym płótnie, deskach, płytach pilśniowych, płytach wiórowych, metalu
- pozwalają uzyskać efekt matu lub błysku, półprzezroczystości, przenikania barw i tworzenia złożonych struktur
- po zakończonej pracy pędzle należy umyć w terpentynie
- pakowane w trwałe, aluminiowe tubki, chroniące przed wysychaniem i zapobiegające ulatnianiu się zapachu farb

## Oil colors

- made of durable pigments, pulp consistency
- can be retouched
- colors remain fresh for long
- for painting on grounded canvas, wooden board, fibreboard, chipboard, metal
- allow to obtain matt or glossy effect, translucence or color passage and to create complex structure
- brushes should be washed in turpentine
- durable metal tubes prevent paints from drying



INDEKS INDEX	SYMBOL SYMBOL	ZESTAW SET	TUBKA TUBE	EAN BARCODE
170-1915	E1386B	12 kol. col.	12 ml	 6 901893 120865
170-1916	E1388B	18 kol. col.	12 ml	 6 901893 120889

## Farby gwasz

- farba wodna z domieszką kredy, nadającej właściwości kryjące
- możliwość nakładania warstw pozwala na korekty obrazu
- po wyschnięciu kolory jaśnieją, a powierzchnia jest matowa
- przeznaczone do malowania plakatów, delikatnych wzorów, ilustracji książek, szkiców do obrazów olejnych
- najlepiej malować na papierze gładkim, kartonie, tekturze białej lub kolorowej o odpowiedniej grubości, by uniknąć przesiąkania farb
- pakowane w trwałe, aluminiowe tubki, chroniące przed wysychaniem i zapobiegające ulatnianiu się zapachu farb

## Gouache colors

- water-borne paint with addition of chalk which makes it opaque
- possibility of applying multiple layers enables to correct painting
- when dried up, colors brighten and surface becomes matt
- for painting posters, delicate ornaments, book illustrations, drafts for oil paintings
- best effect on smooth paper, white or colored cardboard thick enough to prevent from soaking through
- durable metal tubes prevent paints from drying



INDEKS INDEX	SYMBOL SYMBOL	ZESTAW SET	TUBKA TUBE	EAN BARCODE
170-1912	7312B	12 kol. col.	12 ml	 6 901893 420125
170-1913	7318B	18 kol. col.	12 ml	 6 901893 420187

## Pędzle GR-B212-5

- do farb olejnych i akwareli
- artystyczne: 2 płaskie i 3 szpiczaste
- drewniana rękojeść, metalowe okucie
- jasne włosie – szczecina, żółte włosie – kozie
- opak. blister 5 szt.

## Brushes GR-B212-5

- for oil paints and water color
- artistic, 2 flat and 3 pointy
- wooden handle, metal ferrule
- bright – bristle, yellow – goat
- blister card 5 pcs.

Grand®



INDEKS INDEX

EAN BARCODE

170-2257



## Pędzle GR-B212-6

- do farb olejnych i akwareli
- artystyczne: 3 płaskie i 3 okrągłe
- drewniana rękojeść, metalowe okucie
- jasne włosie – szczecina, ciemne włosie – końskie
- opak. blister 6 szt.

## Brushes GR-B212-6

- for oil paints and water color
- artistic, 3 flat and 3 round
- wooden handle, metal ferrule
- bright – bristle, brown – horsehair
- blister card 6 pcs.

Grand®



INDEKS INDEX

EAN BARCODE

170-2258



## Pędzle GR-252 A

- artystyczne, precyzyjne
- drewniana rękojeść, metalowe okucie, kozie włosie
- opak. blister 6 szt.

## Brushes GR-252 A

- artistic, precise
- wooden handle, metal ferrule, goat bristle
- blister card 6 pcs.

Grand®

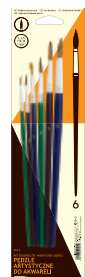

INDEKS INDEX

EAN BARCODE

170-1420



## Pędzle GR-252 B

- artystyczne, precyzyjne
- drewniana rękojeść, metalowe okucie, kozie włosie
- opak. blister 6 szt.

## Brushes GR-252 B

- artistic, precise
- wooden handle, metal ferrule, goat bristle
- blister card 6 pcs.

Grand®



INDEKS INDEX

EAN BARCODE

170-1421





**Grand®**

### Pędzle GR-252

- artystyczne, precyzyjne
- drewniana rękojeść, metalowe okucie, kozie włosie
- opak. blister 12 szt.



1-12  
rozmiar  
size

### Brushes GR-252

- artistic, precise
- wooden handle, metal ferrule, goat bristle
- blister card 12 pcs.

INDEKS INDEX

EAN BARCODE

170-1419



**Grand®**

### Pędzle GR-582

- do akwareli i retuszu
- artystyczne, okrągłe
- drewniana rękojeść, metalowe okucie, szczecina
- opak. blister 12 szt.



1-12  
rozmiar  
size

### Brushes GR-582

- for water color and retouche
- artistic, round
- wooden handle, metal ferrule, bristle
- blister card 12 pcs.

INDEKS INDEX

EAN BARCODE

170-1414



**Grand®**

### Pędzle GR-882 Y

- do akwareli i retuszu
- artystyczne, okrągłe
- drewniana rękojeść, metalowe okucie, szczecina
- opak. blister 9 szt.



0,2,4,6,8,  
10,12,14,16  
rozmiar  
size

### Brushes GR-882 Y

- for water color and retouche
- artistic, round
- wooden handle, metal ferrule, bristle
- blister card 9 pcs.

INDEKS INDEX

EAN BARCODE

170-1426



**Grand®**

### Pędzle GR-882 B

- do farb akwarelowych
- artystyczne, płaskie
- drewniana rękojeść, metalowe okucie, szczecina
- opak. blister 9 szt.



0,2,4,6,8,  
10,12,14,16  
rozmiar  
size

### Brushes GR-882 B

- for water color
- artistic, flat
- wooden handle, metal ferrule, bristle
- blister card 9 pcs.

INDEKS INDEX

EAN BARCODE

170-1415



## Pędzle GR-685 B

- do farb olejnych
- artystyczne, płaskie
- drewniana rękojeść, metalowe okucie, szczecina
- opak. blister 6 szt.

INDEKS INDEX

EAN BARCODE

170-1424



5 903364 245313



2, 4, 6,  
8, 10, 12  
rozmiar  
size

## Brushes GR-685 B

- for oil paints
- artistic, flat
- wooden handle, metal ferrule, bristle
- blister card 6 pcs.

Grand®



## Pędzle GR-577 A

- do farb olejnych
- artystyczne, płaskie
- drewniana rękojeść, metalowe okucie, szczecina
- opak. blister 5 szt.

INDEKS INDEX

EAN BARCODE

170-1422



5 903364 244057



0, 4, 8,  
12, 16  
rozmiar  
size

## Brushes GR-577 A

- for oil paints
- artistic, flat
- wooden handle, metal ferrule, bristle
- blister card 5 pcs.

Grand®



## Pędzle GR-579

- do farb olejnych
- artystyczne, płaskie
- drewniana rękojeść, metalowe okucie, szczecina
- opak. blister 12 szt.

INDEKS INDEX

EAN BARCODE

170-1423



5 903364 244071



1-12  
rozmiar  
size

## Brushes GR-579

- for oil paints
- artistic, flat
- wooden handle, metal ferrule, bristle
- blister card 12 pcs.

Grand®



## Pędzle GR-685 A

- do farb olejnych
- artystyczne, płaskie
- drewniana rękojeść, metalowe okucie, szczecina
- opak. blister 6 szt.

INDEKS INDEX

EAN BARCODE

170-1425



5 903364 245290



1, 3, 5,  
7, 9, 11  
rozmiar  
size

## Brushes GR-685 A

- for oil paints
- artistic, flat
- wooden handle, metal ferrule, bristle
- blister card 6 pcs.

Grand®





## Palety malarskie

- drewniane podkłady do mieszania farb
- produkt foliowany

## Painting palettes

- wooden palettes for mixing paints
- foiled



### Paleta owalna

#### Oval palette

INDEKS INDEX	SYMBOL SYMBOL	ROZMIAR SIZE	EAN BARCODE
170-1995	G83303	21,5x30 cm	
170-1996	G83304	30x40 cm	



### Paleta prostokątna

#### Rectangular palette

INDEKS INDEX	SYMBOL SYMBOL	ROZMIAR SIZE	EAN BARCODE
170-1994	G83313	21,5x30 cm	
170-1993	G83314	30x40 cm	

## Tuby kreślarskie

- wykonane z trwałego tworzywa sztucznego
- posiadają pasek na ramię
- lekkie i wytrzymałe

## Drawing tubes

- made of durable material
- with shoulder strap
- durable, lightweight



GR-0070



GR-0108



GR-0133

INDEKS INDEX	SYMBOL SYMBOL	ŚREDNICA DIAMETER	DŁUGOŚĆ LENGTH	EAN BARCODE
170-2336	GR-0070	Ø 7 cm	46–70 cm	
170-1917	GR-0108	Ø 8,5 cm	64–108 cm	
170-1918	GR-0133	Ø 11 cm	78–133 cm	

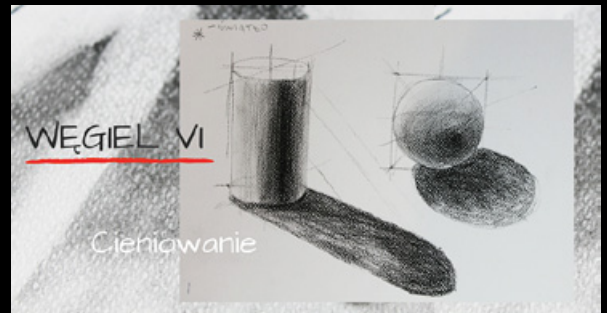
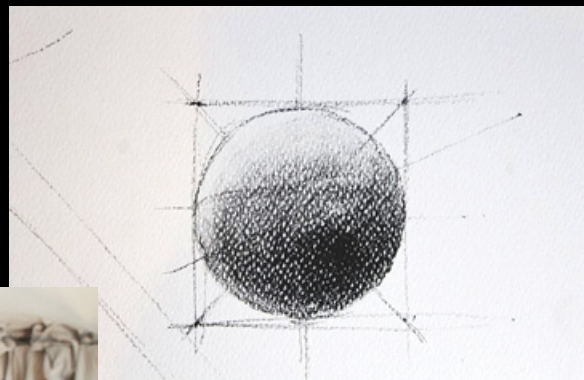

Węgiel – nauka rysunku od podstaw na fiorelki.pl  
Charcoal – find tutorials at fiorelki.pl

## Węgiel naturalny

- pakowany po 5 szt.

## Natural charcoal

- box 5 pcs.



INDEKS INDEX	SYMBOL SYMBOL	ROZMIAR SIZE	EAN BARCODE
170-1888	C7345	Ø 10 ± 1 mm	6 901893 800149

## Węgiel w drewnie

- pakowany po 12 szt.

## Charcoal in wood

- box 12 pcs.

węgiel w drewnie należy temperować nożykiem lub temperówką ślimakową;  
tradycyjna temperówka może kruszyć miękki grafit węglowy  
charcoal in wood is to be sharpened with knife or with steel alloy cutter;  
traditional blade sharpener may shatter soft charcoal lead

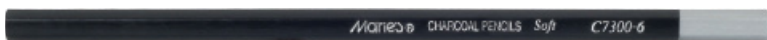

INDEKS INDEX	SYMBOL SYMBOL	KOLOR COLOR	TWARDOŚĆ HARDNESS	EAN BARCODE
170-1893	C7300-6	● czarny black	miękki soft	6 901893 800811
170-1894	C7304H	● szary grey	średnio twardy medium hard	6 901893 873044





### Zestaw G873256

- ołówek Kubuś i 6 wkładów

### Set G873256

- mechanical pencil and 6 leads

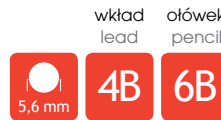

wkład lead ołówek pencil

INDEKS INDEX

EAN BARCODE

170-1906



### Gumka chlebowa C6142

- profesjonalna gumka przeznaczona do usuwania i rozjaśniania pastelów suchych oraz węgla, sepii, miękkich ołówków (4B-8B) i innych miękkich technik suchych
- wycieranie (rozjaśnianie) odbywa się poprzez przykładanie i odrywanie gumki w miejscu retuszu
- po zabrudzeniu gumki należy ją rozgnieść i ponownie uformować
- wymiary: 44x35x10 mm
- pakowana po 24 szt.

### Kneadable artistic eraser C6142

- professional eraser for removing and brightening dry pastels, charcoal, sepia, soft pencils (4B-8B) and other soft techniques
- erase (brighten) by applying and peeling off eraser in retouched area
- when dirty, mash and re-mold eraser
- size: 44x35x10 mm
- box 24 pcs.



INDEKS INDEX

EAN BARCODE

170-1883



## Papier Prisma

- faktura chmurkowa
- techniki: wydruki artystyczne, sitodruk, druk wklęsły
- przeznaczenie: ulotki, materiały reklamowe, kalendarze, plakaty, katalogi, karty okolicznościowe, wizytówki, passe-partout, oprawy książek itp.
- opakowanie zawiera 50 arkuszy

## Prisma textured paper

- textured paper
- for artistic printing, screen printing, intaglio printing
- for leaflets, advertising materials, calendars, posters, catalogs, greeting cards, business cards, passe-partout, book covers, etc.
- packaging: 50 sheets

EAN BARCODE



220  
g/m<sup>2</sup>  
gsm

A4



## Bloki malarskie Art Deco akwarela

- papier dwustronnie fakturowany
- przeznaczone do akwareli i akwaforty

## Art Deco water color paper

- two-side textured paper
- for water color and etching

INDEKS INDEX	FORMAT FORMAT	ZAWIERA SHEETS
150-1443	A5 105x210 mm	10 ark. sheets
150-1210	A4 210x297 mm	10 ark. sheets
150-1206	A3+ 300x420 mm	10 ark. sheets
150-1325	A2 420x594 mm	10 ark. sheets

EAN BARCODE



300  
g/m<sup>2</sup>  
gsm



# nowości

## novelties



**Linia COLORtouch:** Energetyczne kolory, charakterystyczny czarny znak na obudowie – seria COLORtouch daje gwarancję ciekawego i funkcjonalnego urządzenia niezależnie od tego, gdzie jest teraz Twoje biuro.



**ColorTouch! collection:** vivid colors & distinctive black element on the casing – the COLORtouch series guarantees interesting and functional devices no matter where your office currently is.

### Dziurkacz COLORtouch TYP6602

- metalowa konstrukcja, obudowa z tworzywa ABS
- antypoślizgowe ramię z metalowym wzmocnieniem
- pojemnik na odpady z tworzywa sztucznego nierysującego podłoża
- listwa formatowa
- wskaźnik środka strony



### Punch COLORtouch TYP6602

- metal construction, lever made of ABS material
- non-slip arm with metal reinforcement
- waste container made of non-abrasive material
- page center indicator
- guide bar



INDEKS INDEX	KOLOR COLOR	EAN BARCODE
110-1687	niebieski blue	5 903364 219123
110-1688	różowy pink	5 903364 219147
110-1689	żółty yellow	5 903364 219161

### Zszywacze COLORtouch

- metalowa konstrukcja, obudowa z tworzywa
- antypoślizgowe ramię
- wskaźnik ilości zszywek



#### TYST6101B



INDEKS INDEX	KOLOR COLOR	EAN BARCODE
110-1681	niebieski blue	5 903364 219000
110-1682	różowy pink	5 903364 219024
110-1683	żółty yellow	5 903364 219048

### Staplers COLORtouch

- metal construction, casing made of durable material
- non-slip arm
- staples residue indicator



#### TYST6102B



INDEKS INDEX	KOLOR COLOR	EAN BARCODE
110-1684	niebieski blue	5 903364 219062
110-1685	różowy pink	5 903364 219086
110-1686	żółty yellow	5 903364 219109

**Linia Ha!**: Oplywowe kształty, wyraziste kolory, matowe pokrycie soft – seria Ha! sprawdzi się wszędzie tam, gdzie potrzebny jest wyrazisty akcent.

**Ha! collection**: smooth shape, expressive colors, matte soft cover – the Ha! series is perfect whenever a distinctive accent is needed.

**EAGLE**

**Ha!**

## Dziurkacz Ha! TYP862

- metalowa konstrukcja, obudowa z tworzywa
- pojemnik na odpady z tworzywa sztucznego nierysującego podłoża
- ramię antypoślizgowe
- listwa formatowa
- wskaźnik środka strony

INDEKS INDEX	KOLOR COLOR	EAN BARCODE
110-1693	niebieski blue	5 903364 219246
110-1694	różowy pink	5 903364 219260
110-1695	żółty yellow	5 903364 219284

## Punch Ha! TYP862

- metal construction, lever made of durable material
- waste container made of non-abrasive material
- non-slip arm
- page center indicator
- guide bar

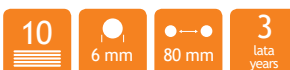

## Zszywacz Ha! TYS1208

- stojący
- metalowa konstrukcja, obudowa z tworzywa
- antypoślizgowe ramię
- mechanizm umożliwiający łatwe ładowanie zszywek
- wskaźnik ilości zszywek

INDEKS INDEX	KOLOR COLOR	EAN BARCODE
110-1690	niebieski blue	5 903364 219185
110-1691	różowy pink	5 903364 219208
110-1692	żółty yellow	5 903364 219222

## Stapler Ha! TYS1208

- stand-up
- metal construction, casing made of durable material
- non-slip arm
- easy loading mechanism
- staples residue indicator



## Pojemnik na długopisy Ha! TYP691

- wykonany z tworzywa
- rozmiar: 80 x 80 x 98 mm

INDEKS INDEX	KOLOR COLOR	EAN BARCODE
120-1930	niebieski blue	5 903364 219369
120-1931	różowy pink	5 903364 219383
120-1932	żółty yellow	5 903364 219406

## Pen holder Ha! TYP691

- made of durable material
- size: 80x80x98 mm



## Uchwyt do taśmy Ha! TYT581

- niewielki, wygodny uchwyt z obcinaczem
- maks. rozmiar taśmy: 22 x 50

INDEKS INDEX	KOLOR COLOR	EAN BARCODE
130-1899	niebieski blue	5 903364 219307
130-1900	różowy pink	5 903364 219321
130-1901	żółty yellow	5 903364 219345

## Tape dispenser Ha! TYT581

- small, comfortable tape dispenser with a cutter
- max tape size: 22 x 50



**EAGLE****SAVE FORCE****Zszywacz Save Force TYST030**

- stabilna metalowa konstrukcja
- elementy wykończeniowe z trwałych tworzyw sztucznych
- wskaźnik ilości zszywek pozostałych w magazynku
- redukcja siły nacisku do 50%
- pojemnik na zapasowe zszywki
- wbudowany wyciągacz zszywek



INDEKS INDEX

110-1696

110-1698

110-1697

KOLOR COLOR

○ biały white

● niebieski blue

● różowy pink

EAN BARCODE

**EAGLE****Dziurkacz P7123**

- dziurkacz metalowy o dużej wytrzymałości
- pojemnik na odpady z tworzywa sztucznego nierysującego podłoża
- podwójny wskaźnik środka strony
- listwa formatowa
- blokada do łatwego przechowywania

**Punch P7123**

- heavy duty metal punch
- waste container made of non-abrasive material
- double page center indicator
- guide bar
- lever lock for easy storage

INDEKS INDEX

110-1700

EAN BARCODE

**EAGLE****Zszywacz automatyczny EG-1610USB**

- solidny mechanizm zapewnia doskonałą wydajność i cichą pracę
- zasilanie sieciowe (USB) lub bateryjne (nie dołączono)
- kabel USB w zestawie



INDEKS INDEX

110-1701

KOLOR COLOR

● czarny black

EAN BARCODE

**Automatic stapler EG-1610USB**

- durable motorized mechanism provides excellent performance and quiet operation
- for AA batteries (not included) and USB cable
- USB cable included

## Zestaw J5072BC

### Dziurkacz P6068B

- dziurkacz metalowy
- pojemnik na odpady z tworzywa sztucznego nierysującego podłoża
- listwa formatowa
- wskaźnik środka strony

### Zszywacz S5072

- wskaźnik ilości zszywek
- + zszywki 26/6 – 200 szt.



## Set J5072BC

### Punch P6068B

- metal construction
- waste container made of non-abrasive material
- guide bar
- page center indicator

### Stapler S5072

- wskaźnik ilości zszywek
- + staples 26/6 – 200 pcs.



INDEKS INDEX

110-1699

EAN BARCODE



## Pojemnik na kable

- pozwala zachować porządek estetyczny i funkcjonalny; ukrywa zbyt długie kable sprzętów RTV, komputerów, zasilaczy, ładowarek i innych, a jednocześnie gromadzi w jednym miejscu wszystkie przydatne wtyczki
- chroni kable przed kurzem i wilgocią
- stanowi zabezpieczenie przed dziećmi i zwierzętami
- minimalistyczny wzór

## Cable organizer

- enables to keep aesthetic and functional order: it hides long cables of RTV equipment, computers, power supplies and chargers, and keeps all plugs in one spot
- protects cables from dust and moisture
- provides protection against children and animals

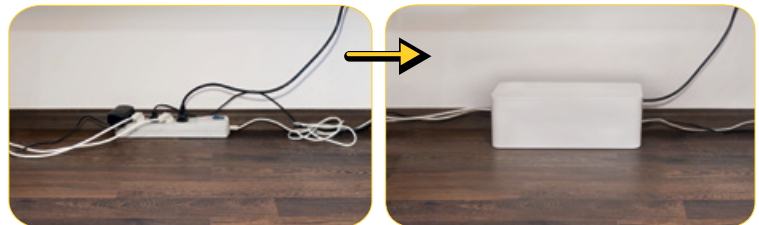

## YL-PK320

- 320x135x125 mm

INDEKS INDEX KOLOR COLOR

120-1933 ○ biały white

120-1934 ● czarny black

EAN BARCODE



## YL-PK405

- 405x155x135 mm

INDEKS INDEX KOLOR COLOR

120-1935 ○ biały white

120-1936 ● czarny black

EAN BARCODE





## Taśma dwustronna z uchwytem



- z uchwytem ułatwiającym odrywanie taśmy
- bezwonna
- pokryta emulsyjnym klejem akrylowym
- nie zawiera rozpuszczalników organicznych
- stabilna substancja klejąca odporna na działanie światła
- wzmocniona powłoka taśmy odporna na starzenie
- zastosowanie w szerokim zakresie temperatur

## Adhesive tape double-sided with dispenser

- dispenser enables tearing the tape off
- odorless
- covered with acrylic glue
- organic solvent-free
- stable sticking substance resistant to light
- strengthened tape surface resistant to aging
- ready to use in wide range of temperature

INDEKS INDEX	ROZMIAR SIZE	EAN BARCODE
130-1903	18 mm x 8,5 m	5 903364 277987

## Datowniki 4510



- samotuszujące
- obudowa z tworzywa sztucznego pokryta materiałem antypoślizgowym
- wysokość czcionki 4 mm
- wersja literowo-cyfrowa posiada polskie nazwy miesięcy

## Daters 4510

- self-inking
- plastic cover coated with non-slip material
- font size 4 mm
- literal & numerical with Polish month names

	INDEKS INDEX	SYMBOL SYMBOL	TYP TYPE	EAN BARCODE
25 11 2020	140-1064	GR-4510C	cyfrowy numerical	5 903364 238650
25 LIS 2020	140-1065	GR-4510L	literowo-cyfrowy literal & numerical	5 903364 238674

## Linijki drewniane

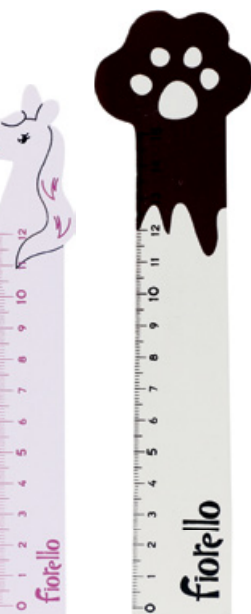

- linijki drewniane w zabawnych kształtach
- skala w cm wraz z oznaczeniami pomocniczymi mm
- mogą służyć też jako szablon do odrysowania kształtu
- grubość 3 mm

## Wooden rulers

- funny shapes
- cm scale with additional mm marks
- can be used as template to draw the shapes
- 3 mm thick

INDEKS INDEX	SYMBOL SYMBOL	RODZAJ TYPE	POMIAR MEASUREMENT	EAN BARCODE
130-1904	GR-F67JR	jednorozec unicorn	12 cm	5 903364 277949
130-1905	GR-F77LP	łapa paw	15 cm	5 903364 277963
130-1906	GR-F37MW	miś wieszak bear hanger	15 cm	5 903364 277901
130-1907	GR-F47MM	miś miarka bear scale	15 cm	5 903364 277925

## Cyrkiel GR-C106

- metalowa konstrukcja
- w zestawie wymienny grafit
- długość cyrkiela 125 mm
- pastelowe kolory

## Compass GR-C106

- metal construction
- spare graphite included
- compass length 125 mm
- pastel colors

Grand®



INDEKS INDEX

EAN BARCODE

130-1902



## Spinacze groszki

- metalowe, lakierowane

### Paper clips green pea

- metal, varnished



INDEKS  
INDEX

ROZMIAR  
SIZE

OPAK.  
BOX

OPAK.  
BOX

EAN  
BARCODE

110-1702

30 mm

20 szt. pcs.

T4



## Spinacze marchewka

- metalowe, lakierowane

### Paper clips carrot

- metal, varnished



INDEKS  
INDEX

ROZMIAR  
SIZE

OPAK.  
BOX

OPAK.  
BOX

EAN  
BARCODE

110-1703

37 mm

20 szt. pcs.

T4



## Folia do laminacji

- do zastosowania w technice laminacji
- do wszelkiego typu dokumentów oraz zdjęć
- laminowanie chroni dokumenty przed zabrudzeniem, uszkodzeniem oraz zalaniem
- błyszcząca
- 100 szt.

## Laminating pouch

- for hot lamination technique
- for all types of documents and photos
- laminating protects documents from dirt, moisture or other damages
- glossy
- 100 pouches

Grand®



80  
mic

100

INDEKS INDEX

DO FORMATU FOR SIZE

EAN BARCODE

160-2192

A4 (216x303 mm)



160-2276

A3 (303x426 mm)



## Notesy samoprzylepne czarne

- po odklejeniu nie pozostawiają śladów
- wszechstronne zastosowanie w domu, biurze i w szkole
- doskonałe rozwiązanie do oznaczania, zapisywania i przekazywania informacji
- notes 100 karteczek  
lub zestaw 2 notesy, 2 długopisy



INDEKS INDEX	SYMBOL SYMBOL	ROZMIAR SIZE	ZESTAW SET
150-1452	654 BL	75x75 mm	notes sticky note 2 notesy, 2 długopisy srebrne
150-1453	654 BL-2P	75x75 mm	2 sticky notes, 2 silver gel pens

EAN  
BARCODE



## Sticky notes black

- leave no stains after removing
- multi-purpose at home, school and office
- perfect solution for labeling, taking notes and delivering messages
- sticky notes 100 sheets or set: 2 sticky notes, 2 gel pens

## Ołówek z diamentcikami

- wykonany z drewna zabarwionego na czarny kolor
- indywidualny kod kreskowy

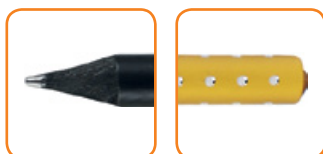

## Pencil with diamonds

- made of black dyed wood
- individual barcode



INDEKS INDEX	OPAK. PKG.
160-2274	48 szt. pcs.

EAN BARCODE



## Ołówek tęczy

- wykonany z drewna zabarwionego na czarny kolor, foliowany kolorowo
- indywidualny kod kreskowy



## Rainbow pencil

- made of black dyed wood
- covered with color foil
- individual barcode



INDEKS INDEX	OPAK. PKG.
160-2275	48 szt. pcs.

EAN BARCODE



## Przekładki do segregatora

- kartonowe
- możliwość wpięcia pionowo lub poziomo
- rozmiar 240x105 mm
- 4 kolory pastelowe lub 5 kolorów intensywnych
- pakiet 100 szt.

100

INDEKS INDEX KOLOR COLOR

120-1942 pastelowe pastel

120-1943 intensywne intense

EAN BARCODE



## Binder dividers

- cardboard
- use in vertical or horizontal position
- size 240x105 mm
- 5 intense or 4 pastel colors
- set 100 pcs.

Grand®



## Długopis GR-F5518 4 kolory

- automatyczny
- 4 wkłady
- ergonomiczna obudowa z uchwytem antypoślizgowym

## Ball pen GR-F5518 4 colors

- retractable
- 4 refills
- ergonomic cover with non-slip grip

fiorello®



INDEKS INDEX OPAK. PKG.

160-2267 24 szt. pcs.

EAN BARCODE



## Długopis 4 kolory

- automatyczny
- 4 wkłady
- ergonomiczna obudowa z uchwytem antypoślizgowym
- indywidualny kod kreskowy w formie naklejki usuwalnej bez śladu

## Ball pen 4 colors

- retractable
- 4 colors of refills
- ergonomic cover with non-slip grip
- removable sticker with individual barcode

CARIOCA®

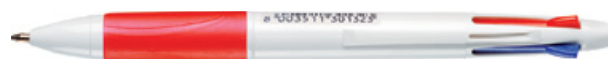

INDEKS INDEX OPAK. PKG.

160-2266 24 szt. pcs.

EAN BARCODE





### Długopis GR-2033

- z wymiennym wkładem
- ergonomiczna obudowa
- idealny pod nadruk reklamowy – nie posiada żadnych oznaczeń



### Ball pen GR-2033

- with replaceable refill
- ergonomic cover
- for advertising imprint – no marks

0,7  
mm

700 m

**długopis pod nadruk bez oznaczeń**  
for advertising no marks

INDEKS INDEX	KOLOR COLOR	OPAK. PKG.	EAN BARCODE
160-2263	● czarny black	24 szt. pcs.	 5 903364 241988
160-2264	● niebieski blue	24 szt. pcs.	 5 903364 242008



### Długopis GR-2120

- automatyczny z wymiennym wkładem
- ergonomiczna obudowa z elementami antypoślizgowymi

### Ball pen GR-2120

- retractable with replaceable refill
- ergonomic cover with non-slip elements

0,7  
mm

650 m



INDEKS INDEX	OPAK. PKG.	EAN BARCODE
160-2269	24 szt. pcs.	 5 903364 281038



### Długopis GR-2256

- automatyczny z wymiennym wkładem
- ergonomiczna obudowa z elementami antypoślizgowymi

### Ball pen GR-2256

- retractable with replaceable refill
- ergonomic cover with non-slip elements

0,7  
mm

650 m



INDEKS INDEX	OPAK. PKG.	EAN BARCODE
160-2270	24 szt. pcs.	 5 903364 281052

## Marker do płyt CD/DVD CM-051

- przeznaczony do gładkich powierzchni
- wodoodporny, niezmywalny
- dwustronna końcówka



## CD/DVD marker CM-051

- for smooth surfaces
- waterproof, indelible
- two-sided

INDEKS INDEX KOLOR COLOR OPAK. PKG. EAN BARCODE

160-1878	● czarny	black	24 szt. pcs.	6 930126 705104
160-2272	● czerwony	red	24 szt. pcs.	5 903364 280338
160-2273	● niebieski	blue	24 szt. pcs.	5 903364 280314

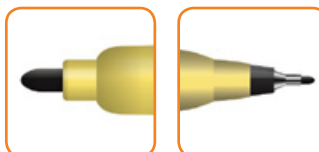

## Zakreślacz w sztyfcie CANDY HLC

- grafit żelowy o grubości ok. 10 mm
- wykręcany sztyft
- łatwa aplikacja na różnych typach atramentu
- nie rozmazuje zakreślanego tekstu odręcznego ani wydruków
- nie przesiąka przez papier
- nie powoduje marszczenia papieru
- **pozostawiony bez zatyczki nie wysycha**
- jednolity, pastelowy kolor
- możliwe ostrzenie nożykiem
- niezwykle gładkie i ciche zakreślanie
- może być używany jako pastelowa kredka
- niewidoczny na fotokopiach
- opakowanie: 12 szt. lub blister 4 kol.

## Dry Highlighter CANDY HLC

- lead ca. 10mm diameter
- twist-up
- no blurring of highlighted text
- easy use on different ink types
- no sinking through any paper
- no wrinkles on paper
- **no drying out when left open**
- consistent pastel color
- possible sharpening with knife
- smooth and quiet highlighting
- can be also used as pastel color crayon
- invisible on photocopies
- packaging: 12 pcs. or blister card 4 col.

AMOS®

INDEKS INDEX KOLOR COLOR EAN BARCODE

160-2257	● miętowy	emerald green	8 802946 511990
160-2258	● turkusowy	aqua blue	8 802946 512010
160-2259	● lawendowy	lavender violet	8 802946 512027
160-2260	● róż pudrowy	milky pink	8 802946 512003
160-2261	4 kol.	col.	8 802946 512034



## Zakreślacz w sztyfcie HLD12

- zestaw 4 kolory – blister



## Dry highlighter HLD12

- set 4 colors – blister card

INDEKS INDEX KOLOR COLOR OPAK. PKG. EAN BARCODE

160-2265	4 kol.	col.	blister b/c	8 802946 508075
----------	--------	------	-------------	-----------------



# CARIOCA<sup>®</sup> METALLIC



METALICZNE – IDEALNE DO CIEMNYCH POWIERZCHNI

METALLIC – PERFECT FOR DARK SURFACES

## CARIOCA<sup>®</sup> METALLIC



### Kredki ołówkowe metaliczne

- idealne do ciemnych powierzchni
- ostrzone
- łatwe do ostrzenia
- mocny grafit
- sześciokątne

### Metallic color pencils

- perfect for dark surfaces
- sharpened
- easy to sharpen
- strong lead
- hexagonal cross-section



INDEKS INDEX ZESTAW SET EAN BARCODE

170-2567

12 kol. col.



## CARIOCA<sup>®</sup> METALLIC



### Kredki świecowe metaliczne

- idealne do ciemnych powierzchni
- kryjące – kolejne warstwy dokładnie pokrywają poprzednie

### Metallic crayons

- perfect for dark surfaces
- high covering – top layer covers thoroughly the bottom one



INDEKS INDEX ZESTAW SET EAN BARCODE

170-2568

8 kol. col.



## Pisaki metaliczne

- idealne do ciemnych powierzchni
- trwałe kolory na porowatych powierzchniach, usuwalne z gładkich powierzchni
- można utrwalić emalią akrylową, aby uzyskać efekt na bardzo długi czas
- tusz łatwy do usunięcia ze skóry lub tkaniny za pomocą samej wody
- poliesterowa końcówka
- końcówka wyposażona w blokadę – nie ma możliwości wciśnięcia jej do środka
- bezpieczna wentylowana zatyczka umożliwia oddychanie w przypadku połknięcia
- obudowa z tworzywa sztucznego pochodzącego w 53% z recyklingu



INDEKS INDEX ZESTAW SET

170-2569 8 kol. col.

EAN BARCODE



CE 0,5-1 mm

## Metallic fibre pens

- perfect for dark surfaces
- permanent colors on porous surfaces and removable from smooth surfaces
- fix with acrylic enamel for a long-lasting effect
- easy to remove from skin or fabric with water only
- felt tip pens
- safe ventilated plug enables breathing if swallowed
- point-blocked: not possible to push it inside
- 53% recycled plastic body



## Farby w sztyfcie Temperello metaliczne

- idealne do ciemnych powierzchni
- miękki sztyft pozwala na łatwe i przyjemne malowanie
- nie wymagają używania pędzla i wody, ale można ich użyć, by uzyskać efekt akwareli
- wyraziste, łatwo mieszalne kolory
- łatwowymyalne
- mocno kryjące
- szybkoschnące
- nie marszczą papieru
- nie zawierają rozpuszczalników

INDEKS INDEX ZESTAW SET

170-2570 6 kol. col.

EAN BARCODE



## Poster paint stick Temperello metallic

- perfect for dark surfaces
- soft stick, easy and comfortable painting
- it can be used with no brush or water, but you can use it to create watercolor effect
- vivid, blendable colors
- easy to clean
- high covering
- quick-drying
- no paper wrinkling
- solvent free



CARIOCA  
METALLIC

CARIOCA  
METALLIC





## Markery akrylowe GR-1106

- szybkoschnący tusz na bazie wody
- kryjące, intensywne kolory
- przeznaczone do wielu powierzchni, jak karton, drewno, ceramika, tynk, tkanina, skóra...
- można ozdabiać nimi torebki, buty, pokrowce na telefon, kamienie i inne
- dla artystów i amatorów



## Acrylic markers GR-1106

- water-based, quick-drying
- bright, opaque colors
- for many surfaces, eg. for cardboard, wood, ceramic, plaster, fabric, leather...
- to decorate handbags, shoes, mobile phone shells, stones and other materials
- for artists and amateurs



INDEKS INDEX ZESTAW SET  
160-2262 12 kol. col.

EAN BARCODE



## Pisaki metrowe

- jeden metr pisaków
- filcowa końcówka
- końcówka wyposażona w blokadę – nie ma możliwości wciśnięcia jej do środka
- wysokiej jakości, wyrazisty tusz na bazie wody
- tusz łatwy do usunięcia ze skóry lub tkaniny za pomocą samej wody
- bezpieczna wentylowana zatyczka umożliwia oddychanie w przypadku połknięcia
- zawiera kartonowy pojemnik na długopisy do pokolorowania (należy wyciąć z tyłu opakowania)



## Coloring meter felt tip pens

- a meter of felt tip pens
- point-blocked: not possible to push it inside
- high quality vivid ink, water-based
- superwashable ink – easy to remove from skin or fabric with water only
- safe ventilated plug enables breathing if swallowed
- contains a pen holder to cut and color in the back part of the box



INDEKS INDEX ZESTAW SET  
160-2278 100 szt. pcs.

EAN BARCODE



## Pisaki Magic Laser

- filcowa końcówka
- końcówka wyposażona w blokadę
  - nie ma możliwości wciśnięcia jej do środka
- wysokiej jakości, wyrazisty tusz na bazie wody
- bezpieczna wentylowana zatyczka umożliwia oddychanie w przypadku połknięcia
- w zestawie pisaki kolorowe oraz wymazywacz
- wymazywacz służy do poprawiania błędów lub pisania białym kolorem na pokolorowanej powierzchni



INDEKS INDEX ZESTAW SET

160-2277 10 szt. pcs.

EAN BARCODE



## Magic Laser felt tip pens

- felt tip
- point-blocked – not possible to push it inside
- high quality vivid ink, water-based
- safe ventilated plug enables breathing if swallowed
- set of color pens with eraser
- eraser for correcting errors or writing with white color on colored area



## Pisaki Magic – zestaw

- filcowa końcówka
- 9 pisaków Erasable + 1 pisak wymazywający
- 5 pisaków ColorUp + 5 pisaków fluorescencyjnych, zmieniających kolor pozostałych
- 9 pisaków ColorChange + 1 pisak zmieniający kolor
- bezpieczna wentylowana zatyczka umożliwia oddychanie w przypadku połknięcia
- końcówka wyposażona w blokadę
  - nie ma możliwości wciśnięcia jej do środka



INDEKS INDEX ZESTAW SET

160-2271 30 szt. pcs.

EAN BARCODE



## Magic felt tip pens set

- felt tip pens
- 9 erasable pens + 1 Magic erasing pen
- 5 ColorUp pens + 5 fluorescent pens which change the color of the others
- 9 ColorChange pens + 1 Magic changing pen
- safe ventilated plug enables breathing if swallowed
- point-blocked: not possible to push it inside





## Kredki BABY

- super miękkie pastele olejne
- stworzone z myślą o najmłodszych, przeznaczone dla dzieci od 2 lat
- ekstra grube
- pomocne w nauce chwytania
- stymulują zdolności motoryczne
- jasne, żywe kolory
- zmywalne
- średnica kredki 15 mm



## BABY Crayons

- super soft oil pastels
- developed for children from 2 years old
- extra large body helps to develop correct grip
- stimulate motor skills
- bright colors
- washable
- crayon diameter 15 mm

**dla dzieci od 2. roku życia**  
for children from 2 years old

INDEKS INDEX ZESTAW SET EAN BARCODE

170-2573

8 kol. col.



## Farby tempery do malowania palcami

- idealne dla najmłodszych, którzy jeszcze nie potrafią używać pędzla
- można je dowolnie mieszać, co pozwala uzyskać nowe kolory i odcienie
- łatwo zmywalne z rąk i tkanin
- bezpieczne, bezapachowe
- gotowe do użycia bez dodawania wody



## Finger paints

- perfect for toddlers who are not yet able to use brush
- can be mixed to obtain new colors and shades
- easy washable from hands and fabric
- safe, odorless
- ready to use with no addition of water

**dla dzieci od 2. roku życia**  
for children from 2 years old

INDEKS INDEX ZESTAW SET EAN BARCODE

170-2574

8 kol. x 50 ml  
8 col. x 50 ml



## Pędzel BABY

- łatwy do trzymania
- idealny do dużych powierzchni
- syntetyczne włosie



## BABY brush

- easy to handle
- perfect for large surfaces
- synthetic bristle

**dla dzieci od 2. roku życia**  
for children from 2 years old

INDEKS INDEX

EAN BARCODE



170-2592



## Farby tempery

- wodorozcieńczalne tempery
- idealne do nauki i do prac grupowych
- do malowania na wszystkich porowatych powierzchniach: papierze, kartonie, drewnie, polistyrenie itp.
- łatwo zmywalne, bezzapachowe
- można je dowolnie mieszać, co pozwala uzyskać nowe kolory i odcienie
- możliwość warstwowego malowania i korekt
- gotowe do użycia bez dodawania wody
- przechowywać w temperaturze 10–40°C
- pojemność 500 ml

## Tempera paints

- water-soluble tempera paints
- perfect for beginners and collective works
- for rigid surfaces: paper, cardboard, wood, polystyrene
- easily washable, odorless
- can be mixed to obtain new colors and shades
- possibility of stratified painting and corrections
- ready to use with no addition of water
- store in 10–40°C
- capacity 500 ml

**CARIOCA**



## neonowe neon



neon różowy  
neon pink

170-2590  
8 003511 270377



neon zielony  
neon green

170-2591  
8 003511 270384

**! nowe kolory**  
new colors

## pastelowe pastel



pastel niebieski  
pastel blue

170-2587  
8 003511 270445



pastel różowy  
pastel pink

170-2588  
8 003511 270421



pastel zielony  
pastel green

170-2589  
8 003511 270438



## Masa do modelowania

- samoutwardzalna masa modelarska
- gotowa do użycia, miękka, przyjemna w dotyku
- nieprzezroczysta
- łatwa do wyrabiania, wygładzania oraz do nałożenia na dowolne podłoże (porowate powierzchnie najpierw zwilżyć wodą)
- nie wymaga wypalania, wysycha i utwardza się pod wpływem powietrza
- gotowe prace można udekorować farbami, np. temperą, lub pisakami
- idealna w domu i szkole, dla hobbystów oraz artystów, doskonała na warsztaty artystyczne
- pokrycie gotowej pracy lakierem ochronnym nada jej połysk i trwałość
- aby masa nie wysychała, należy przechowywać ją w szczelnym pojemniku
- waga 500 g

## Modelling material

- self-hardening
- ready to use, soft, pleasant touch
- opaque
- easy to knead and to smoothen
- can be applied to any surface (porous surfaces: moisten with water first)
- air-dry: no baking required
- finished works can be decorated with paints, e.g. tempera, or felt-tip pens
- perfect for home and school use, for hobbyists and artists, for art workshops
- covering finished work with protective varnish gives it gloss and durability
- store in airtight container
- weight 500 g

**CARIOCA**  
**DÉCO**



CE

INDEKS INDEX

170-2572

170-2571

ZESTAW SET

○ biała white

● terakota terracotta

EAN BARCODE

8 003511 319960

8 003511 309961



**GLASS DECO****AMOS**

## Farby witrażowe Glass Deco

- wysokiej jakości farby witrażowe przeznaczone do samodzielnego wykonania witraży oraz dekoracji szkła, porcelany, lusterek, płytek ceramicznych i tworzyw sztucznych
- wyraziste kolory, łatwa aplikacja farb
- odklejalne – gotowy, wyschnięty wzór można przenosić z folii na inne powierzchnie
- możliwe jest łączenie farb witrażowych z innymi technikami: klejem z brokatem, Ciasto-Plasto

## Glass Deco paints

- high quality glass deco paints for creating individual stained glass and decorating glass, porcelain, mirrors, tiles and other surfaces
- vivid colors, easy application
- removable – dry pattern can be moved from foil to other surface
- possible to use with other techniques: Glitter Glue, i-Clay



### nowe zestawy

#### ZAWIERA:

- 12 gotowych witraży-breloków do pomalowania
- 10 kol. farb
- pojemność: 10,5 ml

### new sets

#### SET CONTAINS:

- 12 ready-to-use suncatchers to paint
- 10 paint colors
- capacity: 10,5 ml



gwiazdozbiory  
constellations



zwierzęta  
animals



INDEKS INDEX	SYMBOL SYMBOL	ZESTAW SET	EAN BARCODE
170-2565	SD10P10-CL	gwiazdozbiory constellations	
170-2564	SD10P10-ZA	zwierzęta animals	

**fiorello****CE**

## Cekiny oczka fluo

- oczka z ruchomymi czarnymi źrenicami
- świecące w ciemności

## Wiggle eyes fluo

- eyes with black moving pupils
- glowing in the dark

**GR-KE50-12F**

- 12 mm, 50 szt.
- 12 mm, 50 pcs.

170-2560

**GR-KE15-20F**

- 20 mm, 15 szt.
- 20 mm, 15 pcs.

170-2563

**GR-KE10-25F**

- 25 mm, 10 szt.
- 25 mm, 10 pcs.

170-2562

**GR-KE04-40F**

- 40 mm, 4 szt.
- 40 mm, 4 pcs.

170-2561

## Perełki samoprzylepne

- idealne do zdobienia projektów scrapbookingowych, kartek okolicznościowych, pudełek oraz wszelkich prac kreatywnych
- można naklejać pojedyncze elementy lub całe paseczki

CE

## Pearls adhesive

- perfect for scrapbooking projects, greeting cards, decorating boxes and all types of creative work
- possible to use whole strips or single elements only

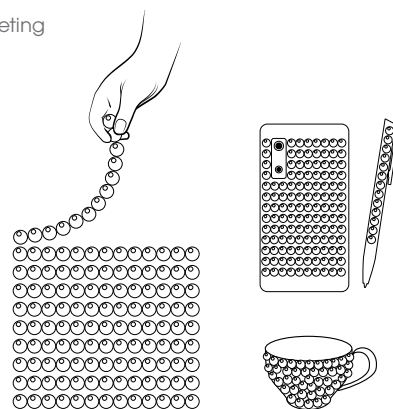

GR-PS162-3

170-2575

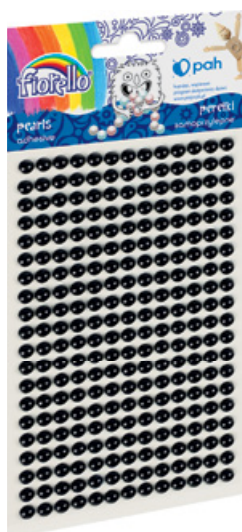

GR-PS162-10

170-2576

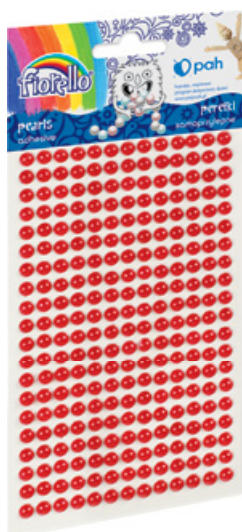

GR-PS162-4

170-2577

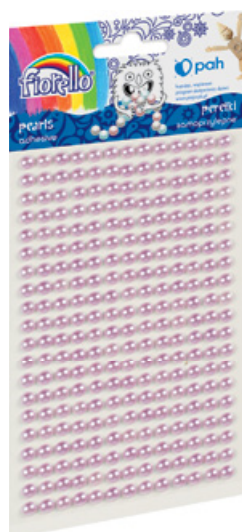

GR-PS162-7

170-2578

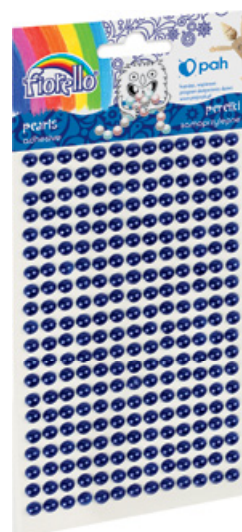

GR-S162-6

170-2579

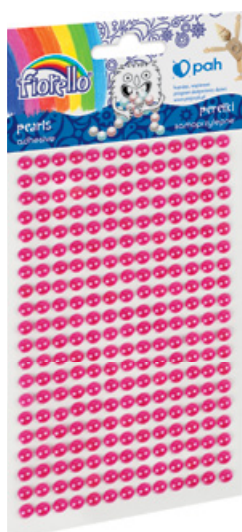

GR-PS162-8

170-2580



GR-PS162-9

170-2581

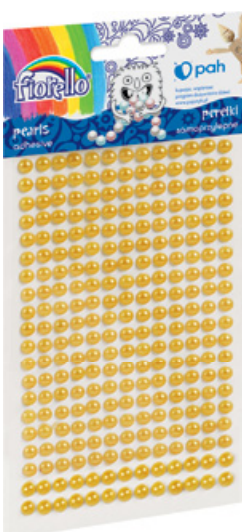

GR-PS162-5

170-2582

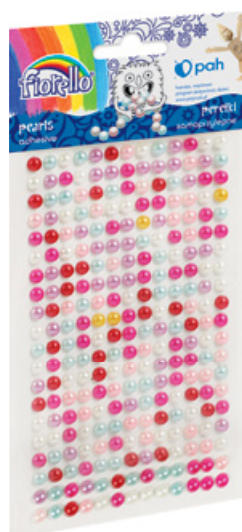

GR-PS162-1

170-2583

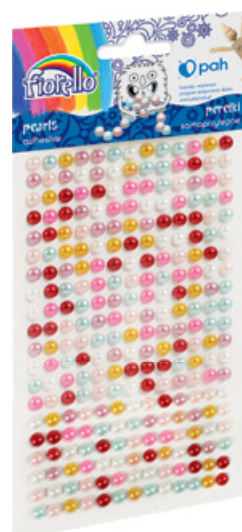

GR-PS162-2

170-2584



## Zestawy kreatywne

- do stworzenia własnych, wyjątkowych ozdób

## Creative sets

- create unique necklaces & bracelets

### Drewniane koraliki

- w zestawie: kuferek, drewniane koraliki, gumki
- przejrzysty kuferek pozwala łatwo posortować elementy, może być też torebką na inne drobiazgi

### Wooden beads

- set includes: jewelry chest, wooden beads, cords
- transparent chest enables easy separating of accessories, it can be handbag for other accessories as well



CE

INDEKS INDEX

170-2585

SYMBOL SYMBOL

GR-F8141

EAN BARCODE



### Bizuteria

- w zestawie: koraliki, alfabet: koraliki/charmsy, żyłki, gumka, akcesoria
- ponad 400 elementów

### Jewelry

- set includes: beads, alphabet beads/charms, cords, accessories
- 400+ elements



CE

INDEKS INDEX

170-2586

SYMBOL SYMBOL

GR-F8254

EAN BARCODE



## Plótno malarskie w bloku Canvas

- trzykrotnie gruntowane akrylem, gotowe do malowania plótno bawełniane
- przeznaczone do malowania farbami olejnymi, akrylowymi, plakatowymi oraz pastelami olejnymi i pisakami
- wygodny w użyciu jednostronnie klejony blok
- dla profesjonalistów i hobbystów
- 100% bawełna
- bezkwasowe
- gramatura ± 300 g/m<sup>2</sup>
- 10 arkuszy

## Canvas artist's pad

- cotton canvas, triple primed with acrylic paint
- for oil, acrylic, poster paint, for oil pastels & markers
- comfortable pad, short side glued
- for professionals and hobbyists
- 100% cotton
- acid-free
- weight ± 300 gsm
- 10 sheets



INDEKS INDEX	SYMBOL SYMBOL	ROZMIAR SIZE	EAN BARCODE
150-1435	GR-F0912	227x300 mm	5 903364 238360
150-1444	GR-F1216	305x406mm	5 903364 238421
150-1445	GR-F1620	406x508 mm	5 903364 238438
150-1446	GR-F1824	457x610 mm	5 903364 238445



akryl i olej  
acrylic & oil



farba plakatowa  
poster paint



pastele olejne  
oil pastel



pisaki  
markers

## Farby akrylowe

- dobrze i szybko schną, nie pękają
- doskonale przepuszczają powietrze
- odporne na wilgoć
- odporne na blaknięcie – kolory są intensywne i trwałe
- przeznaczone do malowania, pisania na papierze, drewnie, materiałach, cementcie, bambusie
- po zakończonej pracy pędzle należy umyć lub zamoczyć w wodzie
- pakowane w trwałe, aluminiowe tubki, chroniące przed wysychaniem i zapobiegające ulatnianiu się zapachu farb

## Acrylic colors

- fast drying, no cracking
- excellent air circulation
- resistant to humidity
- fade-resistant: colors are durable and vivid
- for painting and writing on paper, wood, fabric, cement, bamboo
- brushes should be washed or soaked in water
- durable metal tubes prevent paints from drying



## Farby akrylowe 816B

- pojemność 120 ml

## Acrylic colors 816B

- capacity 120 ml

INDEKS INDEX	KOLOR COLOR	EAN BARCODE
170-2593	biały titanium white	6 901893 032984
170-2594	czarny black	6 901893 033318
170-2595	czerwony crimson red	6 901893 033073
170-2596	niebieski ultramarine blue	6 901893 033134
170-2597	zielony sap green	6 901893 033233
170-2598	żółty lemon yellow	6 901893 033011





INDEKS INDEX	STR. PAGE	INDEKS INDEX	STR. PAGE	INDEKS INDEX	STR. PAGE	INDEKS INDEX	STR. PAGE	INDEKS INDEX	STR. PAGE	INDEKS INDEX	STR. PAGE
110-1001	38	110-1143	24	110-1317	17	110-1525	11	110-1701	29	120-1192	48
110-1002	21	110-1144	24	110-1319	33	110-1588	35	110-1702	37	120-1193	48
110-1004	21	110-1147	24	110-1324	33	110-1591	8	110-1703	37	120-1194	48
110-1007	20	110-1148	24	110-1325	33	110-1592	8	120-1023	64	120-1195	48
110-1009	20	110-1149	24	110-1326	33	110-1593	8	120-1024	64	120-1196	48
110-1010	20	110-1150	24	110-1327	33	110-1594	8	120-1025	64	120-1197	48
110-1013	19	110-1155	24	110-1328	33	110-1595	8	120-1026	64	120-1198	48
110-1014	19	110-1156	24	110-1329	33	110-1596	8	120-1027	64	120-1199	48
110-1015	19	110-1157	24	110-1330	33	110-1598	12	120-1028	64	120-1200	48
110-1016	19	110-1158	24	110-1331	33	110-1599	12	120-1029	64	120-1201	48
110-1023	19	110-1161	26	110-1377	35	110-1632	29	120-1030	64	120-1202	48
110-1024	19	110-1162	26	110-1378	35	110-1633	37	120-1031	64	120-1203	48
110-1025	19	110-1163	26	110-1380	35	110-1634	37	120-1033	64	120-1204	48
110-1026	19	110-1164	26	110-1381	34	110-1636	38	120-1034	64	120-1205	48
110-1028	19	110-1166	26	110-1382	34	110-1637	36	120-1035	64	120-1206	48
110-1029	19	110-1167	26	110-1383	34	110-1638	39	120-1043	54	120-1207	42
110-1030	19	110-1168	26	110-1384	34	110-1640	29	120-1046	51	120-1208	48
110-1031	19	110-1169	26	110-1385	34	110-1641	29	120-1048	36	120-1209	48
110-1033	18	110-1186	26	110-1386	34	110-1643	9	120-1048	36	120-1210	48
110-1034	18	110-1188	26	110-1387	34	110-1645	30	120-1055	44	120-1211	48
110-1035	18	110-1189	28	110-1388	32	110-1646	9	120-1065	58	120-1212	51
110-1036	18	110-1195	24	110-1389	32	110-1647	9	120-1066	58	120-1219	49
110-1038	18	110-1197	24	110-1390	32	110-1651	20	120-1067	58	120-1220	49
110-1039	18	110-1198	24	110-1391	35	110-1655	35	120-1068	58	120-1221	49
110-1040	18	110-1199	24	110-1396	17	110-1656	38	120-1069	59	120-1225	45
110-1041	18	110-1221	29	110-1398	17	110-1657	35	120-1070	59	120-1226	45
110-1042	18	110-1223	25	110-1399	17	110-1658	34	120-1074	59	120-1228	45
110-1043	18	110-1224	25	110-1400	22	110-1660	37	120-1075	59	120-1239	46
110-1044	18	110-1225	25	110-1401	31	110-1661	34	120-1080	66	120-1240	46
110-1045	18	110-1226	25	110-1402	31	110-1662	32	120-1080	66	120-1241	46
110-1047	18	110-1242	25	110-1413	23	110-1663	32	120-1081	66	120-1242	46
110-1049	18	110-1244	25	110-1419	38	110-1664	32	120-1081	66	120-1243	46
110-1050	18	110-1248	25	110-1422	32	110-1665	36	120-1117	55	120-1251	42
110-1052	21	110-1249	25	110-1429	27	110-1670	39	120-1118	55	120-1252	42
110-1054	21	110-1250	25	110-1440	27	110-1671	39	120-1119	52	120-1253	42
110-1070	20	110-1253	30	110-1441	27	110-1672	39	120-1120	52	120-1254	42
110-1071	20	110-1254	30	110-1446	16	110-1675	13	120-1121	54	120-1255	42
110-1072	14	110-1255	30	110-1447	16	110-1676	13	120-1122	54	120-1332	56
110-1073	14	110-1256	30	110-1448	16	110-1677	13	120-1123	54	120-1333	56
110-1074	14	110-1258	30	110-1449	17	110-1678	13	120-1124	54	120-1334	53
110-1083	16	110-1260	30	110-1450	17	110-1679	13	120-1125	52	120-1335	53
110-1086	16	110-1265	27	110-1451	17	110-1681	7	120-1126	52	120-1351	100
110-1091	35	110-1267	27	110-1455	26	110-1682	7	120-1127	56	120-1417	100
110-1092	35	110-1270	28	110-1456	26	110-1683	7	120-1128	56	120-1418	130
110-1093	35	110-1272	28	110-1482	38	110-1684	7	120-1129	53	120-1419	130
110-1094	35	110-1284	15	110-1483	38	110-1685	7	120-1130	53	120-1420	137
110-1095	35	110-1285	15	110-1491	12	110-1686	7	120-1131	52	120-1424	132
110-1096	35	110-1286	15	110-1492	12	110-1687	7	120-1132	52	120-1425	134
110-1115	38	110-1287	15	110-1495	13	110-1688	7	120-1134	53	120-1432	133
110-1116	38	110-1289	15	110-1496	13	110-1689	7	120-1136	53	120-1433	51
110-1118	32	110-1291	15	110-1507	10	110-1690	6	120-1156	49	120-1434	51
110-1119	32	110-1292	15	110-1508	10	110-1691	6	120-1158	49	120-1441	42
110-1120	32	110-1293	15	110-1509	11	110-1692	6	120-1161	43	120-1442	42
110-1121	32	110-1295	15	110-1510	11	110-1693	6	120-1162	43	120-1443	42
110-1125	32	110-1297	15	110-1512	10	110-1694	6	120-1163	42	120-1446	42
110-1126	32	110-1304	25	110-1513	10	110-1695	6	120-1164	42	120-1447	42
110-1127	32	110-1306	25	110-1515	10	110-1696	13	120-1165	42	120-1448	42
110-1137	34	110-1307	25	110-1516	10	110-1697	13	120-1166	42	120-1451	136
110-1138	34	110-1311	15	110-1521	11	110-1698	13	120-1174	44	120-1452	136
110-1139	37	110-1313	17	110-1522	11	110-1699	23	120-1190	48	120-1456	135
110-1142	24	110-1314	17	110-1524	11	110-1700	22	120-1191	48	120-1457	137

INDEKS INDEX	STR. PAGE	INDEKS INDEX	STR. PAGE	INDEKS INDEX	STR. PAGE	INDEKS INDEX	STR. PAGE	INDEKS INDEX	STR. PAGE	INDEKS INDEX	STR. PAGE
120-1458	133	120-1817	48	120-1896	63	130-1184	83	130-1298	77	130-1611	80
120-1459	56	120-1818	48	120-1900	132	130-1185	83	130-1299	77	130-1613	98
120-1460	56	120-1819	48	120-1901	132	130-1188	89	130-1300	77	130-1614	98
120-1461	43	120-1820	48	120-1902	132	130-1189	90	130-1301	77	130-1632	93
120-1462	44	120-1821	48	120-1903	132	130-1190	90	130-1311	97	130-1640	108
120-1463	44	120-1822	48	120-1904	131	130-1191	89	130-1312	97	130-1649	100
120-1464	44	120-1823	48	120-1905	63	130-1192	89	130-1313	97	130-1652	104
120-1465	44	120-1824	48	120-1906	63	130-1193	76	130-1314	97	130-1653	104
120-1470	44	120-1825	48	120-1928	66	130-1196	76	130-1315	97	130-1654	105
120-1471	44	120-1826	48	120-1929	248	130-1198	89	130-1319	105	130-1655	105
120-1472	44	120-1827	48	120-1930	51	130-1199	89	130-1320	105	130-1656	106
120-1473	44	120-1828	48	120-1931	51	130-1205	78	130-1322	111	130-1657	90
120-1476	133	120-1829	48	120-1932	51	130-1206	78	130-1323	111	130-1658	90
120-1477	43	120-1830	48	120-1933	65	130-1207	78	130-1334	74	130-1661	100
120-1478	43	120-1835	135	120-1934	65	130-1208	78	130-1336	74	130-1664	86
120-1479	43	120-1840	47	120-1935	65	130-1209	78	130-1339	74	130-1666	86
120-1480	43	120-1841	47	120-1936	65	130-1210	78	130-1340	74	130-1669	96
120-1481	43	120-1842	47	120-1942	49	130-1211	78	130-1342	74	130-1673	101
120-1483	55	120-1843	47	120-1943	49	130-1212	78	130-1356	93	130-1674	88
120-1486	53	120-1844	47	125-1032	139	130-1213	78	130-1384	82	130-1675	87
120-1487	54	120-1845	47	125-1033	138	130-1214	78	130-1385	82	130-1676	93
120-1493	66	120-1846	47	125-1034	138	130-1215	78	130-1386	82	130-1677	93
120-1495	66	120-1847	47	125-1035	138	130-1216	78	130-1488	71	130-1678	93
120-1496	66	120-1848	50	125-1037	139	130-1217	78	130-1493	101	130-1679	93
120-1514	66	120-1851	51	125-1039	139	130-1223	75	130-1496	112	130-1680	93
120-1515	66	120-1852	51	125-1041	72	130-1224	75	130-1497	112	130-1681	93
120-1516	66	120-1853	45	125-1042	72	130-1225	75	130-1498	112	130-1682	93
120-1517	66	120-1854	45	125-1043	140	130-1226	75	130-1499	112	130-1683	93
120-1519	66	120-1856	131	125-1044	140	130-1227	75	130-1501	107	130-1684	93
120-1723	54	120-1857	131	125-1045	140	130-1229	75	130-1502	107	130-1687	40
120-1758	47	120-1858	134	130-1024	108	130-1230	75	130-1503	107	130-1688	40
120-1759	47	120-1859	135	130-1026	108	130-1242	75	130-1504	111	130-1689	40
120-1760	47	120-1860	65	130-1035	103	130-1243	75	130-1505	111	130-1690	40
120-1761	47	120-1861	65	130-1036	93	130-1244	75	130-1506	111	130-1691	40
120-1762	47	120-1862	45	130-1037	93	130-1245	75	130-1507	107	130-1692	40
120-1763	47	120-1863	45	130-1038	93	130-1246	75	130-1511	103	130-1693	40
120-1764	47	120-1864	45	130-1039	93	130-1247	75	130-1518	92	130-1694	40
120-1765	47	120-1865	45	130-1040	93	130-1248	77	130-1522	103	130-1695	40
120-1766	47	120-1866	45	130-1041	93	130-1249	77	130-1544	105	130-1696	40
120-1767	47	120-1867	43	130-1042	93	130-1250	77	130-1546	105	130-1697	40
120-1768	66	120-1868	43	130-1043	93	130-1251	77	130-1547	103	130-1698	40
120-1769	130	120-1869	43	130-1044	93	130-1252	77	130-1549	40	130-1699	40
120-1770	130	120-1870	43	130-1062	93	130-1264	76	130-1550	40	130-1700	40
120-1771	130	120-1871	43	130-1063	91	130-1265	76	130-1551	40	130-1701	40
120-1772	130	120-1876	50	130-1064	70	130-1267	76	130-1552	106	130-1702	40
120-1777	60	120-1877	50	130-1065	70	130-1271	75	130-1553	106	130-1703	40
120-1778	60	120-1878	50	130-1066	70	130-1272	75	130-1554	74	130-1704	40
120-1779	60	120-1879	50	130-1068	69	130-1273	75	130-1555	74	130-1707	111
120-1780	60	120-1880	57	130-1069	69	130-1274	75	130-1557	97	130-1709	107
120-1781	55	120-1881	57	130-1070	69	130-1275	75	130-1577	112	130-1710	107
120-1782	53	120-1882	57	130-1071	69	130-1277	73	130-1589	69	130-1712	100
120-1783	54	120-1883	57	130-1076	70	130-1278	73	130-1593	112	130-1715	36
120-1786	61	120-1884	57	130-1077	70	130-1280	73	130-1599	97	130-1716	76
120-1787	44	120-1885	57	130-1078	70	130-1281	73	130-1600	97	130-1782	104
120-1788	44	120-1889	61	130-1173	82	130-1282	73	130-1601	97	130-1783	103
120-1789	44	120-1890	61	130-1176	86	130-1283	73	130-1602	108	130-1787	40
120-1790	44	120-1891	61	130-1177	86	130-1284	73	130-1605	80	130-1788	40
120-1791	46	120-1892	61	130-1178	86	130-1285	73	130-1606	80	130-1793	92
120-1792	46	120-1893	63	130-1181	83	130-1286	73	130-1607	80	130-1794	73
120-1793	46	120-1894	63	130-1182	83	130-1287	73	130-1608	80	130-1800	91
120-1794	46	120-1895	63	130-1183	82	130-1288	73	130-1610	83	130-1802	96

INDEKS INDEX	STR. PAGE	INDEKS INDEX	STR. PAGE	INDEKS INDEX	STR. PAGE	INDEKS INDEX	STR. PAGE	INDEKS INDEX	STR. PAGE	INDEKS INDEX	STR. PAGE
130-1803	96	140-1015	95	150-1060	115	150-1176	273	150-1410	122	160-1274	146
130-1804	104	140-1016	95	150-1061	115	150-1177	118	150-1411	122	160-1308	174
130-1806	80	140-1017	95	150-1062	115	150-1178	118	150-1412	122	160-1309	174
130-1807	98	140-1018	95	150-1063	115	150-1180	118	150-1416	123	160-1310	174
130-1808	98	140-1019	95	150-1064	115	150-1181	118	150-1417	127	160-1311	174
130-1809	98	140-1020	95	150-1065	115	150-1182	118	150-1418	127	160-1312	175
130-1811	70	140-1021	95	150-1066	115	150-1187	124	150-1419	122	160-1313	175
130-1812	110	140-1022	95	150-1068	116	150-1188	124	150-1420	122	160-1314	175
130-1813	110	140-1023	95	150-1069	116	150-1190	124	150-1421	122	160-1315	175
130-1814	40	140-1024	95	150-1070	116	150-1191	124	150-1422	122	160-1316	175
130-1818	98	140-1025	95	150-1071	116	150-1192	124	150-1423	123	160-1317	175
130-1819	98	140-1026	95	150-1072	116	150-1193	124	150-1424	123	160-1318	175
130-1820	110	140-1027	95	150-1073	116	150-1206	273	150-1425	123	160-1319	175
130-1822	88	140-1028	95	150-1074	116	150-1210	273	150-1426	123	160-1339	170
130-1823	87	140-1029	95	150-1075	116	150-1222	122	150-1427	123	160-1340	170
130-1825	80	140-1032	95	150-1076	116	150-1223	122	150-1428	123	160-1346	168
130-1828	111	140-1033	95	150-1077	116	150-1229	121	150-1429	125	160-1347	168
130-1829	111	140-1034	95	150-1078	116	150-1230	121	150-1430	125	160-1348	168
130-1830	111	140-1046	94	150-1079	116	150-1231	121	150-1431	125	160-1349	168
130-1831	110	140-1048	95	150-1080	116	150-1232	121	150-1433	125	160-1350	168
130-1833	71	140-1049	95	150-1081	116	150-1233	121	150-1434	125	160-1351	168
130-1834	71	140-1050	95	150-1082	116	150-1234	121	150-1435	259	160-1352	168
130-1844	74	140-1052	95	150-1083	116	150-1235	121	150-1436	258	160-1353	168
130-1845	74	140-1053	95	150-1084	116	150-1236	121	150-1437	258	160-1354	168
130-1846	74	140-1057	92	150-1085	116	150-1237	121	150-1438	258	160-1355	168
130-1847	74	140-1058	92	150-1086	116	150-1238	126	150-1439	258	160-1356	168
130-1848	83	140-1059	94	150-1087	116	150-1239	122	150-1440	127	160-1377	166
130-1851	96	140-1060	92	150-1090	258	150-1241	258	150-1441	127	160-1382	195
130-1852	91	140-1064	94	150-1131	126	150-1243	127	150-1442	127	160-1387	195
130-1854	101	140-1065	94	150-1134	126	150-1244	127	150-1443	273	160-1402	159
130-1855	71	150-1026	124	150-1136	126	150-1254	121	150-1444	259	160-1403	159
130-1856	81	150-1027	124	150-1137	126	150-1261	258	150-1445	259	160-1404	159
130-1857	81	150-1028	114	150-1138	126	150-1262	258	150-1446	259	160-1405	159
130-1858	81	150-1029	114	150-1140	126	150-1285	118	150-1447	125	160-1407	163
130-1859	81	150-1030	114	150-1141	126	150-1287	119	150-1448	125	160-1409	163
130-1860	81	150-1031	114	150-1145	273	150-1288	119	150-1449	125	160-1410	161
130-1861	81	150-1032	114	150-1146	273	150-1290	120	150-1450	125	160-1460	169
130-1862	88	150-1033	114	150-1147	273	150-1309	114	150-1451	125	160-1461	206
130-1863	97	150-1034	114	150-1148	273	150-1310	114	150-1452	126	160-1462	203
130-1864	69	150-1036	114	150-1149	273	150-1311	115	150-1453	126	160-1463	203
130-1881	109	150-1037	114	150-1151	273	150-1323	122	160-1001	170	160-1464	203
130-1882	109	150-1038	114	150-1152	273	150-1325	273	160-1002	170	160-1466	202
130-1883	85	150-1039	114	150-1154	273	150-1329	122	160-1003	170	160-1467	202
130-1885	85	150-1040	114	150-1155	273	150-1365	115	160-1025	162	160-1468	202
130-1890	40	150-1041	114	150-1156	273	150-1366	118	160-1026	162	160-1469	202
130-1891	40	150-1042	114	150-1157	273	150-1373	118	160-1027	162	160-1470	202
130-1892	85	150-1043	114	150-1159	273	150-1374	127	160-1028	162	160-1472	202
130-1893	85	150-1044	114	150-1160	273	150-1377	119	160-1032	169	160-1473	208
130-1899	75	150-1045	114	150-1161	273	150-1378	119	160-1033	169	160-1474	208
130-1900	75	150-1046	114	150-1162	273	150-1381	123	160-1034	169	160-1475	202
130-1901	75	150-1048	114	150-1164	273	150-1382	123	160-1035	169	160-1476	202
130-1902	103	150-1049	115	150-1166	273	150-1383	123	160-1066	155	160-1479	203
130-1903	72	150-1050	115	150-1167	273	150-1399	123	160-1068	161	160-1484	170
130-1904	109	150-1051	115	150-1168	273	150-1400	123	160-1069	152	160-1488	165
130-1905	109	150-1052	115	150-1169	273	150-1401	123	160-1070	152	160-1489	165
130-1906	109	150-1053	115	150-1170	273	150-1402	123	160-1071	155	160-1490	165
130-1907	109	150-1054	115	150-1171	273	150-1405	122	160-1072	154	160-1514	164
130-1908	96	150-1056	115	150-1172	273	150-1406	122	160-1124	165	160-1517	171
140-1009	94	150-1057	115	150-1173	273	150-1407	122	160-1125	165	160-1518	171
140-1010	94	150-1058	115	150-1174	273	150-1408	122	160-1266	147	160-1519	171
140-1011	94	150-1059	115	150-1175	273	150-1409	122	160-1268	147	160-1520	171

INDEKS INDEX	STR. PAGE	INDEKS INDEX	STR. PAGE	INDEKS INDEX	STR. PAGE	INDEKS INDEX	STR. PAGE	INDEKS INDEX	STR. PAGE	INDEKS INDEX	STR. PAGE
160-1521	171	160-1986	158	160-2196	163	170-1013	212	170-1551	213	170-1878	260
160-1619	168	160-1994	158	160-2202	207	170-1014	212	170-1553	219	170-1881	231
160-1722	171	160-1998	198	160-2203	207	170-1015	212	170-1562	262	170-1883	272
160-1764	167	160-1999	198	160-2204	249	170-1022	220	170-1565	262	170-1884	264
160-1769	155	160-2000	142	160-2205	249	170-1023	220	170-1566	262	170-1885	264
160-1770	152	160-2001	142	160-2206	249	170-1027	229	170-1568	262	170-1886	264
160-1774	154	160-2002	143	160-2207	204	170-1031	230	170-1578	262	170-1887	264
160-1783	145	160-2008	176	160-2208	182	170-1033	231	170-1582	262	170-1888	271
160-1810	163	160-2009	176	160-2209	186	170-1034	229	170-1585	262	170-1893	271
160-1812	155	160-2011	163	160-2214	183	170-1041	225	170-1586	262	170-1894	271
160-1813	158	160-2012	146	160-2215	183	170-1044	222	170-1587	262	170-1906	272
160-1816	145	160-2030	197	160-2216	205	170-1045	223	170-1588	262	170-1907	265
160-1833	164	160-2031	198	160-2217	186	170-1047	224	170-1589	262	170-1908	265
160-1839	165	160-2032	196	160-2222	144	170-1049	223	170-1595	261	170-1909	265
160-1861	166	160-2033	197	160-2223	205	170-1050	224	170-1597	261	170-1910	265
160-1871	168	160-2035	199	160-2224	172	170-1370	180	170-1598	261	170-1911	265
160-1872	168	160-2037	196	160-2228	204	170-1373	180	170-1601	261	170-1912	266
160-1873	168	160-2038	200	160-2229	182	170-1375	180	170-1604	262	170-1913	266
160-1874	168	160-2055	164	160-2230	149	170-1377	180	170-1605	260	170-1915	266
160-1876	144	160-2079	151	160-2231	153	170-1379	180	170-1606	260	170-1916	266
160-1878	175	160-2085	150	160-2232	201	170-1381	184	170-1607	260	170-1917	270
160-1881	171	160-2086	166	160-2234	99	170-1382	184	170-1608	260	170-1918	270
160-1883	164	160-2095	142	160-2235	99	170-1383	184	170-1610	260	170-1980	260
160-1892	188	160-2102	99	160-2236	99	170-1384	184	170-1611	260	170-1981	260
160-1900	164	160-2107	151	160-2237	173	170-1385	184	170-1612	260	170-1982	260
160-1901	164	160-2109	157	160-2238	99	170-1386	184	170-1613	260	170-1983	260
160-1902	206	160-2110	207	160-2240	201	170-1387	184	170-1614	260	170-1984	260
160-1903	206	160-2111	208	160-2241	201	170-1414	268	170-1615	260	170-1985	260
160-1911	151	160-2112	208	160-2242	201	170-1415	268	170-1616	260	170-1986	260
160-1916	144	160-2114	200	160-2243	201	170-1416	213	170-1617	260	170-1987	260
160-1924	156	160-2115	196	160-2244	201	170-1417	213	170-1618	260	170-1988	260
160-1925	151	160-2116	167	160-2245	201	170-1419	268	170-1619	260	170-1989	259
160-1926	98	160-2127	157	160-2248	99	170-1420	267	170-1626	219	170-1993	270
160-1927	98	160-2138	146	160-2249	99	170-1421	267	170-1627	219	170-1994	270
160-1928	147	160-2140	163	160-2250	99	170-1422	269	170-1628	219	170-1995	270
160-1930	188	160-2151	199	160-2251	99	170-1423	269	170-1629	219	170-1996	270
160-1948	172	160-2154	160	160-2252	99	170-1424	269	170-1630	219	170-2090	264
160-1949	172	160-2155	160	160-2253	153	170-1425	269	170-1631	219	170-2091	264
160-1950	172	160-2156	159	160-2254	161	170-1426	268	170-1632	219	170-2102	227
160-1951	172	160-2157	159	160-2257	173	170-1428	213	170-1634	211	170-2105	194
160-1955	154	160-2158	159	160-2258	173	170-1429	213	170-1646	262	170-2120	181
160-1961	172	160-2159	159	160-2259	173	170-1430	214	170-1673	262	170-2121	262
160-1962	176	160-2160	160	160-2260	173	170-1431	214	170-1676	262	170-2122	262
160-1963	176	160-2162	170	160-2261	173	170-1432	214	170-1678	262	170-2128	102
160-1964	176	160-2163	169	160-2262	202	170-1440	210	170-1681	262	170-2135	102
160-1965	176	160-2164	203	160-2263	159	170-1441	210	170-1682	262	170-2150	178
160-1966	176	160-2165	206	160-2264	159	170-1442	210	170-1683	262	170-2153	265
160-1967	176	160-2175	174	160-2265	172	170-1443	210	170-1684	262	170-2185	185
160-1968	176	160-2176	165	160-2266	161	170-1444	210	170-1685	262	170-2186	178
160-1969	176	160-2177	165	160-2267	162	170-1445	210	170-1686	261	170-2187	178
160-1970	188	160-2179	143	160-2269	153	170-1446	210	170-1687	261	170-2188	178
160-1972	142	160-2180	143	160-2270	153	170-1448	210	170-1692	222	170-2207	180
160-1973	154	160-2183	171	160-2271	205	170-1449	210	170-1694	231	170-2208	219
160-1975	151	160-2184	157	160-2272	175	170-1450	210	170-1864	210	170-2209	184
160-1976	152	160-2188	156	160-2273	175	170-1451	210	170-1865	210	170-2210	194
160-1977	145	160-2189	150	160-2274	167	170-1453	210	170-1866	210	170-2211	194
160-1979	168	160-2190	156	160-2275	167	170-1459	211	170-1867	210	170-2215	214
160-1980	195	160-2191	150	160-2276	45	170-1462	181	170-1869	211	170-2216	211
160-1983	195	160-2192	45	160-2277	205	170-1464	181	170-1870	185	170-2217	211
160-1984	195	160-2194	98	160-2278	204	170-1503	219	170-1876	260	170-2218	179
160-1985	151	160-2195	98	170-1012	212	170-1548	225	170-1877	260	170-2219	230

INDEKS INDEX	STR. PAGE	INDEKS INDEX	STR. PAGE	INDEKS INDEX	STR. PAGE	INDEKS INDEX	STR. PAGE	INDEKS INDEX	STR. PAGE	INDEKS INDEX	STR. PAGE
170-2220	231	170-2309	260	170-2396	238	170-2469	243	170-2538	236	170-2596	265
170-2221	224	170-2310	260	170-2397	238	170-2470	243	170-2539	236	170-2597	265
170-2225	194	170-2311	260	170-2398	238	170-2471	236	170-2540	236	170-2598	265
170-2227	219	170-2312	260	170-2399	238	170-2472	183	170-2541	246	171-1027	256
170-2228	233	170-2313	260	170-2400	238	170-2473	179	170-2542	246	171-1028	256
170-2229	233	170-2314	260	170-2401	238	170-2474	178	170-2543	246	171-1029	257
170-2230	233	170-2320	247	170-2402	238	170-2475	239	170-2544	246		
170-2231	233	170-2321	247	170-2403	238	170-2476	240	170-2545	246		
170-2232	233	170-2322	247	170-2404	238	170-2477	240	170-2546	246		
170-2233	233	170-2325	217	170-2408	247	170-2478	240	170-2547	246		
170-2234	232	170-2326	182	170-2409	247	170-2479	240	170-2548	246		
170-2235	232	170-2327	182	170-2410	247	170-2480	232	170-2549	246		
170-2236	232	170-2328	261	170-2411	247	170-2481	240	170-2550	246		
170-2237	232	170-2336	270	170-2425	179	170-2482	241	170-2551	246		
170-2238	232	170-2340	213	170-2426	253	170-2483	240	170-2552	246		
170-2239	232	170-2341	254	170-2427	253	170-2484	240	170-2553	250		
170-2240	235	170-2342	254	170-2428	182	170-2485	241	170-2554	250		
170-2241	235	170-2346	259	170-2429	234	170-2486	241	170-2555	250		
170-2242	235	170-2347	261	170-2430	234	170-2491	254	170-2556	251		
170-2243	236	170-2348	187	170-2431	209	170-2492	254	170-2557	248		
170-2244	236	170-2349	187	170-2432	209	170-2493	209	170-2558	248		
170-2254	219	170-2350	209	170-2433	209	170-2494	209	170-2559	251		
170-2256	214	170-2353	210	170-2434	189	170-2495	209	170-2560	234		
170-2257	267	170-2354	210	170-2435	189	170-2501	262	170-2561	234		
170-2258	267	170-2355	210	170-2436	189	170-2502	262	170-2562	234		
170-2260	232	170-2356	210	170-2437	189	170-2503	262	170-2563	234		
170-2261	232	170-2357	210	170-2438	189	170-2504	262	170-2564	226		
170-2262	233	170-2358	210	170-2439	189	170-2507	212	170-2565	226		
170-2263	233	170-2359	210	170-2440	183	170-2508	193	170-2567	190		
170-2264	235	170-2360	210	170-2441	185	170-2509	260	170-2568	190		
170-2265	235	170-2361	210	170-2442	185	170-2510	262	170-2569	191		
170-2266	235	170-2362	210	170-2443	223	170-2511	235	170-2570	191		
170-2267	235	170-2363	210	170-2444	228	170-2512	235	170-2571	216		
170-2268	235	170-2364	210	170-2445	227	170-2513	235	170-2572	216		
170-2269	234	170-2365	210	170-2446	227	170-2514	235	170-2573	187		
170-2270	234	170-2366	210	170-2447	227	170-2515	244	170-2574	189		
170-2271	235	170-2367	210	170-2448	227	170-2516	244	170-2575	237		
170-2272	235	170-2368	226	170-2449	225	170-2517	244	170-2576	237		
170-2273	235	170-2370	221	170-2450	225	170-2518	244	170-2577	237		
170-2274	235	170-2371	221	170-2451	262	170-2519	245	170-2578	237		
170-2275	189	170-2372	228	170-2452	262	170-2520	245	170-2579	237		
170-2276	210	170-2373	212	170-2453	262	170-2521	245	170-2580	237		
170-2277	210	170-2378	232	170-2454	262	170-2522	245	170-2581	237		
170-2278	210	170-2380	236	170-2455	262	170-2524	192	170-2582	237		
170-2279	217	170-2383	242	170-2456	240	170-2525	215	170-2583	237		
170-2281	217	170-2384	242	170-2457	240	170-2526	215	170-2584	237		
170-2295	102	170-2385	242	170-2458	243	170-2527	215	170-2585	252		
170-2296	208	170-2386	242	170-2459	243	170-2528	215	170-2586	252		
170-2298	224	170-2387	242	170-2460	239	170-2529	215	170-2587	211		
170-2299	181	170-2388	242	170-2461	239	170-2530	245	170-2588	211		
170-2300	261	170-2389	242	170-2462	239	170-2531	245	170-2589	211		
170-2301	261	170-2390	243	170-2463	239	170-2532	245	170-2590	211		
170-2302	180	170-2391	238	170-2464	239	170-2533	245	170-2591	211		
170-2303	210	170-2392	238	170-2465	239	170-2534	244	170-2592	189		
170-2306	217	170-2393	238	170-2466	239	170-2535	244	170-2593	265		
170-2307	260	170-2394	238	170-2467	239	170-2536	244	170-2594	265		
170-2308	260	170-2395	238	170-2468	239	170-2537	236	170-2595	265		

Przedstawiona oferta ma charakter informacyjny i nie stanowi oferty handlowej w rozumieniu Art.66 §1 Kodeksu Cywilnego. Rzeczywisty produkt może się nieznacznie różnić od wizerunku prezentowanego na zdjęciach.

This catalog is for information purposes only and does not constitute an offer within the meaning of the Civil Code (Art. 66 par. 1) of the Republic of Poland. Photos may differ from products available for purchase.

## Table of contents

abacus .....	101	erasers .....	98	pencils .....	167
adhesive stickers .....	114	expanding briefcase .....	49	pencils, mechanical .....	166
adhesive tape, office .....	71	expanding wallet .....	49	permanent markers .....	175
adhesive tape, packing .....	75	face paint .....	192	photo paper .....	117
adhesive tapes, special use .....	77	felt deco .....	242	plasticine .....	214
aprons .....	248	fibre pens .....	195	pompoms .....	246
BABY brush .....	189	fibre pens, creative .....	196	poster paint stick .....	191
BABY crayons .....	186	fibre pens, perfume .....	207	protractor .....	107
BABY fibre pens .....	188	fineliners .....	168	punches .....	18
BABY paints .....	189	finger dumpers .....	92	punches Alpha .....	14
BABY pencils .....	186	flute .....	98	punches ColorTouch .....	7
ball pen Corretto, erasable .....	160	fountain pens .....	169	punches Dynamic .....	10
ball pen Corvina Classic .....	159	gel pens .....	162	punches Energy .....	9
ball pen refills .....	164	Glass Deco paints .....	222	punches Energy .....	9
ball pens .....	148	glitter glue .....	229, 233	punches Galaxy .....	16
ball pens color sets .....	163	glitter powder .....	232	punches Ha! .....	6
ball pens multicolor .....	161	glue stick .....	69	punches professional .....	20
balloon accessories .....	261	glue, dots .....	71	punches Save Force .....	12
balloons .....	262	glue, liquid .....	70	Redis set .....	103
balloons, fancy .....	262	graphites for mechanical pencil .....	166	report files .....	46
binder clips .....	35, 36	highlighters .....	171	rubber bands .....	36, 93
bookends .....	54	i-Clay .....	218	ruler, engineering scale .....	110
brushes .....	267	index dividers, color .....	49	rulers .....	109
brushes, school .....	213	indicator tags .....	127	school sets .....	255
bubble wrap .....	92	ink .....	170	scissors, craft .....	88
burmester set .....	107	ink erasers .....	170	scissors, office .....	80
cable organizers .....	65	key boxes .....	65	scissors, plastic .....	88
calculator, graphical .....	137	label removal spray .....	139	scissors, school .....	86
calculator, scientific .....	137	laminating pouch .....	45	screen cleaner .....	138
calculators, desk .....	132	letter indexes .....	124	sharpeners .....	96
calculators, pocket .....	130	letter knife .....	89	sharpeners, automatic .....	96
canvas .....	259	magic sand .....	217	spray duster .....	139
cash boxes .....	64	magnets .....	40	stamp ink .....	95
CD/DVD marker .....	175	magnifying glass .....	98	stamp pads .....	95
chalk .....	102	markers, creative .....	201	stamps .....	209
charcoal in wood .....	271	metallic crayons .....	190	staple removers .....	32
charcoal, natural .....	271	metallic fibre pens .....	191	staplers Alpha .....	15
chenille stems .....	246	metallic pencils .....	190	staplers ColorTouch .....	7
cleaning gel .....	138	modelling material .....	216	staplers Dynamic .....	11
cleaning wipes .....	138	name badges .....	91	staplers for #10 staples .....	24
clear storage envelopes .....	44	name card holder .....	66	staplers for #24/6, 26/6 staples .....	25
clipboard .....	50	notebooks .....	122	staplers Galaxy .....	17
clipboards with cover NOTOdesk .....	50	notebooks with rubber band .....	123	staplers Ha! .....	6
color pencils .....	178	notebooks, sequin .....	123	staplers In-Touch .....	8
coloring sets .....	253	notebooks, spiral .....	112	staplers professional .....	27
compasses .....	103	notes spiral .....	125	staplers Save Force .....	13
confetti sequins .....	235	numbering machines .....	94	staplers SOFTouch .....	12
cork boards .....	66	office pins .....	35, 39	staples .....	32
correction fluid .....	147	packing tape dispenser .....	76	stationery organizer .....	51
correction pens GRAND .....	147	paint markers .....	176	stationery organizer .....	51
correction pens OVAL .....	145	painting cup .....	213	stickers for labeling machines .....	116
correction tapes GRAND .....	146	painting palettes .....	270	stickers, convex .....	240
correction tapes OVAL .....	142	paints, acrylic .....	265	stickers, decor 3D .....	243
correspondence books .....	124	paints, gouache .....	266	stickers, felt .....	242
counting rods .....	101	paints, oil .....	266	stickers, foam .....	242
crayons, Twist-up .....	194	paints, poster .....	211	sticky notes .....	125
creative sets .....	250	paints, tempera .....	210	sticky tack .....	71
creative sets jewelry .....	252	paints, water color .....	212, 263	stretch foil .....	92
crepe paper .....	260	paper clips .....	34, 36	tape dispenser, handheld .....	72
date stamps .....	94	paper cube .....	125	tape dispensers .....	72
decorative tapes .....	247	paper knife blades .....	89	technical compass sets .....	106
desk organizers .....	57	paper knives .....	89	technical pad .....	258
desk organizers, wire mesh .....	52	paper Prisma textured .....	273	technical pencil .....	167
diamonds adhesive .....	238	paper, Art Deco .....	273	thumb tacks .....	35, 38
display book .....	45	pastels, dry .....	264	tissue paper .....	259
display book .....	48	pastels, oil .....	185, 262	triangle .....	107
document cabinets, metal .....	60	pattern tape .....	247	wax crayons .....	184
document cabinets, plastic .....	61	pearls adhesive .....	237	whistle .....	98
document case .....	42	pen cartridges .....	170	whiteboard .....	66
document tray .....	51	pen holder .....	248	whiteboard cleaner .....	139
drawing pad .....	258	pencil case roll-up .....	251	whiteboard markers .....	174
drawing sets .....	249	pencil cases equipped .....	256	wiggle eyes .....	234
drawing sets .....	108	pencil G873056 .....	272	wooden clamp .....	244
drawing tubes .....	270	pencil grip .....	98	wooden deco .....	244
drawing utensils, flexible .....	110	pencil organizer Ha! .....	51		
eraser, kneadable .....	272	pencil, carpenter .....	166		

## Lista produktów

akcesoria do balonów .....	261	korektor w butelce.....	147	płyn do ekranów .....	138
aktówka harmonijkowa.....	49	korektory w pisaku Grand .....	147	płyn do tablic .....	139
atrament .....	170	korektory w pisaku Oval .....	145	płyn do usuwania etykiet .....	139
balony fantazyjne.....	262	korektory w taśmie Grand .....	146	podajnik do taśmy .....	72
balony tradycyjne.....	262	korektory w taśmie Oval .....	142	podstawki do książek.....	54
bibuła dekoracyjna marszczona .....	260	koszka biurowa .....	125	poduszki do pieczętek i stempli.....	95
bibuła gładka .....	259	kreda .....	102	pojemnik na długopisy Ha!.....	51
blok rysunkowy .....	258	kredek dla maluchów .....	186	pojemnik na dokumenty .....	51
blok techniczny .....	258	kredek do twarzy .....	192	pojemniki na kable .....	65
bloki malarskie Art Deco.....	273	kredek metaliczne .....	190	pompony kreatywne .....	246
bruliony .....	122	kredek ołówkowe.....	178	przekładki indeksujące.....	49
cekiny confetti .....	235	kredek świecowe .....	184	przybornik na długopisy.....	248
cekiny oczka.....	234	kredek wykręcane .....	194	przybornik płaski .....	51
chusteczki czyszczące .....	138	kropki mocujące żelowe .....	71	przyborniki plastikowe .....	57
ciенокopisy .....	168	krzywki .....	107	przyborniki z siatki metalowej.....	52
cyrkle.....	103	kubek niekapek .....	213	przybory geometryczne elastyczne .....	110
datowniki .....	94	liczydła.....	101	pudełka na wizytówki .....	66
deska z klipem .....	50	linijka skalówka budowlana.....	110	rozszywacze .....	32
diamenciki samoprzylepne .....	238	linijki .....	109	skoroszyty .....	46
długopis Corvina Classic.....	159	magiczny piasek.....	217	skorowidze alfabetyczne.....	124
długopisy wymazywalny Corretto .....	160	magnesy.....	40	spinacze .....	34, 36
długopisy .....	148	marker do płyt CD/DVD .....	175	spinacze drewniane.....	244
długopisy kolorowe zestawy .....	163	markery kreatywne .....	201	spray czyszczący.....	139
długopisy wielokolorowe .....	161	markery olejowe.....	176	stempelki.....	209
długopisy żelowe .....	162	markery permanentne .....	175	syпки brokat .....	232
druciki kreatywne .....	246	markery tablicowe .....	174	szafki metalowe .....	60
dzienniki korespondencyjne.....	124	masa do modelowania .....	216	szafki na klucze .....	65
dziurkacze .....	18	masa mocująca .....	71	szafki plastikowe .....	61
dziurkacze Alpha .....	14	masa plastyczna Ciasto-Plasto®.....	218	szko powiększające.....	98
dziurkacze ColorTouch .....	7	naboje do piór .....	170	szpilki .....	35, 39
dziurkacze Dynamic.....	10	naklejki dekoracyjne 3D.....	243	szuflada na dokumenty .....	51
dziurkacze Energy.....	9	naklejki filcowe .....	242	tablica suchościeralna .....	66
dziurkacze Energy.....	9	naklejki piankowe .....	242	tablice korkowe w ramie drewnianej .....	66
dziurkacze Galaxy.....	16	naklejki wypukłe .....	240	taśma biurowa .....	71
dziurkacze Ha! .....	6	notatniki z cekinami.....	123	taśma pakowa .....	75
dziurkacze Save Force .....	12	notatniki z gumką .....	123	taśmy dekoracyjne.....	247
dziurkacze specjalistyczne .....	20	notesy na spirali .....	125	taśmy samoprzylepne, specjalistyczne .....	77
ekierka.....	107	notesy samoprzylepne.....	125	teczka harmonijkowa .....	49
etykiety do metkownic.....	116	noże do papieru.....	89	teczki ofertowe .....	48
etykiety samoprzylepne .....	116	nożyczki biurowe .....	80	teczki z klipem NOTOdesk .....	50
farby akrylowe .....	266	nożyczki dekoracyjne .....	88	temperówki.....	96
farby akwarelowe.....	212, 263	nożyczki plastikowe .....	88	temperówki automatyczne .....	96
farby dla maluchów .....	189	nożyczki szkolne .....	86	tuby kreślarskie .....	270
farby gwasz .....	266	nóż do kopert .....	89	tusz do pieczętek i stempli.....	95
farby olejne .....	265	numeratory .....	94	uchwyt na ołówek .....	98
farby plakatowe .....	211	oklejarka do taśmy pakowej.....	76	uchwyt do taśmy .....	72
farby tempery .....	210	oówek Kubuś .....	272	węgiel naturalny.....	271
farby w sztyfcie .....	191	oówek stolarski .....	166	węgiel w drewnie.....	271
farby witrażowe .....	222	oówek techniczny.....	167	wkłady do długopisów .....	164
fartuszki ochronne .....	248	oówki .....	167	wymazywacze do atramentu.....	170
flet prosty .....	98	oówki automatyczne .....	166	wzorki w taśmie .....	247
folia bąbelkowa.....	92	ozdoby drewniane.....	244	zakładki indeksujące .....	127
folia do laminacji.....	45	ozdoby filcowe .....	242	zakreślacze .....	171
folia stretch .....	92	palety malarskie.....	270	zestaw Redis.....	103
grafity do ołówków automatycznych.....	166	papier fakturowany prisma.....	273	zestawy do kolorowania .....	253
gumka chlebowa .....	272	papiery fotograficzne.....	117	zestawy geometryczne.....	108
gumki do wymazywania .....	98	pastele olejne .....	185, 262	zestawy kreatywne biżuteria.....	252
gumki recepturki.....	36, 93	pastele suche .....	264	zestawy plastyczne .....	250
gwizdek .....	98	patyczki do liczenia.....	101	zestawy przyborów kreślarskich .....	106
identyfikatory.....	91	perelki samoprzylepne .....	237	zestawy szkolne .....	255
kalkulator graficzny .....	137	pióra.....	169	zszywacze Alpha.....	15
kalkulator naukowy .....	137	piórniki z wyposażeniem .....	251	zszywacze ColorTouch.....	7
kalkulatory biurowe.....	132	piórniki z wyposażeniem .....	256	zszywacze Dynamic .....	11
kalkulatory kieszonkowe .....	130	pisaki .....	195	zszywacze Galaxy.....	17
kasetki na pieniądze .....	64	pisaki dla maluchów .....	188	zszywacze Ha!.....	6
kątomierz .....	107	pisaki kreatywne.....	196	zszywacze In-Touch.....	8
klej w płynie.....	70	pisaki metaliczne .....	191	zszywacze na zszywki #10.....	24
klej w sztyfcie .....	69	pisaki kreatywne.....	196	zszywacze na zszywki #24/6, 26/6 .....	25
klej z brokatem .....	229, 233	pisaki metaliczne .....	191	zszywacze Save Force.....	13
klipy.....	35, 36	pisaki metaliczne .....	191	zszywacze SOFTouch .....	12
kolorowanki .....	249	pisaki metaliczne .....	191	zszywacze specjalistyczne.....	27
kołozeszyty, kołobruliony.....	112	pisaki metaliczne .....	191	zszywki.....	32
koperty z gumką.....	45	pisaki metaliczne .....	191	zwilżacze do palców .....	92
koperty z zamkiem strunowym .....	44	pisaki metaliczne .....	191	żel czyszczący.....	138
koperty zatraskowe.....	42	pisaki metaliczne .....	191		



[www.kwtrade.pl](http://www.kwtrade.pl)

[www.fiorelki.pl](http://www.fiorelki.pl)

[www.najlepszyklej.pl](http://www.najlepszyklej.pl)

[www.korektoryoval.pl](http://www.korektoryoval.pl)

[www.yellowone.pl](http://www.yellowone.pl)

[www.toor.com.pl](http://www.toor.com.pl)